THERMODYNAMICS
AND
CHEMISTRY

SECOND EDITION



HOWARD DEVOE

Thermodynamics and Chemistry

Second Edition
Version 9a, October 2019

Howard DeVoe

Associate Professor of Chemistry Emeritus
University of Maryland, College Park, Maryland
hdevoe@umd.edu

The first edition of this book was previously published by Pearson Education, Inc. It was copyright ©2001 by Prentice-Hall, Inc.

The second edition, version 9a is copyright ©2019 by Howard DeVoe.



This work is licensed under a Creative Commons Attribution 4.0 International License:

<https://creativecommons.org/licenses/by/4.0/>

The book was typeset using the \LaTeX typesetting system and the memoir class. Most of the figures were produced with PSTricks, a related software program. The fonts are Adobe Times, MathTime, and Computer Modern Typewriter.

I thank the Department of Chemistry and Biochemistry, University of Maryland, College Park, Maryland for hosting the Web site for this book:

<http://www.chem.umd.edu/thermobook>

SHORT CONTENTS

Biographical Sketches	15
Preface to the Second Edition	16
From the Preface to the First Edition	17
1 Introduction	19
2 Systems and Their Properties	27
3 The First Law	57
4 The Second Law	105
5 Thermodynamic Potentials	138
6 The Third Law and Cryogenics	153
7 Pure Substances in Single Phases	166
8 Phase Transitions and Equilibria of Pure Substances	195
9 Mixtures	225
10 Electrolyte Solutions	287
11 Reactions and Other Chemical Processes	304
12 Equilibrium Conditions in Multicomponent Systems	367
13 The Phase Rule and Phase Diagrams	418
14 Galvanic Cells	449
Appendix A Definitions of the SI Base Units	470
Appendix B Physical Constants	472

Appendix C	Symbols for Physical Quantities	473
Appendix D	Miscellaneous Abbreviations and Symbols	477
Appendix E	Calculus Review	480
Appendix F	Mathematical Properties of State Functions	482
Appendix G	Forces, Energy, and Work	487
Appendix H	Standard Molar Thermodynamic Properties	505
Appendix I	Answers to Selected Problems	508
	Bibliography	512
	Index	521

CONTENTS

Biographical Sketches	15
Preface to the Second Edition	16
From the Preface to the First Edition	17
1 Introduction	19
1.1 Physical Quantities, Units, and Symbols	19
1.1.1 The International System of Units	19
1.1.2 Amount of substance and amount	19
1.1.3 The SI revision of 2019	20
1.1.4 Derived units and prefixes	21
1.2 Quantity Calculus	22
1.3 Dimensional Analysis	24
Problem	26
2 Systems and Their Properties	27
2.1 The System, Surroundings, and Boundary	27
2.1.1 Extensive and intensive properties	28
2.2 Phases and Physical States of Matter	30
2.2.1 Physical states of matter	30
2.2.2 Phase coexistence and phase transitions	31
2.2.3 Fluids	32
2.2.4 The equation of state of a fluid	33
2.2.5 Virial equations of state for pure gases	34
2.2.6 Solids	36
2.3 Some Basic Properties and Their Measurement	36
2.3.1 Mass	36
2.3.2 Amount of substance	37
2.3.3 Volume	38
2.3.4 Density	39
2.3.5 Pressure	39
2.3.6 Temperature	40
2.4 The State of the System	46

2.4.1	State functions and independent variables	47
2.4.2	An example: state functions of a mixture	47
2.4.3	More about independent variables	48
2.4.4	Equilibrium states	49
2.4.5	Steady states	51
2.5	Processes and Paths	51
2.6	The Energy of the System	53
2.6.1	Energy and reference frames	53
2.6.2	Internal energy	54
	Problems	56
3	The First Law	57
3.1	Heat, Work, and the First Law	57
3.1.1	The concept of thermodynamic work	58
3.1.2	Work coefficients and work coordinates	60
3.1.3	Heat and work as path functions	61
3.1.4	Heat and heating	62
3.1.5	Heat capacity	63
3.1.6	Thermal energy	63
3.2	Spontaneous, Reversible, and Irreversible Processes	63
3.2.1	Reversible processes	63
3.2.2	Reversibility and the surroundings	66
3.2.3	Irreversible processes	68
3.2.4	Purely mechanical processes	69
3.3	Heat Transfer	69
3.3.1	Heating and cooling	69
3.3.2	Spontaneous phase transitions	71
3.4	Deformation Work	71
3.4.1	Gas in a cylinder-and-piston device	72
3.4.2	Expansion work of a gas	75
3.4.3	Expansion work of an isotropic phase	76
3.4.4	Generalities	77
3.5	Applications of Expansion Work	77
3.5.1	The internal energy of an ideal gas	77
3.5.2	Reversible isothermal expansion of an ideal gas	78
3.5.3	Reversible adiabatic expansion of an ideal gas	78
3.5.4	Indicator diagrams	80
3.5.5	Spontaneous adiabatic expansion or compression	81
3.5.6	Free expansion of a gas into a vacuum	82
3.6	Work in a Gravitational Field	82
3.7	Shaft Work	84
3.7.1	Stirring work	85
3.7.2	The Joule paddle wheel	87
3.8	Electrical Work	89
3.8.1	Electrical work in a circuit	89
3.8.2	Electrical heating	91
3.8.3	Electrical work with a galvanic cell	92

3.9	Irreversible Work and Internal Friction	93
3.10	Reversible and Irreversible Processes: Generalities	97
	Problems	100
4	The Second Law	105
4.1	Types of Processes	105
4.2	Statements of the Second Law	106
4.3	Concepts Developed with Carnot Engines	109
4.3.1	Carnot engines and Carnot cycles	109
4.3.2	The equivalence of the Clausius and Kelvin–Planck statements	112
4.3.3	The efficiency of a Carnot engine	114
4.3.4	Thermodynamic temperature	117
4.4	The Second Law for Reversible Processes	119
4.4.1	The Clausius inequality	119
4.4.2	Using reversible processes to define the entropy	122
4.4.3	Alternative derivation of entropy as a state function	125
4.4.4	Some properties of the entropy	126
4.5	The Second Law for Irreversible Processes	127
4.5.1	Irreversible adiabatic processes	127
4.5.2	Irreversible processes in general	128
4.6	Applications	130
4.6.1	Reversible heating	130
4.6.2	Reversible expansion of an ideal gas	130
4.6.3	Spontaneous changes in an isolated system	131
4.6.4	Internal heat flow in an isolated system	131
4.6.5	Free expansion of a gas	132
4.6.6	Adiabatic process with work	133
4.7	Summary	133
4.8	The Statistical Interpretation of Entropy	134
	Problems	136
5	Thermodynamic Potentials	138
5.1	Total Differential of a Dependent Variable	138
5.2	Total Differential of the Internal Energy	139
5.3	Enthalpy, Helmholtz Energy, and Gibbs Energy	141
5.4	Closed Systems	143
5.5	Open Systems	145
5.6	Expressions for Heat Capacity	146
5.7	Surface Work	147
5.8	Criteria for Spontaneity	148
	Problems	151
6	The Third Law and Cryogenics	153
6.1	The Zero of Entropy	153
6.2	Molar Entropies	155
6.2.1	Third-law molar entropies	155
6.2.2	Molar entropies from spectroscopic measurements	158

6.2.3	Residual entropy	159
6.3	Cryogenics	160
6.3.1	Joule–Thomson expansion	160
6.3.2	Magnetization	162
	Problem	165
7	Pure Substances in Single Phases	166
7.1	Volume Properties	166
7.2	Internal Pressure	168
7.3	Thermal Properties	169
7.3.1	The relation between $C_{V,m}$ and $C_{p,m}$	170
7.3.2	The measurement of heat capacities	171
7.3.3	Typical values	176
7.4	Heating at Constant Volume or Pressure	176
7.5	Partial Derivatives with Respect to T , p , and V	179
7.5.1	Tables of partial derivatives	179
7.5.2	The Joule–Thomson coefficient	182
7.6	Isothermal Pressure Changes	182
7.6.1	Ideal gases	183
7.6.2	Condensed phases	183
7.7	Standard States of Pure Substances	183
7.8	Chemical Potential and Fugacity	184
7.8.1	Gases	185
7.8.2	Liquids and solids	188
7.9	Standard Molar Quantities of a Gas	188
	Problems	191
8	Phase Transitions and Equilibria of Pure Substances	195
8.1	Phase Equilibria	195
8.1.1	Equilibrium conditions	195
8.1.2	Equilibrium in a multiphase system	196
8.1.3	Simple derivation of equilibrium conditions	197
8.1.4	Tall column of gas in a gravitational field	197
8.1.5	The pressure in a liquid droplet	200
8.1.6	The number of independent variables	201
8.1.7	The Gibbs phase rule for a pure substance	202
8.2	Phase Diagrams of Pure Substances	202
8.2.1	Features of phase diagrams	202
8.2.2	Two-phase equilibrium	205
8.2.3	The critical point	207
8.2.4	The lever rule	209
8.2.5	Volume properties	211
8.3	Phase Transitions	213
8.3.1	Molar transition quantities	213
8.3.2	Calorimetric measurement of transition enthalpies	215
8.3.3	Standard molar transition quantities	215
8.4	Coexistence Curves	216

8.4.1	Chemical potential surfaces	216
8.4.2	The Clapeyron equation	217
8.4.3	The Clausius–Clapeyron equation	220
	Problems	223
9	Mixtures	225
9.1	Composition Variables	225
9.1.1	Species and substances	225
9.1.2	Mixtures in general	225
9.1.3	Solutions	226
9.1.4	Binary solutions	226
9.1.5	The composition of a mixture	228
9.2	Partial Molar Quantities	228
9.2.1	Partial molar volume	229
9.2.2	The total differential of the volume in an open system	230
9.2.3	Evaluation of partial molar volumes in binary mixtures	232
9.2.4	General relations	235
9.2.5	Partial specific quantities	237
9.2.6	The chemical potential of a species in a mixture	237
9.2.7	Equilibrium conditions in a multiphase, multicomponent system	238
9.2.8	Relations involving partial molar quantities	239
9.3	Gas Mixtures	241
9.3.1	Partial pressure	241
9.3.2	The ideal gas mixture	241
9.3.3	Partial molar quantities in an ideal gas mixture	242
9.3.4	Real gas mixtures	244
9.4	Liquid and Solid Mixtures of Nonelectrolytes	247
9.4.1	Raoult’s law	248
9.4.2	Ideal mixtures	249
9.4.3	Partial molar quantities in ideal mixtures	250
9.4.4	Henry’s law	251
9.4.5	The ideal-dilute solution	254
9.4.6	Solvent behavior in the ideal-dilute solution	256
9.4.7	Partial molar quantities in an ideal-dilute solution	258
9.5	Activity Coefficients in Mixtures of Nonelectrolytes	259
9.5.1	Reference states and standard states	259
9.5.2	Ideal mixtures	259
9.5.3	Real mixtures	261
9.5.4	Nonideal dilute solutions	262
9.6	Evaluation of Activity Coefficients	263
9.6.1	Activity coefficients from gas fugacities	264
9.6.2	Activity coefficients from the Gibbs–Duhem equation	267
9.6.3	Activity coefficients from osmotic coefficients	268
9.6.4	Fugacity measurements	269
9.7	Activity of an Uncharged Species	271
9.7.1	Standard states	271
9.7.2	Activities and composition	273

9.7.3	Pressure factors and pressure	274
9.8	Mixtures in Gravitational and Centrifugal Fields	276
9.8.1	Gas mixture in a gravitational field	276
9.8.2	Liquid solution in a centrifuge cell	278
	Problems	282
10	Electrolyte Solutions	287
10.1	Single-ion Quantities	288
10.2	Solution of a Symmetrical Electrolyte	290
10.3	Electrolytes in General	292
10.3.1	Solution of a single electrolyte	293
10.3.2	Multisolute solution	294
10.3.3	Incomplete dissociation	295
10.4	The Debye–Hückel Theory	295
10.5	Derivation of the Debye–Hückel Equation	299
10.6	Mean Ionic Activity Coefficients from Osmotic Coefficients	301
	Problems	303
11	Reactions and Other Chemical Processes	304
11.1	Mixing Processes	304
11.1.1	Mixtures in general	305
11.1.2	Ideal mixtures	305
11.1.3	Excess quantities	307
11.1.4	The entropy change to form an ideal gas mixture	308
11.1.5	Molecular model of a liquid mixture	310
11.1.6	Phase separation of a liquid mixture	312
11.2	The Advancement and Molar Reaction Quantities	314
11.2.1	An example: ammonia synthesis	315
11.2.2	Molar reaction quantities in general	317
11.2.3	Standard molar reaction quantities	319
11.3	Molar Reaction Enthalpy	320
11.3.1	Molar reaction enthalpy and heat	320
11.3.2	Standard molar enthalpies of reaction and formation	320
11.3.3	Molar reaction heat capacity	324
11.3.4	Effect of temperature on reaction enthalpy	324
11.4	Enthalpies of Solution and Dilution	325
11.4.1	Molar enthalpy of solution	326
11.4.2	Enthalpy of dilution	328
11.4.3	Molar enthalpies of solute formation	329
11.4.4	Evaluation of relative partial molar enthalpies	330
11.5	Reaction Calorimetry	334
11.5.1	The constant-pressure reaction calorimeter	334
11.5.2	The bomb calorimeter	336
11.5.3	Other calorimeters	342
11.6	Adiabatic Flame Temperature	342
11.7	Gibbs Energy and Reaction Equilibrium	343
11.7.1	The molar reaction Gibbs energy	343

11.7.2	Spontaneity and reaction equilibrium	343
11.7.3	General derivation	344
11.7.4	Pure phases	345
11.7.5	Reactions involving mixtures	346
11.7.6	Reaction in an ideal gas mixture	347
11.8	The Thermodynamic Equilibrium Constant	350
11.8.1	Activities and the definition of K	350
11.8.2	Reaction in a gas phase	353
11.8.3	Reaction in solution	354
11.8.4	Evaluation of K	355
11.9	Effects of Temperature and Pressure on Equilibrium Position	357
	Problems	360
12	Equilibrium Conditions in Multicomponent Systems	367
12.1	Effects of Temperature	367
12.1.1	Variation of μ_i/T with temperature	367
12.1.2	Variation of μ_i°/T with temperature	368
12.1.3	Variation of $\ln K$ with temperature	369
12.2	Solvent Chemical Potentials from Phase Equilibria	370
12.2.1	Freezing-point measurements	371
12.2.2	Osmotic-pressure measurements	373
12.3	Binary Mixture in Equilibrium with a Pure Phase	375
12.4	Colligative Properties of a Dilute Solution	376
12.4.1	Freezing-point depression	377
12.4.2	Boiling-point elevation	379
12.4.3	Vapor-pressure lowering	381
12.4.4	Osmotic pressure	381
12.5	Solid–Liquid Equilibria	382
12.5.1	Freezing points of ideal binary liquid mixtures	382
12.5.2	Solubility of a solid nonelectrolyte	385
12.5.3	Ideal solubility of a solid	386
12.5.4	Solid compound of mixture components	387
12.5.5	Solubility of a solid electrolyte	389
12.6	Liquid–Liquid Equilibria	391
12.6.1	Miscibility in binary liquid systems	391
12.6.2	Solubility of one liquid in another	392
12.6.3	Solute distribution between two partially-miscible solvents	394
12.7	Membrane Equilibria	395
12.7.1	Osmotic membrane equilibrium	395
12.7.2	Equilibrium dialysis	396
12.7.3	Donnan membrane equilibrium	396
12.8	Liquid–Gas Equilibria	399
12.8.1	Effect of liquid pressure on gas fugacity	399
12.8.2	Effect of liquid composition on gas fugacities	401
12.8.3	The Duhem–Margules equation	404
12.8.4	Gas solubility	405
12.8.5	Effect of temperature and pressure on Henry’s law constants	407

12.9	Reaction Equilibria	408
12.10	Evaluation of Standard Molar Quantities	410
	Problems	412
13	The Phase Rule and Phase Diagrams	418
13.1	The Gibbs Phase Rule for Multicomponent Systems	418
13.1.1	Degrees of freedom	419
13.1.2	Species approach to the phase rule	419
13.1.3	Components approach to the phase rule	421
13.1.4	Examples	422
13.2	Phase Diagrams: Binary Systems	425
13.2.1	Generalities	425
13.2.2	Solid–liquid systems	426
13.2.3	Partially-miscible liquids	429
13.2.4	Liquid–gas systems with ideal liquid mixtures	431
13.2.5	Liquid–gas systems with nonideal liquid mixtures	434
13.2.6	Solid–gas systems	436
13.2.7	Systems at high pressure	438
13.3	Phase Diagrams: Ternary Systems	440
13.3.1	Three liquids	441
13.3.2	Two solids and a solvent	443
	Problems	445
14	Galvanic Cells	449
14.1	Cell Diagrams and Cell Reactions	449
14.1.1	Elements of a galvanic cell	449
14.1.2	Cell diagrams	450
14.1.3	Electrode reactions and the cell reaction	451
14.1.4	Advancement and charge	451
14.2	Electric Potentials in the Cell	452
14.2.1	Cell potential	452
14.2.2	Measuring the equilibrium cell potential	454
14.2.3	Interfacial potential differences	454
14.3	Molar Reaction Quantities of the Cell Reaction	457
14.3.1	Relation between $\Delta_r G_{\text{cell}}$ and $E_{\text{cell, eq}}$	457
14.3.2	Relation between $\Delta_r G_{\text{cell}}$ and $\Delta_r G$	459
14.3.3	Standard molar reaction quantities	460
14.4	The Nernst Equation	462
14.5	Evaluation of the Standard Cell Potential	463
14.6	Standard Electrode Potentials	464
	Problems	467
	Appendix A Definitions of the SI Base Units	470
	Appendix B Physical Constants	472
	Appendix C Symbols for Physical Quantities	473

Appendix D Miscellaneous Abbreviations and Symbols	477
D.1 Physical States	477
D.2 Subscripts for Chemical Processes	478
D.3 Superscripts	479
Appendix E Calculus Review	480
E.1 Derivatives	480
E.2 Partial Derivatives	480
E.3 Integrals	481
E.4 Line Integrals	481
Appendix F Mathematical Properties of State Functions	482
F.1 Differentials	482
F.2 Total Differential	482
F.3 Integration of a Total Differential	484
F.4 Legendre Transforms	485
Appendix G Forces, Energy, and Work	487
G.1 Forces between Particles	488
G.2 The System and Surroundings	491
G.3 System Energy Change	493
G.4 Macroscopic Work	494
G.5 The Work Done on the System and Surroundings	495
G.6 The Local Frame and Internal Energy	496
G.7 Nonrotating Local Frame	499
G.8 Center-of-mass Local Frame	500
G.9 Rotating Local Frame	502
G.10 Earth-Fixed Reference Frame	503
Appendix H Standard Molar Thermodynamic Properties	505
Appendix I Answers to Selected Problems	508
Bibliography	512
Index	521

BIOGRAPHICAL SKETCHES

Benjamin Thompson, Count of Rumford	64
James Prescott Joule	88
Sadi Carnot	110
Rudolf Julius Emmanuel Clausius	113
William Thomson, Lord Kelvin	118
Max Karl Ernst Ludwig Planck	120
Josiah Willard Gibbs	142
Walther Hermann Nernst	154
William Francis Giauque	163
Benoit Paul Émile Clapeyron	219
William Henry	252
Gilbert Newton Lewis	272
Peter Josephus Wilhelmus Debye	296
Germain Henri Hess	323
François-Marie Raoult	380
Jacobus Henricus van't Hoff	383

PREFACE TO THE SECOND EDITION

This second edition of *Thermodynamics and Chemistry* is a revised and enlarged version of the first edition published by Prentice Hall in 2001. The book is designed primarily as a textbook for a one-semester course for graduate or undergraduate students who have already been introduced to thermodynamics in a physical chemistry course.

The PDF file of this book contains hyperlinks to pages, sections, equations, tables, figures, bibliography items, and problems. If you are viewing the PDF on a computer screen, tablet, or color e-reader, the links are colored in blue.

Scattered through the text are sixteen one-page biographical sketches of some of the historical giants of thermodynamics. A list is given on the preceding page. The sketches are not intended to be comprehensive biographies, but rather to illustrate the human side of thermodynamics—the struggles and controversies by which the concepts and experimental methodology of the subject were developed.

The epigraphs on page 18 are intended to suggest the nature and importance of classical thermodynamics. You may wonder about the conversation between Alice and Humpty Dumpty. Its point, particularly important in the study of thermodynamics, is the need to pay attention to definitions—the intended meanings of words.

I welcome comments and suggestions for improving this book. My e-mail address appears below.

Howard DeVoe
hdevoe@umd.edu

FROM THE PREFACE TO THE FIRST EDITION

Classical thermodynamics, the subject of this book, is concerned with macroscopic aspects of the interaction of matter with energy in its various forms. This book is designed as a text for a one-semester course for senior undergraduate or graduate students who have already been introduced to thermodynamics in an undergraduate physical chemistry course.

Anyone who studies and uses thermodynamics knows that a deep understanding of this subject does not come easily. There are subtleties and interconnections that are difficult to grasp at first. The more times one goes through a thermodynamics course (as a student or a teacher), the more insight one gains. Thus, this text will reinforce and extend the knowledge gained from an earlier exposure to thermodynamics. To this end, there is fairly intense discussion of some basic topics, such as the nature of spontaneous and reversible processes, and inclusion of a number of advanced topics, such as the reduction of bomb calorimetry measurements to standard-state conditions.

This book makes no claim to be an exhaustive treatment of thermodynamics. It concentrates on derivations of fundamental relations starting with the thermodynamic laws and on applications of these relations in various areas of interest to chemists. Although classical thermodynamics treats matter from a purely macroscopic viewpoint, the book discusses connections with molecular properties when appropriate.

In deriving equations, I have strived for rigor, clarity, and a minimum of mathematical complexity. I have attempted to clearly state the conditions under which each theoretical relation is valid because only by understanding the assumptions and limitations of a derivation can one know when to use the relation and how to adapt it for special purposes. I have taken care to be consistent in the use of symbols for physical properties. The choice of symbols follows the current recommendations of the International Union of Pure and Applied Chemistry (IUPAC) with a few exceptions made to avoid ambiguity.

I owe much to J. Arthur Campbell, Luke E. Steiner, and William Moffitt, gifted teachers who introduced me to the elegant logic and practical utility of thermodynamics. I am immensely grateful to my wife Stephanie for her continued encouragement and patience during the period this book went from concept to reality.

I would also like to acknowledge the help of the following reviewers: James L. Copeland, Kansas State University; Lee Hansen, Brigham Young University; Reed Howald, Montana State University–Bozeman; David W. Larsen, University of Missouri–St. Louis; Mark Ondrias, University of New Mexico; Philip H. Rieger, Brown University; Leslie Schwartz, St. John Fisher College; Allan L. Smith, Drexel University; and Paul E. Smith, Kansas State University.

A theory is the more impressive the greater the simplicity of its premises is, the more different kinds of things it relates, and the more extended is its area of applicability. Therefore the deep impression which classical thermodynamics made upon me. It is the only physical theory of universal content concerning which I am convinced that, within the framework of the applicability of its basic concepts, it will never be overthrown.

Albert Einstein

Thermodynamics is a discipline that involves a formalization of a large number of intuitive concepts derived from common experience.

J. G. Kirkwood and I. Oppenheim, *Chemical Thermodynamics*, 1961

The first law of thermodynamics is nothing more than the principle of the conservation of energy applied to phenomena involving the production or absorption of heat.

Max Planck, *Treatise on Thermodynamics*, 1922

The law that entropy always increases—the second law of thermodynamics—holds, I think, the supreme position among the laws of Nature. If someone points out to you that your pet theory of the universe is in disagreement with Maxwell's equations—then so much the worse for Maxwell's equations. If it is found to be contradicted by observation—well, these experimentalists do bungle things sometimes. But if your theory is found to be against the second law of thermodynamics I can give you no hope; there is nothing for it but to collapse in deepest humiliation.

Sir Arthur Eddington, *The Nature of the Physical World*, 1928

Thermodynamics is a collection of useful relations between quantities, every one of which is independently measurable. What do such relations “tell one” about one's system, or in other words what do we learn from thermodynamics about the microscopic explanations of macroscopic changes? Nothing whatever. What then is the *use* of thermodynamics? Thermodynamics is useful precisely because some quantities are easier to measure than others, and that is all.

M. L. McGlashan, *J. Chem. Educ.*, **43**, 226–232 (1966)

“When *I* use a word,” Humpty Dumpty said, in rather a scornful tone, “it means just what I choose it to mean—neither more nor less.”

“The question is,” said Alice, “whether you *can* make words mean so many different things.”

“The question is,” said Humpty Dumpty, “which is to be master—that's all.”

Lewis Carroll, *Through the Looking-Glass*

CHAPTER 1

INTRODUCTION

Thermodynamics is a quantitative subject. It allows us to derive relations between the values of numerous physical quantities. Some physical quantities, such as mole fraction, are dimensionless; the value of one of these quantities is a pure number. Most quantities, however, are not dimensionless and their values must include one or more *units*. This chapter describes the SI system of units, which are the preferred units in science applications. The chapter then discusses some useful mathematical manipulations of physical quantities using quantity calculus, and certain general aspects of dimensional analysis.

1.1 Physical Quantities, Units, and Symbols

1.1.1 The International System of Units

There is international agreement that the units used for physical quantities in science and technology should be those of the International System of Units, or SI (standing for the French **Système International d'Unités**).

Physical quantities and units are denoted by symbols. This book will, with a few exceptions, use symbols recommended in the third edition of what is known, from the color of its cover, as the IUPAC Green Book.¹ This publication is a manual of recommended symbols and terminology based on the SI and produced by the International Union of Pure and Applied Chemistry (IUPAC). The symbols for physical quantities are listed for convenient reference in Appendices C and D.

The SI includes the seven **base units** listed in Table 1.1 on the next page. These base units are for seven independent physical quantities that are sufficient to describe all other physical quantities. Definitions of the base units are given in Appendix A. (The candela, the SI unit of luminous intensity, is usually not needed in thermodynamics and is not used in this book.)

1.1.2 Amount of substance and amount

The physical quantity formally called **amount of substance** is a counting quantity for specified elementary entities. An elementary entity may be an atom, a molecule, an ion, an electron, any other particle or specified group of particles. The SI base unit for amount of substance is the **mole**.

¹Ref. [36]. The references are listed in the Bibliography at the back of the book.

Table 1.1 SI base units

Physical quantity	SI unit	Symbol
time	second	s
length	meter ^a	m
mass	kilogram	kg
thermodynamic temperature	kelvin	K
amount of substance	mole	mol
electric current	ampere	A
luminous intensity	candela	cd

^aor metre

Before 2019, the mole was defined as the amount of substance containing as many elementary entities as the number of atoms in exactly 12 grams of pure carbon-12 nuclide, ¹²C. This definition was such that one mole of H₂O molecules, for example, has a mass of 18.02 grams, where 18.02 is the relative molecular mass of H₂O, and contains 6.022×10^{23} molecules, where $6.022 \times 10^{23} \text{ mol}^{-1}$ is N_A , the *Avogadro constant* (values given to four significant digits). The same statement can be made for any other substance if 18.02 is replaced by the appropriate relative atomic mass or molecular mass value (Sec. 2.3.2).

The SI revision of 2019 (Sec. 1.1.3) redefines the mole as exactly $6.022,140,76 \times 10^{23}$ elementary entities. The mass of this number of carbon-12 atoms is 12 grams to within 5×10^{-9} gram,² so the revision makes a negligible change to calculations involving the mole.

The symbol for amount of substance is n . It is admittedly awkward to refer to $n(\text{H}_2\text{O})$ as “the amount of substance of water.” This book simply shortens “amount of substance” to **amount**, a usage condoned by the IUPAC.³ Thus, “the amount of water in the system” refers not to the mass or volume of water, but to the *number* of H₂O molecules expressed in a counting unit such as the mole.

1.1.3 The SI revision of 2019

At a General Conference on Weights and Measures held in Versailles, France in November 2018, metrologists from over fifty countries agreed on a major revision of the International System of Units. The revision became official on 20 May 2019. It redefines the base units for mass, thermodynamic temperature, amount of substance, and electric current.

The SI revision bases the definitions of the base units (Appendix A) on a set of six defining constants with values (listed in Appendix B) treated as exact, with no uncertainty.

Previously, the kilogram had been defined as the mass of a physical artifact, the international prototype of the kilogram. The international prototype is a platinum-iridium cylinder manufactured in 1879 in England and stored since 1889 in a vault of the International Bureau of Weights and Measures in Sèvres, near Paris, France. As it is subject to surface contamination and other slow changes of mass, it is not entirely suitable as a standard.

The 2019 SI revision instead defines the kilogram in terms of the Planck constant h .⁴ As a defining constant, the value of h was chosen to agree with the mass of the international

²Ref. [165], Appendix 2. ³Ref. [125]. An alternative name suggested for n is “chemical amount.” ⁴The manner in which this is done using a Kibble balance is described on page 37.

Table 1.2 SI derived units

Physical quantity	Unit	Symbol	Definition of unit
force	newton	N	$1 \text{ N} = 1 \text{ m kg s}^{-2}$
pressure	pascal	Pa	$1 \text{ Pa} = 1 \text{ N m}^{-2} = 1 \text{ kg m}^{-1} \text{ s}^{-2}$
Celsius temperature	degree Celsius	$^{\circ}\text{C}$	$t/^{\circ}\text{C} = T/\text{K} - 273.15$
energy	joule	J	$1 \text{ J} = 1 \text{ N m} = 1 \text{ m}^2 \text{ kg s}^{-2}$
power	watt	W	$1 \text{ W} = 1 \text{ J s}^{-1} = 1 \text{ m}^2 \text{ kg s}^{-3}$
frequency	hertz	Hz	$1 \text{ Hz} = 1 \text{ s}^{-1}$
electric charge	coulomb	C	$1 \text{ C} = 1 \text{ A s}$
electric potential	volt	V	$1 \text{ V} = 1 \text{ J C}^{-1} = 1 \text{ m}^2 \text{ kg s}^{-3} \text{ A}^{-1}$
electric resistance	ohm	Ω	$1 \Omega = 1 \text{ V A}^{-1} = 1 \text{ m}^2 \text{ kg s}^{-3} \text{ A}^{-2}$

Table 1.3 Non-SI derived units

Physical quantity	Unit	Symbol	Definition of unit
volume	liter ^a	L ^b	$1 \text{ L} = 1 \text{ dm}^3 = 10^{-3} \text{ m}^3$
pressure	bar	bar	$1 \text{ bar} = 10^5 \text{ Pa}$
pressure	atmosphere	atm	$1 \text{ atm} = 101,325 \text{ Pa} = 1.01325 \text{ bar}$
pressure	torr	Torr	$1 \text{ Torr} = (1/760) \text{ atm} = (101,325/760) \text{ Pa}$
energy	calorie ^c	cal ^d	$1 \text{ cal} = 4.184 \text{ J}$

^aor litre ^bor l ^cor thermochemical calorie ^dor cal_{th}

prototype with an uncertainty of only several parts in 10^8 . Thus, as a practical matter, the SI revision has a negligible effect on the value of a mass.

The SI revision defines the kelvin in terms of the Boltzmann constant k , the mole in terms of the Avogadro constant N_A , and the ampere in terms of the elementary charge e . The values of these defining constants were chosen to closely agree with the previous base unit definitions. Consequently, the SI revision has a negligible effect on values of thermodynamic temperature, amount of substance, and electric current.

1.1.4 Derived units and prefixes

Table 1.2 lists derived units for some additional physical quantities used in thermodynamics. The derived units have exact definitions in terms of SI base units, as given in the last column of the table.

The units listed in Table 1.3 are sometimes used in thermodynamics but are not part of the SI. They do, however, have exact definitions in terms of SI units and so offer no problems of numerical conversion to or from SI units.

Any of the symbols for units listed in Tables 1.1–1.3, except kg and $^{\circ}\text{C}$, may be preceded by one of the prefix symbols of Table 1.4 on the next page to construct a decimal fraction or multiple of the unit. (The symbol g may be preceded by a prefix symbol to construct a fraction or multiple of the gram.) The combination of prefix symbol and unit symbol is taken as a new symbol that can be raised to a power without using parentheses, as in the following examples:

Table 1.4 SI prefixes

Fraction	Prefix	Symbol	Multiple	Prefix	Symbol
10^{-1}	deci	d	10	deka	da
10^{-2}	centi	c	10^2	hecto	h
10^{-3}	milli	m	10^3	kilo	k
10^{-6}	micro	μ	10^6	mega	M
10^{-9}	nano	n	10^9	giga	G
10^{-12}	pico	p	10^{12}	tera	T
10^{-15}	femto	f	10^{15}	peta	P
10^{-18}	atto	a	10^{18}	exa	E
10^{-21}	zepto	z	10^{21}	zetta	Z
10^{-24}	yocto	y	10^{24}	yotta	Y

$$1 \text{ mg} = 1 \times 10^{-3} \text{ g}$$

$$1 \text{ cm} = 1 \times 10^{-2} \text{ m}$$

$$1 \text{ cm}^3 = (1 \times 10^{-2} \text{ m})^3 = 1 \times 10^{-6} \text{ m}^3$$

1.2 Quantity Calculus

This section gives examples of how we may manipulate physical quantities by the rules of algebra. The method is called *quantity calculus*, although a better term might be “quantity algebra.”

Quantity calculus is based on the concept that a physical quantity, unless it is dimensionless, has a value equal to the product of a *numerical value* (a pure number) and one or more *units*:

$$\text{physical quantity} = \text{numerical value} \times \text{units} \quad (1.2.1)$$

(If the quantity is dimensionless, it is equal to a pure number without units.) The physical property may be denoted by a symbol, but the symbol does *not* imply a particular choice of units. For instance, this book uses the symbol ρ for density, but ρ can be expressed in any units having the dimensions of mass divided by volume.

A simple example illustrates the use of quantity calculus. We may express the density of water at 25 °C to four significant digits in SI base units by the equation

$$\rho = 9.970 \times 10^2 \text{ kg m}^{-3} \quad (1.2.2)$$

and in different density units by the equation

$$\rho = 0.9970 \text{ g cm}^{-3} \quad (1.2.3)$$

We may divide both sides of the last equation by 1 g cm^{-3} to obtain a new equation

$$\rho / \text{g cm}^{-3} = 0.9970 \quad (1.2.4)$$

Now the pure number 0.9970 appearing in this equation is the number of grams in one cubic centimeter of water, so we may call the ratio $\rho / \text{g cm}^{-3}$ “the number of grams per cubic centimeter.” By the same reasoning, $\rho / \text{kg m}^{-3}$ is the number of kilograms per cubic meter. In general, a physical quantity divided by particular units for the physical quantity is a pure number representing the number of those units.

Just as it would be incorrect to call ρ “the number of grams per cubic centimeter,” because that would refer to a particular choice of units for ρ , the common practice of calling n “the number of moles” is also strictly speaking not correct. It is actually the ratio n/mol that is the number of moles.

In a table, the ratio $\rho/\text{g cm}^{-3}$ makes a convenient heading for a column of density values because the column can then show pure numbers. Likewise, it is convenient to use $\rho/\text{g cm}^{-3}$ as the label of a graph axis and to show pure numbers at the grid marks of the axis. You will see many examples of this usage in the tables and figures of this book.

A major advantage of using SI base units and SI derived units is that they are *coherent*. That is, values of a physical quantity expressed in different combinations of these units have the same numerical value.

For example, suppose we wish to evaluate the pressure of a gas according to the ideal gas equation⁵

$$p = \frac{nRT}{V} \quad (1.2.5)$$

(ideal gas)

In this equation, p , n , T , and V are the symbols for the physical quantities pressure, amount (amount of substance), thermodynamic temperature, and volume, respectively, and R is the gas constant.

The calculation of p for 5.000 moles of an ideal gas at a temperature of 298.15 kelvins, in a volume of 4.000 cubic meters, is

$$p = \frac{(5.000 \text{ mol})(8.3145 \text{ J K}^{-1} \text{ mol}^{-1})(298.15 \text{ K})}{4.000 \text{ m}^3} = 3.099 \times 10^3 \text{ J m}^{-3} \quad (1.2.6)$$

The mole and kelvin units cancel, and we are left with units of J m^{-3} , a combination of an SI derived unit (the joule) and an SI base unit (the meter). The units J m^{-3} must have dimensions of pressure, but are not commonly used to express pressure.

To convert J m^{-3} to the SI derived unit of pressure, the pascal (Pa), we can use the following relations from Table 1.2:

$$1 \text{ J} = 1 \text{ N m} \quad 1 \text{ Pa} = 1 \text{ N m}^{-2} \quad (1.2.7)$$

When we divide both sides of the first relation by 1 J and divide both sides of the second relation by 1 N m^{-2} , we obtain the two new relations

$$1 = (1 \text{ N m}/\text{J}) \quad (1 \text{ Pa}/\text{N m}^{-2}) = 1 \quad (1.2.8)$$

The ratios in parentheses are *conversion factors*. When a physical quantity is multiplied by a conversion factor that, like these, is equal to the pure number 1, the physical quantity changes its units but not its value. When we multiply Eq. 1.2.6 by both of these conversion factors, all units cancel except Pa:

$$\begin{aligned} p &= (3.099 \times 10^3 \text{ J m}^{-3}) \times (1 \text{ N m}/\text{J}) \times (1 \text{ Pa}/\text{N m}^{-2}) \\ &= 3.099 \times 10^3 \text{ Pa} \end{aligned} \quad (1.2.9)$$

⁵This is the first equation in this book that, like many others to follow, shows *conditions of validity* in parentheses immediately below the equation number at the right. Thus, Eq. 1.2.5 is valid for an ideal gas.

This example illustrates the fact that to calculate a physical quantity, we can simply enter into a calculator numerical values expressed in SI units, and the result is the numerical value of the calculated quantity expressed in SI units. In other words, as long as we use only SI base units and SI derived units (without prefixes), *all conversion factors are unity*.

Of course we do not have to limit the calculation to SI units. Suppose we wish to express the calculated pressure in torrs, a non-SI unit. In this case, using a conversion factor obtained from the definition of the torr in Table 1.3, the calculation becomes

$$\begin{aligned} p &= (3.099 \times 10^3 \text{ Pa}) \times (760 \text{ Torr}/101,325 \text{ Pa}) \\ &= 23.24 \text{ Torr} \end{aligned} \tag{1.2.10}$$

1.3 Dimensional Analysis

Sometimes you can catch an error in the form of an equation or expression, or in the dimensions of a quantity used for a calculation, by checking for dimensional consistency. Here are some rules that must be satisfied:

- both sides of an equation have the same dimensions
- all terms of a sum or difference have the same dimensions
- logarithms and exponentials, and arguments of logarithms and exponentials, are dimensionless
- a quantity used as a power is dimensionless

In this book the *differential* of a function, such as df , refers to an *infinitesimal* quantity. If one side of an equation is an infinitesimal quantity, the other side must also be. Thus, the equation $df = a dx + b dy$ (where ax and by have the same dimensions as f) makes mathematical sense, but $df = ax + b dy$ does not.

Derivatives, partial derivatives, and integrals have dimensions that we must take into account when determining the overall dimensions of an expression that includes them. For instance:

- the derivative dp/dT and the partial derivative $(\partial p/\partial T)_V$ have the same dimensions as p/T
- the partial second derivative $(\partial^2 p/\partial T^2)_V$ has the same dimensions as p/T^2
- the integral $\int T dT$ has the same dimensions as T^2

Some examples of applying these principles are given here using symbols described in Sec. 1.2.

Example 1. Since the gas constant R may be expressed in units of $\text{J K}^{-1} \text{ mol}^{-1}$, it has dimensions of energy divided by thermodynamic temperature and amount. Thus, RT has dimensions of energy divided by amount, and nRT has dimensions of energy. The products RT and nRT appear frequently in thermodynamic expressions.

Example 2. What are the dimensions of the quantity $nRT \ln(p/p^\circ)$ and of p° in this expression? The quantity has the same dimensions as nRT (or energy) because the logarithm is dimensionless. Furthermore, p° in this expression has dimensions of pressure in order to make the argument of the logarithm, p/p° , dimensionless.

Example 3. Find the dimensions of the constants a and b in the van der Waals equation

$$p = \frac{nRT}{V - nb} - \frac{n^2a}{V^2}$$

Dimensional analysis tells us that, because nb is subtracted from V , nb has dimensions of volume and therefore b has dimensions of volume/amount. Furthermore, since the right side of the equation is a difference of two terms, these terms have the same dimensions as the left side, which is pressure. Therefore, the second term n^2a/V^2 has dimensions of pressure, and a has dimensions of pressure \times volume² \times amount⁻².

Example 4. Consider an equation of the form

$$\left(\frac{\partial \ln x}{\partial T}\right)_p = \frac{y}{R}$$

What are the SI units of y ? $\ln x$ is dimensionless, so the left side of the equation has the dimensions of $1/T$, and its SI units are K^{-1} . The SI units of the right side are therefore also K^{-1} . Since R has the units $\text{J K}^{-1} \text{mol}^{-1}$, the SI units of y are $\text{J K}^{-2} \text{mol}^{-1}$.

PROBLEM

1.1 Consider the following equations for the pressure of a real gas. For each equation, find the dimensions of the constants a and b and express these dimensions in SI units.

(a) The Dieterici equation:

$$p = \frac{RTe^{-(an/VRT)}}{(V/n) - b}$$

(b) The Redlich–Kwong equation:

$$p = \frac{RT}{(V/n) - b} - \frac{an^2}{T^{1/2}V(V + nb)}$$

CHAPTER 2

SYSTEMS AND THEIR PROPERTIES

This chapter begins by explaining some basic terminology of thermodynamics. It discusses macroscopic properties of matter in general and properties distinguishing different physical states of matter in particular. Virial equations of state of a pure gas are introduced. The chapter goes on to discuss some basic macroscopic properties and their measurement. Finally, several important concepts needed in later chapters are described: thermodynamic states and state functions, independent and dependent variables, processes, and internal energy.

2.1 The System, Surroundings, and Boundary

Chemists are interested in systems containing matter—that which has mass and occupies physical space. Classical thermodynamics looks at *macroscopic* aspects of matter. It deals with the properties of aggregates of vast numbers of microscopic particles (molecules, atoms, and ions). The macroscopic viewpoint, in fact, treats matter as a *continuous* material medium rather than as the collection of discrete microscopic particles we know are actually present. Although this book is an exposition of classical thermodynamics, at times it will point out connections between macroscopic properties and molecular structure and behavior.

A thermodynamic **system** is any three-dimensional region of physical space on which we wish to focus our attention. Usually we consider only one system at a time and call it simply “the system.” The rest of the physical universe constitutes the **surroundings** of the system.

The **boundary** is the closed three-dimensional surface that encloses the system and separates it from the surroundings. The boundary may (and usually does) coincide with real physical surfaces: the interface between two phases, the inner or outer surface of the wall of a flask or other vessel, and so on. Alternatively, part or all of the boundary may be an imagined intangible surface in space, unrelated to any physical structure. The size and shape of the system, as defined by its boundary, may change in time. In short, our choice of the three-dimensional region that constitutes the system is arbitrary—but it is essential that we know exactly what this choice is.

We usually think of the system as a part of the physical universe that we are able to influence only indirectly through its interaction with the surroundings, and the surroundings as the part of the universe that we are able to directly manipulate with various physical

devices under our control. That is, we (the experimenters) are part of the surroundings, not the system.

For some purposes we may wish to treat the system as being divided into *subsystems*, or to treat the combination of two or more systems as a *supersystem*.

If over the course of time matter is transferred in either direction across the boundary, the system is **open**; otherwise it is **closed**. If the system is open, matter may pass through a stationary boundary, or the boundary may move through matter that is fixed in space.

If the boundary allows heat transfer between the system and surroundings, the boundary is **diathermal**. An **adiabatic**¹ boundary, on the other hand, is a boundary that does not allow heat transfer. We can, in principle, ensure that the boundary is adiabatic by surrounding the system with an adiabatic wall—one with perfect thermal insulation and a perfect radiation shield.

An **isolated** system is one that exchanges no matter, heat, or work with the surroundings, so that the system's mass and total energy remain constant over time.² A closed system with an adiabatic boundary, constrained to do no work and to have no work done on it, is an isolated system.

The constraints required to prevent work usually involve forces between the system and surroundings. In that sense a system may interact with the surroundings even though it is isolated. For instance, a gas contained within rigid, thermally-insulated walls is an isolated system; the gas exerts a force on each wall, and the wall exerts an equal and opposite force on the gas. An isolated system may also experience a constant external field, such as a gravitational field.

The term **body** usually implies a system, or part of a system, whose mass and chemical composition are constant over time.

2.1.1 Extensive and intensive properties

A quantitative *property* of a system describes some macroscopic feature that, although it may vary with time, has a particular value at any given instant of time.

Table 2.1 on the next page lists the symbols of some of the properties discussed in this chapter and the SI units in which they may be expressed. A much more complete table is found in Appendix C.

Most of the properties studied by thermodynamics may be classified as either *extensive* or *intensive*. We can distinguish these two types of properties by the following considerations.

If we imagine the system to be divided by an imaginary surface into two parts, any property of the system that is the sum of the property for the two parts is an **extensive property**. That is, an additive property is extensive. Examples are mass, volume, amount, energy, and the surface area of a solid.

Sometimes a more restricted definition of an extensive property is used: The property must be not only additive, but also proportional to the mass or the amount when inten-

¹Greek: *impassable*.

²The energy in this definition of an isolated system is measured in a local reference frame, as will be explained in Sec. 2.6.2.

Table 2.1 Symbols and SI units for some common properties

Symbol	Physical quantity	SI unit
E	energy	J
m	mass	kg
n	amount of substance	mol
p	pressure	Pa
T	thermodynamic temperature	K
V	volume	m ³
U	internal energy	J
ρ	density	kg m ⁻³

sive properties remain constant. According to this definition, mass, volume, amount, and energy are extensive, but surface area is not.

If we imagine a homogeneous region of space to be divided into two or more parts of arbitrary size, any property that has the same value in each part and the whole is an **intensive property**; for example density, concentration, pressure (in a fluid), and temperature. The value of an intensive property is the same everywhere in a homogeneous region, but may vary from point to point in a heterogeneous region—it is a *local* property.

Since classical thermodynamics treats matter as a continuous medium, whereas matter actually contains discrete microscopic particles, the value of an intensive property at a point is a statistical average of the behavior of many particles. For instance, the density of a gas at one point in space is the average mass of a small volume element at that point, large enough to contain many molecules, divided by the volume of that element.

Some properties are defined as the ratio of two extensive quantities. If both extensive quantities refer to a homogeneous region of the system or to a small volume element, the ratio is an *intensive* property. For example concentration, defined as the ratio amount/volume, is intensive. A mathematical derivative of one such extensive quantity with respect to another is also intensive.

A special case is an extensive quantity divided by the mass, giving an intensive **specific quantity**; for example

$$\text{Specific volume} = \frac{V}{m} = \frac{1}{\rho} \quad (2.1.1)$$

If the symbol for the extensive quantity is a capital letter, it is customary to use the corresponding lower-case letter as the symbol for the specific quantity. Thus the symbol for specific volume is v .

Another special case encountered frequently in this book is an extensive property for a pure, homogeneous substance divided by the amount n . The resulting intensive property is called, in general, a **molar quantity** or molar property. To symbolize a molar quantity, this book follows the recommendation of the IUPAC: The symbol of the extensive quantity is followed by subscript m, and optionally the identity of the substance is indicated either by a subscript or a formula in parentheses. Examples are

$$\text{Molar volume} = \frac{V}{n} = V_m \quad (2.1.2)$$

$$\text{Molar volume of substance } i = \frac{V}{n_i} = V_{m,i} \quad (2.1.3)$$

$$\text{Molar volume of H}_2\text{O} = V_m(\text{H}_2\text{O}) \quad (2.1.4)$$

In the past, especially in the United States, molar quantities were commonly denoted with an overbar (e.g., \bar{V}_i).

2.2 Phases and Physical States of Matter

A **phase** is a region of the system in which each intensive property (such as temperature and pressure) has at each instant either the same value throughout (a *uniform* or *homogeneous* phase), or else a value that varies continuously from one point to another. Whenever this book mentions a phase, it is a *uniform* phase unless otherwise stated. Two different phases meet at an **interface surface**, where intensive properties have a discontinuity or change value over a small distance.

Some intensive properties (e.g., refractive index and polarizability) can have directional characteristics. A uniform phase may be either *isotropic*, exhibiting the same values of these properties in all directions, or *anisotropic*, as in the case of some solids and liquid crystals. A vacuum is a uniform phase of zero density.

Suppose we have to deal with a *nonuniform* region in which intensive properties vary continuously in space along one or more directions—for example, a tall column of gas in a gravitational field whose density decreases with increasing altitude. There are two ways we may treat such a nonuniform, continuous region: either as a single nonuniform phase, or else as an infinite number of uniform phases, each of infinitesimal size in one or more dimensions.

2.2.1 Physical states of matter

We are used to labeling phases by physical state, or state of aggregation. It is common to say that a phase is a *solid* if it is relatively rigid, a *liquid* if it is easily deformed and relatively incompressible, and a *gas* if it is easily deformed and easily compressed. Since these descriptions of responses to external forces differ only in degree, they are inadequate to classify intermediate cases.

A more rigorous approach is to make a primary distinction between a *solid* and a *fluid*, based on the phase's response to an applied shear stress, and then use additional criteria to classify a fluid as a *liquid*, *gas*, or *supercritical fluid*. **Shear stress** is a tangential force per unit area that is exerted on matter on one side of an interior plane by the matter on the other side. We can produce shear stress in a phase by applying tangential forces to parallel surfaces of the phase as shown in Fig. 2.1 on the next page.

A **solid** responds to shear stress by undergoing momentary relative motion of its parts, resulting in *deformation*—a change of shape. If the applied shear stress is constant and small (not large enough to cause creep or fracture), the solid quickly reaches a certain degree of deformation that depends on the magnitude of the stress and maintains this deformation without further change as long as the shear stress continues to be applied. On the microscopic level, deformation requires relative movement of adjacent layers of particles (atoms, molecules, or ions). The shape of an unstressed solid is determined by

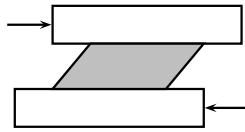

Figure 2.1 Experimental procedure for producing shear stress in a phase (shaded). Blocks at the upper and lower surfaces of the phase are pushed in opposite directions, dragging the adjacent portions of the phase with them.

the attractive and repulsive forces between the particles; these forces make it difficult for adjacent layers to slide past one another, so that the solid resists deformation.

A **fluid** responds to shear stress differently, by undergoing continuous relative motion (flow) of its parts. The flow continues as long as there is any shear stress, no matter how small, and stops only when the shear stress is removed.

Thus, a constant applied shear stress causes a fixed deformation in a solid and continuous flow in a fluid. We say that a phase under constant shear stress is a solid if, after the initial deformation, we are unable to detect a further change in shape during the period we observe the phase.

Usually this criterion allows us to unambiguously classify a phase as either a solid or a fluid. Over a sufficiently long time period, however, detectable flow is likely to occur in *any* material under shear stress of *any* magnitude. Thus, the distinction between solid and fluid actually depends on the time scale of observation. This fact is obvious when we observe the behavior of certain materials (such as Silly Putty, or a paste of water and cornstarch) that exhibit solid-like behavior over a short time period and fluid-like behavior over a longer period. Such materials, that resist deformation by a suddenly-applied shear stress but undergo flow over a longer time period, are called *viscoelastic solids*.

2.2.2 Phase coexistence and phase transitions

This section considers some general characteristics of systems containing more than one phase.

Suppose we bring two uniform phases containing the same constituents into physical contact at an interface surface. If we find that the phases have no tendency to change over time while both have the same temperature and the same pressure, but differ in other intensive properties such as density and composition, we say that they **coexist** in equilibrium with one another. The conditions for such phase coexistence are the subject of later sections in this book, but they tend to be quite restricted. For instance, the liquid and gas phases of pure H_2O at a pressure of 1 bar can coexist at only one temperature, 99.61°C .

A **phase transition** of a pure substance is a change over time in which there is a continuous transfer of the substance from one phase to another. Eventually one phase can completely disappear, and the substance has been completely transferred to the other phase. If both phases coexist in equilibrium with one another, and the temperature and pressure of both phases remain equal and constant during the phase transition, the change is an *equilibrium phase transition*. For example, H_2O at 99.61°C and 1 bar can undergo an equilibrium phase transition from liquid to gas (vaporization) or from gas to liquid (condensation). Dur-

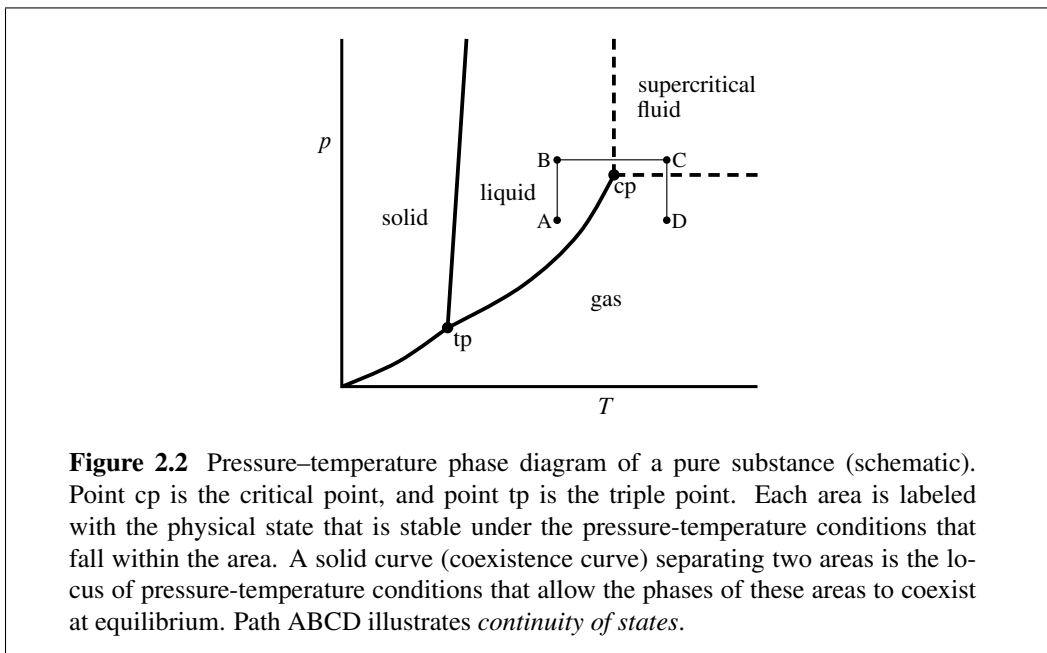

ing an equilibrium phase transition, there is a transfer of energy between the system and its surroundings by means of heat or work.

2.2.3 Fluids

It is usual to classify a fluid as either a *liquid* or a *gas*. The distinction is important for a pure substance because the choice determines the treatment of the phase’s standard state (see Sec. 7.7). To complicate matters, a fluid at high pressure may be a *supercritical fluid*. Sometimes a *plasma* (a highly ionized, electrically conducting medium) is considered a separate kind of fluid state; it is the state found in the earth’s ionosphere and in stars.

In general, and provided the pressure is not high enough for supercritical phenomena to exist—usually true of pressures below 25 bar except in the case of He or H₂—we can make the distinction between liquid and gas simply on the basis of density. A **liquid** has a relatively high density that is insensitive to changes in temperature and pressure. A **gas**, on the other hand, has a relatively low density that is sensitive to temperature and pressure and that approaches zero as pressure is reduced at constant temperature.

This simple distinction between liquids and gases fails at high pressures, where liquid and gas phases may have similar densities at the same temperature. Figure 2.2 shows how we can classify stable fluid states of a pure substance in relation to a liquid–gas coexistence curve and a critical point. If raising the temperature of a fluid at constant pressure causes a phase transition to a second fluid phase, the original fluid was a liquid and the transition occurs at the liquid–gas *coexistence curve*. This curve ends at a **critical point**, at which all intensive properties of the coexisting liquid and gas phases become identical. The fluid state of a pure substance at a temperature greater than the critical temperature and a pressure greater than the critical pressure is called a **supercritical fluid**.

The term **vapor** is sometimes used for a gas that can be condensed to a liquid by increasing the pressure at constant temperature. By this definition, the vapor state of a substance

exists only at temperatures below the critical temperature.

The designation of a supercritical fluid state of a substance is used more for convenience than because of any unique properties compared to a liquid or gas. If we vary the temperature or pressure in such a way that the substance changes from what we call a liquid to what we call a supercritical fluid, we observe only a continuous density change of a single phase, and no phase transition with two coexisting phases. The same is true for a change from a supercritical fluid to a gas. Thus, by making the changes described by the path ABCD shown in Fig. 2.2, we can transform a pure substance from a liquid at a certain pressure to a gas at the same pressure without ever observing an interface between two coexisting phases! This curious phenomenon is called *continuity of states*.

Chapter 6 will take up the discussion of further aspects of the physical states of pure substances.

If we are dealing with a fluid *mixture* (instead of a pure substance) at a high pressure, it may be difficult to classify the phase as either liquid or gas. The complexity of classification at high pressure is illustrated by the *barotropic effect*, observed in some mixtures, in which a small change of temperature or pressure causes what was initially the more dense of two coexisting fluid phases to become the less dense phase. In a gravitational field, the two phases switch positions.

2.2.4 The equation of state of a fluid

Suppose we prepare a uniform fluid phase containing a known amount n_i of each constituent substance i , and adjust the temperature T and pressure p to definite known values. We expect this phase to have a definite, fixed volume V . If we change any one of the properties T , p , or n_i , there is usually a change in V . The value of V is dependent on the other properties and cannot be varied independently of them. Thus, for a given substance or mixture of substances in a uniform fluid phase, V is a unique function of T , p , and $\{n_i\}$, where $\{n_i\}$ stands for the set of amounts of all substances in the phase. We may be able to express this relation in an explicit equation: $V = f(T, p, \{n_i\})$. This equation (or a rearranged form) that gives a relation among V , T , p , and $\{n_i\}$, is the **equation of state** of the fluid.

We may solve the equation of state, implicitly or explicitly, for any one of the quantities V , T , p , and n_i in terms of the other quantities. Thus, of the $3 + s$ quantities (where s is the number of substances), only $2 + s$ are independent.

The *ideal gas equation*, $p = nRT/V$ (Eq. 1.2.5 on page 23), is an equation of state. It is found experimentally that the behavior of any gas in the limit of low pressure, as temperature is held constant, approaches this equation of state. This limiting behavior is also predicted by kinetic-molecular theory.

If the fluid has only one constituent (i.e., is a pure substance rather than a mixture), then at a fixed T and p the volume is proportional to the amount. In this case, the equation of state may be expressed as a relation among T , p , and the molar volume $V_m = V/n$. The equation of state for a pure ideal gas may be written $p = RT/V_m$.

The *Redlich-Kwong equation* is a two-parameter equation of state frequently used to describe, to good accuracy, the behavior of a pure gas at a pressure where the ideal gas equation fails:

$$p = \frac{RT}{V_m - b} - \frac{a}{V_m(V_m + b)T^{1/2}} \quad (2.2.1)$$

In this equation, a and b are constants that are independent of temperature and depend on the substance.

The next section describes features of *virial* equations, an important class of equations of state for real (nonideal) gases.

2.2.5 Virial equations of state for pure gases

In later chapters of this book there will be occasion to apply thermodynamic derivations to virial equations of state of a pure gas or gas mixture. These formulas accurately describe the gas at low and moderate pressures using empirically determined, temperature-dependent parameters. The equations may be derived from statistical mechanics, so they have a theoretical as well as empirical foundation.

There are two forms of virial equations for a pure gas: one a series in powers of $1/V_m$:

$$pV_m = RT \left(1 + \frac{B}{V_m} + \frac{C}{V_m^2} + \dots \right) \quad (2.2.2)$$

and the other a series in powers of p :

$$pV_m = RT (1 + B_p p + C_p p^2 + \dots) \quad (2.2.3)$$

The parameters B , C , ... are called the *second*, *third*, ... *virial coefficients*, and the parameters B_p , C_p , ... are a set of pressure virial coefficients. Their values depend on the substance and are functions of temperature. (The *first* virial coefficient in both power series is 1, because pV_m must approach RT as $1/V_m$ or p approach zero at constant T .) Coefficients beyond the third virial coefficient are small and rarely evaluated.

The values of the virial coefficients for a gas at a given temperature can be determined from the dependence of p on V_m at this temperature. The value of the second virial coefficient B depends on pairwise interactions between the atoms or molecules of the gas, and in some cases can be calculated to good accuracy from statistical mechanics theory and a realistic intermolecular potential function.

To find the relation between the virial coefficients of Eq. 2.2.2 and the parameters B_p , C_p , ... in Eq. 2.2.3, we solve Eq. 2.2.2 for p in terms of V_m

$$p = RT \left(\frac{1}{V_m} + \frac{B}{V_m^2} + \dots \right) \quad (2.2.4)$$

and substitute in the right side of Eq. 2.2.3:

$$pV_m = RT \left[1 + B_p RT \left(\frac{1}{V_m} + \frac{B}{V_m^2} + \dots \right) + C_p (RT)^2 \left(\frac{1}{V_m} + \frac{B}{V_m^2} + \dots \right)^2 + \dots \right] \quad (2.2.5)$$

Then we equate coefficients of equal powers of $1/V_m$ in Eqs. 2.2.2 and 2.2.5 (since both equations must yield the same value of pV_m for any value of $1/V_m$):

$$B = RTB_p \quad (2.2.6)$$

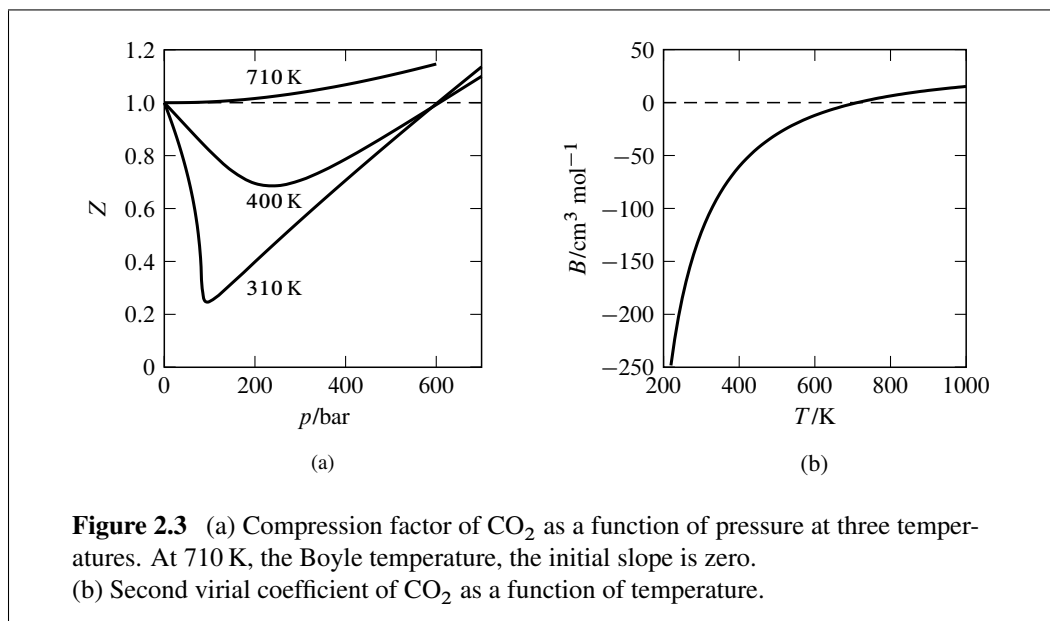

Figure 2.3 (a) Compression factor of CO_2 as a function of pressure at three temperatures. At 710 K, the Boyle temperature, the initial slope is zero. (b) Second virial coefficient of CO_2 as a function of temperature.

$$C = B_p RTB + C_p (RT)^2 = (RT)^2 (B_p^2 + C_p) \quad (2.2.7)$$

In the last equation, we have substituted for B from Eq. 2.2.6.

At pressures up to at least one bar, the terms beyond $B_p p$ in the pressure power series of Eq. 2.2.3 are negligible; then pV_m may be approximated by $RT(1 + B_p p)$, giving, with the help of Eq. 2.2.6, the simple approximate equation of state³

$$V_m \approx \frac{RT}{p} + B \quad (2.2.8)$$

(pure gas, $p \leq 1$ bar)

The **compression factor** (or compressibility factor) Z of a gas is defined by

$$Z \stackrel{\text{def}}{=} \frac{pV}{nRT} = \frac{pV_m}{RT} \quad (2.2.9)$$

(gas)

When a gas at a particular temperature and pressure satisfies the ideal gas equation, the value of Z is 1. The virial equations rewritten using Z are

$$Z = 1 + \frac{B}{V_m} + \frac{C}{V_m^2} + \dots \quad (2.2.10)$$

$$Z = 1 + B_p p + C_p p^2 + \dots \quad (2.2.11)$$

These equations show that the second virial coefficient B is the initial slope of the curve of a plot of Z versus $1/V_m$ at constant T , and B_p is the initial slope of Z versus p at constant T .

The way in which Z varies with p at different temperatures is shown for the case of carbon dioxide in Fig. 2.3(a).

³Guggenheim (Ref. [76]) calls a gas with this equation of state a *slightly imperfect gas*.

A temperature at which the initial slope is zero is called the **Boyle temperature**, which for CO_2 is 710 K. Both B and B_p must be zero at the Boyle temperature. At lower temperatures B and B_p are negative, and at higher temperatures they are positive—see Fig. 2.3(b). This kind of temperature dependence is typical for other gases. Experimentally, and also according to statistical mechanical theory, B and B_p for a gas can be zero only at a single Boyle temperature.

The fact that at any temperature other than the Boyle temperature B is nonzero is significant since it means that in the limit as p approaches zero at constant T and the gas approaches ideal-gas behavior, the *difference* between the actual molar volume V_m and the ideal-gas molar volume RT/p does not approach zero. Instead, $V_m - RT/p$ approaches the nonzero value B (see Eq. 2.2.8). However, the *ratio* of the actual and ideal molar volumes, $V_m/(RT/p)$, approaches unity in this limit.

Virial equations of gas *mixtures* will be discussed in Sec. 9.3.4.

2.2.6 Solids

A solid phase responds to a small applied stress by undergoing a small *elastic deformation*. When the stress is removed, the solid returns to its initial shape and the properties return to those of the unstressed solid. Under these conditions of small stress, the solid has an equation of state just as a fluid does, in which p is the pressure of a fluid surrounding the solid (the hydrostatic pressure) as explained in Sec. 2.3.5. The stress is an additional independent variable. For example, the length of a metal spring that is elastically deformed is a unique function of the temperature, the pressure of the surrounding air, and the stretching force.

If, however, the stress applied to the solid exceeds its elastic limit, the response is *plastic deformation*. This deformation persists when the stress is removed, and the unstressed solid no longer has its original properties. Plastic deformation is a kind of hysteresis, and is caused by such microscopic behavior as the slipping of crystal planes past one another in a crystal subjected to shear stress, and conformational rearrangements about single bonds in a stretched macromolecular fiber. Properties of a solid under plastic deformation depend on its past history and are not unique functions of a set of independent variables; an equation of state does not exist.

2.3 Some Basic Properties and Their Measurement

This section discusses aspects of the macroscopic properties mass, amount of substance, volume, density, pressure, and temperature, with examples of how these properties can be measured.

2.3.1 Mass

The SI unit of mass is the **kilogram**. The practical measurement of the mass of a body is with a balance utilizing the downward force exerted on the body by the earth's gravitational field. The classic balance has a beam and knife-edge arrangement to compare the gravitational force on the body with the gravitational force on a weight of known mass. A modern balance (strictly speaking a *scale*) incorporates a strain gauge or comparable device to directly measure the gravitational force on the unknown mass; this type must be calibrated

with known masses. The most accurate measurements take into account the effect of the buoyancy of the body and the calibration masses in air.

The accuracy of the calibration masses should be traceable to a national standard kilogram (which in the United States is maintained at NIST, the National Institute of Standards and Technology, in Gaithersburg, Maryland) and ultimately to the international prototype (page 20).

The 2019 revision of the SI replaces the international prototype with a new definition of the kilogram (Appendix A). The present method of choice for applying this definition to the precise measurement of a mass, with an uncertainty of several parts in 10^8 , uses an elaborate apparatus called a watt balance or *Kibble balance*.⁴ By this method, the mass of the international prototype is found to be 1 kg to within 1×10^{-8} kg.⁵

The NIST-4 Kibble balance⁶ at NIST has a balance wheel, from one side of which is suspended a coil of wire placed in a magnetic field, and from the other side a tare weight. In use, the balance position of the wheel is established. The test weight of unknown mass m is added to the coil side and a current passed through the coil, generating an upward force on this side due to the magnetic field. The current I is adjusted to reestablish the balance position. The balance condition is that the downward gravitational force on the test weight be equal in magnitude to the upward electromagnetic force: $mg = BIl$, where g is the acceleration of free fall, B is the magnetic flux density, l is the wire length of the coil, and I is the current carried by the wire.

B and I can't be measured precisely, so in a second calibration step the test weight is removed, the current is turned off, and the coil is moved vertically through the magnetic field at a constant precisely-measured speed v . This motion induces an electric potential difference between the two ends of the coil wire given by $\Delta\phi = Blv$.

By eliminating the product Bl from between the two preceding equations, the mass of the test weight can be calculated from $m = I\Delta\phi/gv$. For this calculation, I and $\Delta\phi$ are measured to a very high degree of precision during the balance operations by instrumental methods (Josephson and quantum Hall effects) requiring the defined value of the Planck constant h ; the value of g at the location of the apparatus is measured with a gravimeter.

2.3.2 Amount of substance

The SI unit of amount of substance (called simply the *amount* in this book) is the **mole** (Sec. 1.1.2). Chemists are familiar with the fact that, although the mole is a counting unit, an amount in moles is measured not by counting but by weighing. The SI revision of 2019 makes a negligible change to calculations involving the mole (page 20), so the previous definition of the mole remains valid for most purposes: twelve grams of carbon-12, the most abundant isotope of carbon, contains one mole of atoms.

The *relative atomic mass* or *atomic weight* A_r of an atom is a dimensionless quantity equal to the atomic mass relative to $A_r = 12$ for carbon-12. The *relative molecular mass* or *molecular weight* M_r of a molecular substance, also dimensionless, is the molecular mass relative to carbon-12. Thus the amount n of a substance of mass m can be calculated from

$$n = \frac{m}{A_r \text{ g mol}^{-1}} \quad \text{or} \quad n = \frac{m}{M_r \text{ g mol}^{-1}} \quad (2.3.1)$$

⁴Ref. [27] ⁵Ref. [165], Appendix 2. ⁶Ref. [78]

Table 2.2 Representative measurement methods

Physical quantity	Method	Typical value	Approximate uncertainty
Mass	analytical balance	100 g	0.1 mg
	microbalance	20 mg	0.1 μg
Volume	pipet, Class A	10 mL	0.02 mL
	volumetric flask, Class A	1 L	0.3 mL
Density	pycnometer, 25-mL capacity	1 g mL ⁻¹	2 mg mL ⁻¹
	magnetic float densimeter	1 g mL ⁻¹	0.1 mg mL ⁻¹
	vibrating-tube densimeter	1 g mL ⁻¹	0.01 mg mL ⁻¹
Pressure	mercury manometer or barometer	760 Torr	0.001 Torr
	diaphragm gauge	100 Torr	1 Torr
Temperature	constant-volume gas thermometer	10 K	0.001 K
	mercury-in-glass thermometer	300 K	0.01 K
	platinum resistance thermometer	300 K	0.0001 K
	monochromatic optical pyrometer	1300 K	0.03 K

A related quantity is the **molar mass** M of a substance, defined as the mass divided by the amount:

$$M \stackrel{\text{def}}{=} \frac{m}{n} \quad (2.3.2)$$

(The symbol M for molar mass is an exception to the rule given on page 29 that a subscript m is used to indicate a molar quantity.) The numerical value of the molar mass expressed in units of g mol⁻¹ is equal to the relative atomic or molecular mass:

$$M/\text{g mol}^{-1} = A_r \quad \text{or} \quad M/\text{g mol}^{-1} = M_r \quad (2.3.3)$$

2.3.3 Volume

Liquid volumes are commonly measured with precision volumetric glassware such as burets, pipets, and volumetric flasks. The National Institute of Standards and Technology in the United States has established specifications for “Class A” glassware; two examples are listed in Table 2.2. The volume of a vessel at one temperature may be accurately determined from the mass of a liquid of known density, such as water, that fills the vessel at this temperature.

The SI unit of volume is the cubic meter, but chemists commonly express volumes in units of liters and milliliters. The **liter** is defined as one cubic decimeter (Table 1.3). One cubic meter is the same as 10³ liters and 10⁶ milliliters. The *milliliter* is identical to the cubic centimeter.

Before 1964, the liter had a different definition: it was the volume of 1 kilogram of water at 3.98 °C, the temperature of maximum density. This definition made one liter equal to 1.000028 dm³. Thus, a numerical value of volume (or density) reported before 1964 and based on the liter as then defined may need a small correction in order to be consistent with the present definition of the liter.

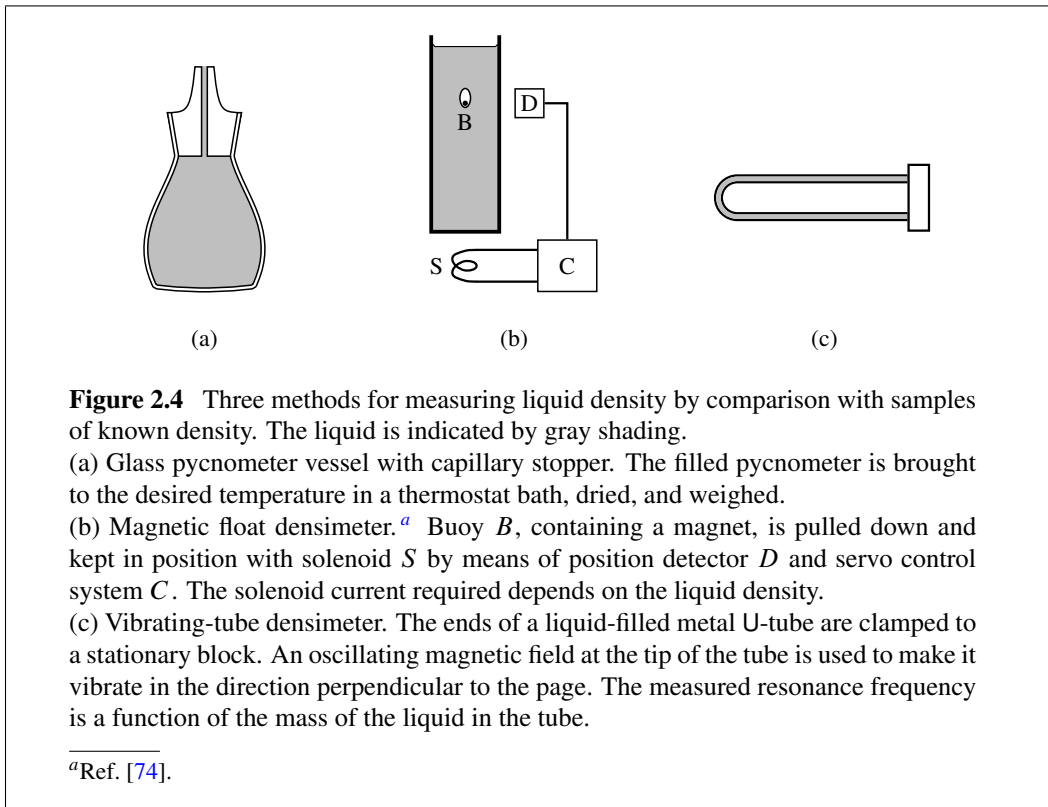

2.3.4 Density

Density, an intensive property, is defined as the ratio of the two extensive properties mass and volume:

$$\rho \stackrel{\text{def}}{=} \frac{m}{V} \quad (2.3.4)$$

The molar volume V_m of a homogeneous pure substance is inversely proportional to its density. From Eqs. 2.1.2, 2.3.2, and 2.3.4, we obtain the relation

$$V_m = \frac{M}{\rho} \quad (2.3.5)$$

Various methods are available for determining the density of a phase, many of them based on the measurement of the mass of a fixed volume or on a buoyancy technique. Three examples are shown in Fig. 2.4. Similar apparatus may be used for gases. The density of a solid may be determined from the volume of a nonreacting liquid (e.g., mercury) displaced by a known mass of the solid, or from the loss of weight due to buoyancy when the solid is suspended by a thread in a liquid of known density.

2.3.5 Pressure

Pressure is a force per unit area. Specifically, it is the normal component of stress exerted by an isotropic fluid on a surface element.⁷ The surface can be an interface surface between the fluid and another phase, or an imaginary dividing plane within the fluid.

⁷A liquid crystal and a polar liquid in a electric field are examples of fluids that are not isotropic, because they have different macroscopic properties in different directions.

Pressure is usually a positive quantity. Because cohesive forces exist in a liquid, it may be possible to place the liquid under tension and create a *negative* pressure. For instance, the pressure is negative at the top of a column of liquid mercury suspended below the closed end of a capillary tube that has no vapor bubble. Negative pressure in a liquid is an unstable condition that can result in spontaneous vaporization.

The SI unit of pressure is the **pascal**. Its symbol is Pa. One pascal is a force of one newton per square meter (Table 1.2).

Chemists are accustomed to using the non-SI units of millimeters of mercury, torr, and atmosphere. One millimeter of mercury (symbol mmHg) is the pressure exerted by a column exactly 1 mm high of a fluid of density equal to exactly $13.5951 \text{ g cm}^{-3}$ (the density of mercury at 0°C) in a place where the acceleration of free fall, g , has its standard value g_n (see Appendix B). One atmosphere is defined as exactly $1.01325 \times 10^5 \text{ Pa}$ (Table 1.3). The torr is defined by letting one atmosphere equal exactly 760 Torr. One atmosphere is approximately 760 mmHg. In other words, the millimeter of mercury and the torr are practically identical; they differ from one another by less than 2×10^{-7} Torr.

Another non-SI pressure unit is the **bar**, equal to exactly 10^5 Pa . A pressure of one bar is approximately one percent smaller than one atmosphere. This book often refers to a **standard pressure**, p° . In the past, the value of p° was usually taken to be 1 atm, but since 1982 the IUPAC has recommended the value $p^\circ = 1 \text{ bar}$.

A variety of manometers and other devices is available to measure the pressure of a fluid, each type useful in a particular pressure range. Some devices measure the pressure of the fluid directly. Others measure the differential pressure between the fluid and the atmosphere; the fluid pressure is obtained by combining this measurement with the atmospheric pressure measured with a barometer.

Within a *solid*, pressure cannot be defined simply as a force per unit area. Macroscopic forces at a point within a solid are described by the nine components of a stress tensor. The statement that a solid *has* or *is at* a certain pressure means that this is the hydrostatic pressure exerted on the solid's exterior surface. Thus, a solid immersed in a uniform isotropic fluid of pressure p is at pressure p ; if the fluid pressure is constant over time, the solid is at constant pressure.

2.3.6 Temperature

Temperature and thermometry are of fundamental importance in thermodynamics. Unlike the other physical quantities discussed in this chapter, temperature does not have a single unique definition. The chosen definition, whatever it may be, requires a *temperature scale* described by an operational method of measuring temperature values. For the scale to be useful, the values should increase monotonically with the increase of what we experience physiologically as the degree of "hotness." We can define a satisfactory scale with any measuring method that satisfies this requirement. The values on a particular temperature scale correspond to a particular physical quantity and a particular temperature unit.

For example, suppose you construct a simple liquid-in-glass thermometer with equally spaced marks along the stem and number the marks consecutively. To define a temperature scale and a temperature unit, you could place the thermometer in thermal contact with a body whose temperature is to be measured, wait until the indicating liquid reaches a stable position, and read the meniscus position by linear interpolation between two marks. Of course, placing the thermometer and body in thermal contact may affect the body's

temperature. The measured temperature is that of the body *after* thermal equilibrium is achieved.

Thermometry is based on the principle that the temperatures of different bodies may be compared with a thermometer. For example, if you find by separate measurements with your thermometer that two bodies give the same reading, you know that within experimental error both have the same temperature. The significance of two bodies having the same temperature (on any scale) is that if they are placed in thermal contact with one another, they will prove to be in thermal equilibrium with one another as evidenced by the absence of any changes in their properties. This principle is sometimes called the *zeroth law of thermodynamics*, and was first stated as follows by J. C. Maxwell (1872): “Bodies whose temperatures are equal to that of the same body have themselves equal temperatures.”

Equilibrium systems for fixed temperatures

The *ice point* is the temperature at which ice and air-saturated water coexist in equilibrium at a pressure of one atmosphere. The *steam point* is the temperature at which liquid and gaseous H_2O coexist in equilibrium at one atmosphere. Neither of these temperatures has sufficient reproducibility for high-precision work. The temperature of the ice-water-air system used to define the ice point is affected by air bubbles in the ice and by varying concentrations of air in the water around each piece of ice. The steam point is uncertain because the temperature of coexisting liquid and gas is a sensitive function of the experimental pressure.

The melting point of the solid phase of a pure substance is a more reproducible temperature. When the solid and liquid phases of a pure substance coexist at a controlled, constant pressure, the temperature has a definite fixed value.

Triple points of pure substances provide the most reproducible temperatures. Both temperature and pressure have definite fixed values in a system containing coexisting solid, liquid, and gas phases of a pure substance.

Figure 2.5 on the next page illustrates a triple-point cell for water whose temperature is capable of a reproducibility within 10^{-4} K. When ice, liquid water, and water vapor are in equilibrium in this cell, the cell is at the triple point of water.

Temperature scales

Six different temperature scales are described below: the ideal-gas temperature scale, the thermodynamic temperature scale, the obsolete centigrade scale, the Celsius scale, the International Temperature Scale of 1990, and the Provisional Low Temperature Scale of 2000.

The *ideal-gas temperature scale* is defined by gas thermometry measurements, as described on page 44. The *thermodynamic temperature scale* is defined by the behavior of a theoretical Carnot engine, as explained in Sec. 4.3.4. These temperature scales correspond to the physical quantities called ideal-gas temperature and thermodynamic temperature, respectively. Although the two scales have different definitions, the two temperatures turn out (Sec. 4.3.4) to be proportional to one another. Their values become identical when the same unit of temperature is used for both.

Prior to the 2019 SI revision, the **kelvin** was defined by specifying that a system containing the solid, liquid, and gaseous phases of H_2O coexisting at equilibrium with one another (the *triple point of water*) has a thermodynamic temperature of exactly 273.16 kelvins. (This

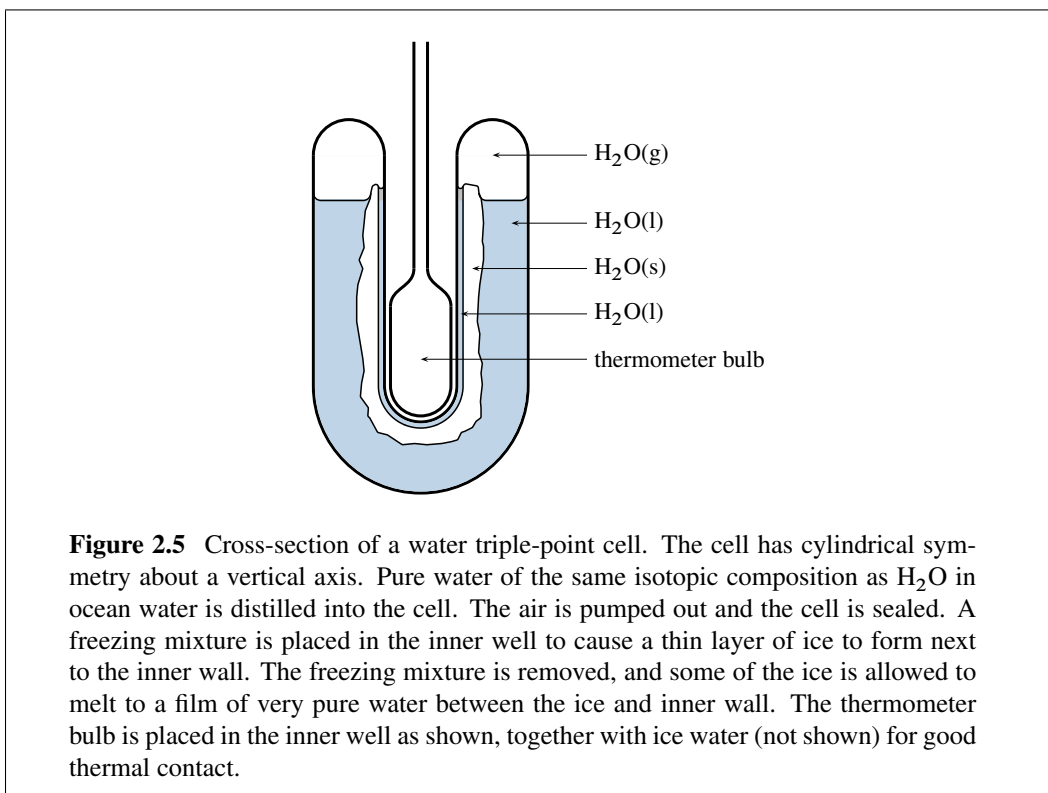

Figure 2.5 Cross-section of a water triple-point cell. The cell has cylindrical symmetry about a vertical axis. Pure water of the same isotopic composition as H_2O in ocean water is distilled into the cell. The air is pumped out and the cell is sealed. A freezing mixture is placed in the inner well to cause a thin layer of ice to form next to the inner wall. The freezing mixture is removed, and some of the ice is allowed to melt to a film of very pure water between the ice and inner wall. The thermometer bulb is placed in the inner well as shown, together with ice water (not shown) for good thermal contact.

value was chosen to make the steam point approximately one hundred kelvins greater than the ice point.) The ideal-gas temperature of this system was set equal to the same value, 273.16 kelvins, making temperatures measured on the two scales identical.

The 2019 SI revision treats the triple point temperature of water as a value to be determined experimentally by primary thermometry (page 43). The result is 273.16 kelvins to within 1×10^{-7} K.⁸ Thus there is no practical difference between the old and new definitions of the kelvin.

Formally, the symbol T refers to thermodynamic temperature. Strictly speaking, a different symbol should be used for ideal-gas temperature. Since the two kinds of temperatures have identical values, this book will use the symbol T for both and refer to both physical quantities simply as “temperature” except when it is necessary to make a distinction.

The obsolete *centigrade scale* was defined to give a value of exactly 0 degrees centigrade at the ice point and a value of exactly 100 degrees centigrade at the steam point, and to be a linear function of an ideal-gas temperature scale.

The centigrade scale has been replaced by the *Celsius scale*, the thermodynamic (or ideal-gas) temperature scale shifted by exactly 273.15 kelvins. The temperature unit is the degree Celsius ($^{\circ}\text{C}$), identical in size to the kelvin. Thus, Celsius temperature t is related to thermodynamic temperature T by

$$t/^{\circ}\text{C} = T/\text{K} - 273.15 \quad (2.3.6)$$

On the Celsius scale, the triple point of water is exactly 0.01°C . The ice point is 0°C to within 0.0001°C , and the steam point is 99.97°C .

⁸Ref. [165], Appendix 2.

Table 2.3 Fixed temperatures of the International Temperature Scale of 1990

T_{90}/K	Equilibrium system
13.8033	H ₂ triple point
24.5561	Ne triple point
54.3584	O ₂ triple point
83.8058	Ar triple point
234.3156	Hg triple point
273.16	H ₂ O triple point
302.9146	Ga melting point at 1 atm
429.7485	In melting point at 1 atm
505.078	Sn melting point at 1 atm
692.677	Zn melting point at 1 atm
933.473	Al melting point at 1 atm
1234.93	Ag melting point at 1 atm
1337.33	Au melting point at 1 atm
1357.77	Cu melting point at 1 atm

The *International Temperature Scale of 1990* (abbreviated ITS-90) defines the physical quantity called international temperature, with symbol T_{90} .⁹ Each value of T_{90} is intended to be very close to the corresponding thermodynamic temperature T .

The ITS-90 scale is defined over a very wide temperature range, from 0.65 K up to at least 1358 K. There is a specified procedure for each measurement of T_{90} , depending on the range in which T falls: vapor-pressure thermometry (0.65–5.0 K), gas thermometry (3.0–24.5561 K), platinum-resistance thermometry (13.8033–1234.93 K), or optical pyrometry (above 1234.93 K). For vapor-pressure thermometry, the ITS-90 scale provides formulas for T_{90} in terms of the vapor pressure of the helium isotopes ³He and ⁴He. For the other methods, it assigns values of fourteen fixed calibration temperatures achieved with the reproducible equilibrium systems listed in Table 2.3, and provides interpolating functions for intermediate temperatures.

The *Provisional Low Temperature Scale of 2000* (PLST-2000) is for temperatures between 0.0009 K and 1 K. This scale is based on the melting temperature of solid ³He as a function of pressure. For ³He at these temperatures, the required pressures are in the range 30–40 bar.¹⁰

The temperatures defined by the ITS-90 and PLST-2000 temperature scales are exact with respect to the respective scale—their values remain unchanged during the life of the scale.¹¹

Primary thermometry

Primary thermometry is the measurement of temperature based on fundamental physical principles. Until about 1960, primary measurements of T involved gas thermometry. Other more accurate methods are now being used; they require elaborate equipment and are not convenient for routine measurements of T .

⁹Refs. [121] and [146]. ¹⁰Ref. [157]. ¹¹Ref. [56].

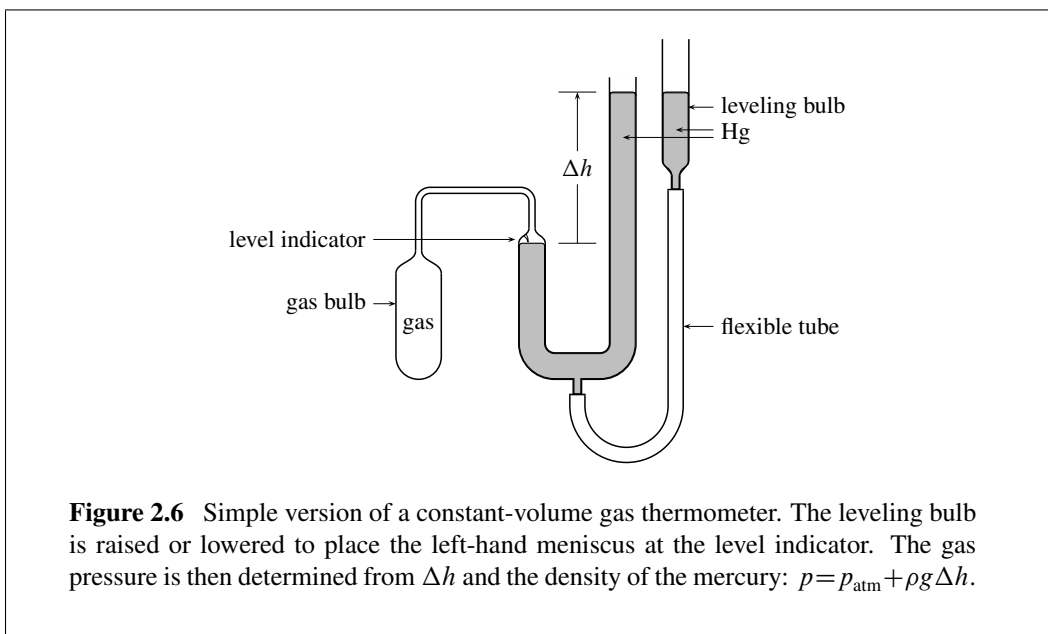

The methods of primary thermometry require the value of the Boltzmann constant k or the gas constant $R = N_A k$, where N_A is the Avogadro constant. k and N_A are defining constants of the 2019 revision of the SI. Using these fixed values (Appendix B) in the calculations results in values of T consistent with the definition of the kelvin according to the 2019 revision.

Gas thermometry is based on the ideal gas equation $T = pV/nR$. It is most commonly carried out with a *constant-volume gas thermometer*. This device consists of a bulb or vessel containing a thermometric gas and a means of measuring the pressure of this gas. The thermometric gas is usually helium, because it has minimal deviations from ideal-gas behavior.

The simple constant-volume gas thermometer depicted in Fig. 2.6 uses a mercury manometer to measure the pressure. More sophisticated versions have a diaphragm pressure transducer between the gas bulb and the pressure measurement system.

One procedure for determining the value of an unknown temperature involves a pair of pressure measurements. The gas is brought successively into thermal equilibrium with two different systems: a reference system of known temperature T_1 (such as one of the systems listed in Table 2.3), and the system whose temperature T_2 is to be measured. The pressures p_1 and p_2 are measured at these temperatures. In the two equilibrations the amount of gas is the same and the gas volume is the same except for a small change due to effects of T and p on the gas bulb dimensions.

If the gas exactly obeyed the ideal gas equation in both measurements, we would have $nR = p_1 V_1 / T_1 = p_2 V_2 / T_2$ or $T_2 = T_1 (p_2 V_2 / p_1 V_1)$. Since, however, the gas approaches ideal behavior only in the limit of low pressure, it is necessary to make a series of the paired measurements, changing the amount of gas in the bulb before each new pair so as to change the measured pressures in discrete steps. Thus, the operational equation for evaluating the

unknown temperature is

$$T_2 = T_1 \lim_{p_1 \rightarrow 0} \frac{p_2 V_2}{p_1 V_1} \quad (2.3.7)$$

(gas)

(The ratio V_2/V_1 differs from unity only because of any change in the gas bulb volume when T and p change.) The limiting value of $p_2 V_2/p_1 V_1$ can be obtained by plotting this quantity against p_1 , $1/V_m$, or another appropriate extrapolating function. Note that values of n and R are not needed.

Another method is possible if the value of the second virial coefficient at the reference temperature T_1 is known. This value can be used in the virial equation (Eq. 2.2.2) together with the values of T_1 and p_1 to evaluate the molar volume V_m . Then, assuming V_m is the same in both equilibrations of a measurement pair, it is possible to evaluate $p_2 V_m/R$ at temperature T_2 , and T_2 can be found from

$$T_2 = \lim_{p_2 \rightarrow 0} \frac{p_2 V_m}{R} \quad (2.3.8)$$

(gas)

Constant-volume gas thermometry can be used to evaluate the second virial coefficient of the gas at temperature T_2 if the value at T_1 is known (Prob. 2.3).

The principles of measurements with a gas thermometer are simple, but in practice great care is needed to obtain adequate precision and accuracy. Corrections or precautions are required for such sources of error as thermal expansion of the gas bulb, “dead volume” between the bulb and pressure measurement system, adsorption of the thermometric gas on interior surfaces, and desorption of surface contaminants.

Since 1960 primary methods with lower uncertainty than gas thermometry have been developed and improved. *Acoustic gas thermometry* is based on the speed of sound in an ideal monatomic gas (helium or argon).¹² The gas is confined in a metal cavity resonator of known internal dimensions. The thermodynamic temperature of the gas is calculated from $T = (3/5)Mv^2/R$, where M is the average molar mass of the gas and v is the measured speed of sound in the limit of zero frequency. To evaluate T in a phase of interest, small thermometers such as platinum resistor thermometers (page 46) are moved from thermal contact with the phase to the outside of the metal resonator shell, and the readings compared.

Values of thermodynamic temperatures T in the range 118 K to 323 K obtained by acoustic gas thermometry agree with T_{90} on the ITS-90 scale to within 0.006 K.¹³ The agreement becomes better the closer T is to the water triple point 273.16 K. T and T_{90} are equal at 273.16 K.

Other kinds of primary thermometry capable of low uncertainty include¹⁴

- *Dielectric constant gas thermometry*, based on the variation of the dielectric constant of an ideal gas with temperature;
- *Johnson noise thermometry*, based on measurements of the mean-square noise voltage developed in a resistor;
- *Doppler broadening thermometry*, based on measurements of the Doppler width of the absorption line when a laser beam passes through a gas.

¹²Ref. [128]. ¹³Ref. [172]. ¹⁴Ref. [60].

Practical thermometers

Liquid-in-glass thermometers use indicating liquids whose volume change with temperature is much greater than that of the glass. A mercury-in-glass thermometer can be used in the range 234 K (the freezing point of mercury) to 600 K, and typically can be read to 0.01 K. A Beckmann thermometer covers a range of only a few kelvins but can be read to 0.001 K.

A *resistance thermometer* is included in a circuit that measures the thermometer's electric resistance. Platinum resistance thermometers are widely used because of their stability and high sensitivity (0.0001 K). Thermistors use metal oxides and can be made very small; they have greater sensitivity than platinum resistance thermometers but are not as stable over time.

A *thermocouple* consists of wires of two dissimilar metals (e.g., constantan alloy and copper) connected in series at soldered or welded junctions. A many-junction thermocouple is called a *thermopile*. When adjacent junctions are placed in thermal contact with bodies of different temperatures, an electric potential develops that is a function of the two temperatures.

Finally, two other temperature-measuring devices are the *quartz crystal thermometer*, incorporating a quartz crystal whose resonance frequency is temperature dependent, and *optical pyrometers*, which are useful above about 1300 K to measure the radiant intensity of a black body emitter.

The national laboratories of several countries, including the National Institute of Standards and Technology in the United States, maintain stable secondary thermometers (e.g., platinum resistance thermometers and thermocouples) that have been calibrated according to the ITS-90 scale. These secondary thermometers are used as working standards to calibrate other laboratory and commercial temperature-measuring devices.

The PLTS-2000 scale from 0.9 mK to 1 K and the ITS-90 scale from 0.65 K upwards are expected to continue to be used for precise, reproducible and practical approximations to thermodynamic temperature. In the temperature range 23 K–1233 K, the most precise measurements will be traceable to platinum resistance thermometers calibrated according to the ITS-90 scale.¹⁵

2.4 The State of the System

The thermodynamic **state** of the system is an important and subtle concept.

Do not confuse the *state* of the system with the kind of *physical state* or state of aggregation of a phase discussed in Sec. 2.2.1. A *change of state* refers to a change in the state of the system, not necessarily to a phase transition.

At each instant of time, the system is in some definite state that we may describe with values of the macroscopic properties we consider to be relevant for our purposes. The values of these properties at any given instant define the state at that instant. Whenever the value of any of these properties changes, the state has changed. If we subsequently find that each of the relevant properties has the value it had at a certain previous instant, then the system has returned to its previous state.

¹⁵Ref. [56].

Table 2.4 Values of state functions of an aqueous sucrose solution (A = water, B = sucrose)

temperature	$T = 293.15 \text{ K}$
pressure	$p = 1.01 \text{ bar}$
amount of water	$n_{\text{A}} = 39.18 \text{ mol}$
amount of sucrose	$n_{\text{B}} = 1.375 \text{ mol}$
volume	$V = 1000 \text{ cm}^3$
mass	$m = 1176.5 \text{ g}$
density	$\rho = 1.1765 \text{ g cm}^{-3}$
mole fraction of sucrose	$x_{\text{B}} = 0.03390$
osmotic pressure	$\Pi = 58.2 \text{ bar}$
refractive index, sodium D line	$n_{\text{D}} = 1.400$

2.4.1 State functions and independent variables

The properties whose values at each instant depend only on the state of the system at that instant, and not on the past or future history of the system, are called **state functions** (or state variables, or state parameters). There may be other system properties that we consider to be irrelevant to the state, such as the shape of the system, and these are *not* state functions.

Various conditions determine what states of a system are physically possible. If a uniform phase has an equation of state, property values must be consistent with this equation. The system may have certain built-in or externally-imposed conditions or constraints that keep some properties from changing with time. For instance, a closed system has constant mass; a system with a rigid boundary has constant volume. We may know about other conditions that affect the properties during the time the system is under observation.

We can define the state of the system with the values of a certain minimum number of state functions which we treat as the **independent variables**. Once we have selected a set of independent variables, consistent with the physical nature of the system and any conditions or constraints, we can treat all other state functions as **dependent variables** whose values depend on the independent variables.

Whenever we adjust the independent variables to particular values, every other state function is a dependent variable that can have only one definite, reproducible value. For example, in a single-phase system of a pure substance with T , p , and n as the independent variables, the volume is determined by an equation of state in terms of T , p , and n ; the mass is equal to nM ; the molar volume is given by $V_{\text{m}} = V/n$; and the density is given by $\rho = nM/V$.

2.4.2 An example: state functions of a mixture

Table 2.4 lists the values of ten state functions of an aqueous sucrose solution in a particular state. The first four properties (T , p , n_{A} , n_{B}) are ones that we can vary independently, and their values suffice to define the state for most purposes. Experimental measurements will convince us that, whenever these four properties have these particular values, each of the other properties has the one definite value listed—we cannot alter any of the other properties without changing one or more of the first four variables. Thus we can take T , p , n_{A} , and n_{B} as the independent variables, and the six other properties as dependent variables. The other properties include one (V) that is determined by an equation of state; three (m , ρ ,

and x_B) that can be calculated from the independent variables and the equation of state; a solution property (Π) treated by thermodynamics (Sec. 12.4.4); and an optical property (n_D). In addition to these six dependent variables, this system has innumerable others: energy, isothermal compressibility, heat capacity at constant pressure, and so on.

We could make other choices of the independent variables for the aqueous sucrose system. For instance, we could choose the set T , p , V , and x_B , or the set p , V , ρ , and x_B . If there are no imposed conditions, the *number* of independent variables of this system is always four. (Note that we could not arbitrarily choose just any four variables. For instance, there are only three independent variables in the set p , V , m , and ρ because of the relation $\rho = m/V$.)

If the system has imposed conditions, there will be fewer independent variables. Suppose the sucrose solution is in a closed system with fixed, known values of n_A and n_B ; then there are only two independent variables and we could describe the state by the values of just T and p .

2.4.3 More about independent variables

A closed system containing a single substance in a single phase has two independent variables, as we can see by the fact that the state is completely defined by values of T and p or of T and V .

A closed single-phase system containing a mixture of several nonreacting substances, or a mixture of reactants and products in reaction equilibrium, also has two independent variables. Examples are

- air, a mixture of gases in fixed proportions;
- an aqueous ammonia solution containing H_2O , NH_3 , NH_4^+ , H^+ , OH^- , and probably other species, all in rapid continuous equilibrium.

The systems in these two examples contain more than one substance, but only one *component*. The number of components of a system is the minimum number of substances or mixtures of fixed composition needed to form each phase.¹⁶ A system of a single pure substance is a special case of a system of one component. In an *open* system, the amount of each component can be used as an independent variable.

Consider a system with more than one uniform phase. In principle, for each phase we could independently vary the temperature, the pressure, and the amount of each substance or component. There would then be $2 + C$ independent variables for each phase, where C is the number of components in the phase.

There usually are, however, various equilibria and other conditions that reduce the number of independent variables. For instance, each phase may have the same temperature and the same pressure; equilibrium may exist with respect to chemical reaction and transfer between phases (Sec. 2.4.4); and the system may be closed. (While these various conditions do not *have* to be present, the relations among T , p , V , and amounts described by an equation of state of a phase are *always* present.) On the other hand, additional independent variables are required if we consider properties such as the surface area of a liquid to be relevant.¹⁷

¹⁶The concept of the number of components is discussed in more detail in Chap. 13.

¹⁷The important topic of the number of independent *intensive* variables is treated by the Gibbs phase rule, which will be discussed in Sec. 8.1.7 for systems of a single substance and in Sec. 13.1 for systems of more than one substance.

We must be careful to choose a set of independent variables that defines the state without ambiguity. For a closed system of liquid water, the set p and V might be a poor choice because the molar volume of water passes through a minimum as T is varied at constant p . Thus, the values $p = 1.000$ bar and $V = 18.016$ cm³ would describe one mole of water at both 2 °C and 6 °C, so these values would not uniquely define the state. Better choices of independent variables in this case would be either T and p , or else T and V .

How may we describe the state of a system that has nonuniform regions? In this case we may imagine the regions to be divided into many small volume elements or parcels, each small enough to be essentially uniform but large enough to contain many molecules. We then describe the state by specifying values of independent variables for each volume element. If there is internal macroscopic motion (e.g., flow), then velocity components can be included among the independent variables. Obviously, the quantity of information needed to describe a complicated state may be enormous.

We can imagine situations in which classical thermodynamics would be completely incapable of describing the state. For instance, turbulent flow in a fluid or a shock wave in a gas may involve inhomogeneities all the way down to the molecular scale. Macroscopic variables would not suffice to define the states in these cases.

Whatever our choice of independent variables, all we need to know to be sure a system is in the same state at two different times is that *the value of each independent variable is the same at both times*.

2.4.4 Equilibrium states

An **equilibrium state** is a state that, when present in an isolated system, remains unchanged indefinitely as long as the system remains isolated. (Recall that an isolated system is one that exchanges no matter or energy with the surroundings.) An equilibrium state of an isolated system has no natural tendency to change over time. If changes *do* occur in an isolated system, they continue until an equilibrium state is reached.

A system in an equilibrium state may have some or all of the following kinds of internal equilibria:

Thermal equilibrium: the temperature is uniform throughout.

Mechanical equilibrium: the pressure is uniform throughout.

Transfer equilibrium: there is equilibrium with respect to the transfer of each species from one phase to another.

Reaction equilibrium: every possible chemical reaction is at equilibrium.

A *homogeneous* system has a single phase of uniform temperature and pressure, and so has thermal and mechanical equilibrium. It is in an equilibrium state if it also has reaction equilibrium.

A *heterogeneous* system is in an equilibrium state if each of the four kinds of internal equilibrium is present.

The meaning of internal equilibrium in the context of an equilibrium state is that no perceptible change of state occurs during the period we keep the isolated system under observation. For instance, a system containing a homogeneous mixture of gaseous H₂ and O₂ at 25 °C and 1 bar is in a state of reaction equilibrium on a time scale of hours or days; but if a measurable amount of H₂O forms over a longer period, the state is not an equilibrium

state on this longer time scale. This consideration of time scale is similar to the one we apply to the persistence of deformation in distinguishing a solid from a fluid (Sec. 2.2.1).

Even if a system is not in internal equilibrium, it can be in an equilibrium state if a change of state is prevented by an imposed internal constraint or the influence of an external field. Here are five examples of such states:

- A system with an internal adiabatic partition separating two phases can be in an equilibrium state that is not in thermal equilibrium. The adiabatic partition allows the two phases to remain indefinitely at different temperatures. If the partition is rigid, it can also allow the two phases to have different pressures, so that the equilibrium state lacks mechanical equilibrium.
- An experimental system used to measure osmotic pressure (Fig. 12.2 on page 373) has a semipermeable membrane separating a liquid solution phase and a pure solvent phase. The membrane prevents the transfer of solute from the solution to the pure solvent. In the equilibrium state of this system, the solution has a higher pressure than the pure solvent; the system is then in neither transfer equilibrium nor mechanical equilibrium.
- In the equilibrium state of a galvanic cell that is not part of a closed electrical circuit (Sec. 3.8.3), the separation of the reactants and products and the open circuit are constraints that prevent the cell reaction from coming to reaction equilibrium.
- A system containing mixed reactants of a reaction can be in an equilibrium state without reaction equilibrium if we withhold a catalyst or initiator or introduce an inhibitor that prevents reaction. In the example above of a mixture of H_2 and O_2 gases, we could consider the high activation energy barrier for the formation of H_2O to be an internal constraint. If we remove the constraint by adding a catalyst, the reaction will proceed explosively.
- An example of a system influenced by an external field is a tall column of gas in a gravitational field (Sec. 8.1.4). In order for an equilibrium state to be established in this field, the pressure must decrease continuously with increasing elevation.

Keep in mind that regardless of the presence or absence of internal constraints and external fields, the essential feature of an equilibrium state is this: if we isolate the system while it is in this state, *the state functions do not change over time*.

Three additional comments can be made regarding the properties of equilibrium states.

1. It should be apparent that a system with thermal equilibrium has a single value of T , and one with mechanical equilibrium has a single value of p , and this allows the state to be described by a minimal number of independent variables. In contrast, the definition of a nonequilibrium state with nonuniform intensive properties may require a very large number of independent variables.
2. Strictly speaking, during a time period in which the system exchanges energy with the surroundings its state cannot be an equilibrium state. Energy transfer at a finite rate causes nonuniform temperature and pressure within the system and prevents internal thermal and mechanical equilibrium. If, however, the rate of energy transfer is small, then at each instant the state can closely approximate an equilibrium state. This topic will be discussed in detail in the next chapter.
3. The concept of an equilibrium state assumes that when the system is in this state and isolated, no observable change occurs during the period of experimental observation.

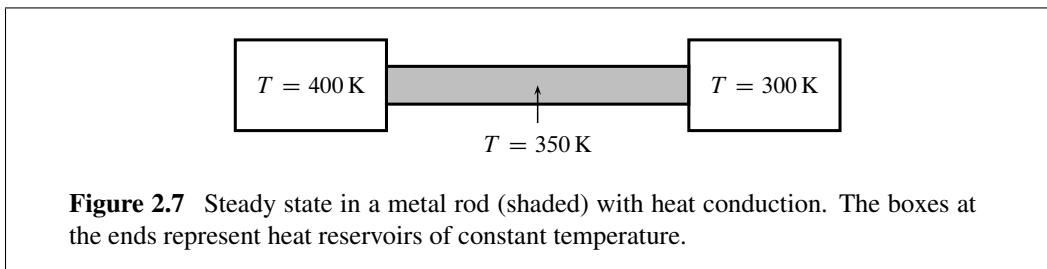

Figure 2.7 Steady state in a metal rod (shaded) with heat conduction. The boxes at the ends represent heat reservoirs of constant temperature.

If the state does, in fact, undergo a slow change that is too small to be detected during the experimental observation period Δt_{exp} , the state is *metastable*—the relaxation time of the slow change is much greater than Δt_{exp} . There is actually no such thing as a true equilibrium state, because very slow changes inevitably take place that we have no way of controlling. One example was mentioned above: the slow formation of water from its elements in the absence of a catalyst. Atoms of radioactive elements with long half-lives slowly change to other elements. More generally, all elements are presumably subject to eventual transmutation to iron-58 or nickel-62, the nuclei with the greatest binding energy per nucleon. When we use the concept of an equilibrium state, we are in effect assuming that rapid changes that have come to equilibrium have relaxation times much shorter than Δt_{exp} and that the relaxation times of all other changes are infinite.

2.4.5 Steady states

It is important not to confuse an equilibrium state with a **steady state**, a state that is constant during a time period during which the system exchanges matter or energy with the surroundings.

The heat-conducting metal rod shown in Fig. 2.7 is a system in such a steady state. Each end of the rod is in thermal contact with a **heat reservoir** (or **thermal reservoir**), which is a body or external system whose temperature remains constant and uniform when there is heat transfer to or from it.¹⁸ The two heat reservoirs in the figure have different temperatures, causing a temperature gradient to form along the length of the rod and energy to be transferred by heat from the warmer reservoir to the rod and from the rod to the cooler reservoir. Although the properties of the steady state of the rod remain constant, the rod is clearly not in an equilibrium state because the temperature gradient will quickly disappear when we isolate the rod by removing it from contact with the heat reservoirs.

2.5 Processes and Paths

A **process** is a change in the state of the system over time, starting with a definite initial state and ending with a definite final state. The process is defined by a **path**, which is the continuous sequence of consecutive states through which the system passes, including the initial state, the intermediate states, and the final state. The process has a direction along

¹⁸A heat reservoir can be a body that is so large that its temperature changes only imperceptibly during heat transfer, or an external system of coexisting phases of a pure substance (e.g., ice and water) at constant pressure.

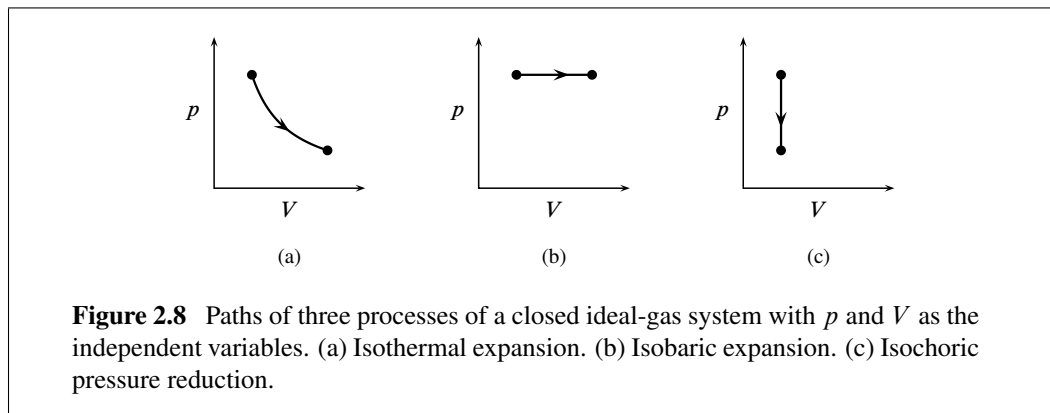

the path. The path could be described by a curve in an N -dimensional space in which each coordinate axis represents one of the N independent variables.

This book takes the view that a thermodynamic process is defined by what happens *within* the system, in the three-dimensional region up to and including the boundary, and by the forces exerted on the system by the surroundings and any external field. Conditions and changes in the surroundings are not part of the process except insofar as they affect these forces. For example, consider a process in which the system temperature decreases from 300 K to 273 K. We could accomplish this temperature change by placing the system in thermal contact with either a refrigerated thermostat bath or a mixture of ice and water. The process is the same in both cases, but the surroundings are different.

Expansion is a process in which the system volume increases; in **compression**, the volume decreases.

An **isothermal** process is one in which the temperature of the system remains uniform and constant. An **isobaric** or **isopiestic** process refers to uniform constant pressure, and an **isochoric** process refers to constant volume. Paths for these processes of an ideal gas are shown in Fig. 2.8.

An **adiabatic** process is one in which there is no heat transfer across any portion of the boundary. We may ensure that a process is adiabatic either by using an adiabatic boundary or, if the boundary is diathermal, by continuously adjusting the external temperature to eliminate a temperature gradient at the boundary.

Recall that a state function is a property whose value at each instant depends only on the state of the system at that instant. The finite change of a state function X in a process is written ΔX . The notation ΔX always has the meaning $X_2 - X_1$, where X_1 is the value in the initial state and X_2 is the value in the final state. Therefore, the value of ΔX depends only on the values of X_1 and X_2 . *The change of a state function during a process depends only on the initial and final states of the system, not on the path of the process.*

An infinitesimal change of the state function X is written dX . The mathematical operation of summing an infinite number of infinitesimal changes is integration, and the sum is an integral (see the brief calculus review in Appendix E). The sum of the infinitesimal changes of X along a path is a definite integral equal to ΔX :

$$\int_{X_1}^{X_2} dX = X_2 - X_1 = \Delta X \quad (2.5.1)$$

If dX obeys this relation—that is, if its integral for given limits has the same value regardless of the path—it is called an **exact differential**. The differential of a state function is always an exact differential.

A **cyclic process** is a process in which the state of the system changes and then returns to the initial state. In this case the integral of dX is written with a cyclic integral sign: $\oint dX$. Since a state function X has the same initial and final values in a cyclic process, X_2 is equal to X_1 and the cyclic integral of dX is zero:

$$\oint dX = 0 \quad (2.5.2)$$

Heat (q) and work (w) are examples of quantities that are *not* state functions. They are not even properties of the system; instead they are quantities of energy transferred across the boundary over a period of time. It would therefore be incorrect to write “ Δq ” or “ Δw .” Instead, the values of q and w depend in general on the path and are called **path functions**.

This book uses the symbol \bar{d} (lowercase letter “d” with a bar through the stem) for an infinitesimal quantity of a path function. Thus, $\bar{d}q$ and $\bar{d}w$ are infinitesimal quantities of heat and work. The sum of many infinitesimal quantities of a path function is the *net* quantity:

$$\int \bar{d}q = q \quad \int \bar{d}w = w \quad (2.5.3)$$

The infinitesimal quantities $\bar{d}q$ and $\bar{d}w$, because the values of their integrals depend on the path, are **inexact differentials**.¹⁹

There is a fundamental difference between a state function (such as temperature or volume) and a path function (such as heat or work): *The value of a state function refers to one instant of time; the value of a path function refers to an interval of time.*

State function and path function in thermodynamics are analogous to elevation and distance in climbing a mountain. Suppose there are several trails of different lengths from the trailhead to the summit. The climber at each instant is at a definite elevation, and the elevation change during the climb depends only on the trailhead and summit elevations and not on the trail used. Thus elevation is like a state function. The distance traveled by the climber depends on the trail, and is like a path function.

2.6 The Energy of the System

A large part of classical thermodynamics is concerned with the energy of the system. The total energy of a system is an extensive property whose value at any one instant cannot be measured in any practical way, but whose change is the focus of the first law of thermodynamics (Chap. 3).

2.6.1 Energy and reference frames

Classical thermodynamics ignores microscopic properties such as the behavior of individual atoms and molecules. Nevertheless, a consideration of the classical mechanics of particles

¹⁹Chemical thermodynamicists often write these quantities as dq and dw . Mathematicians, however, frown on using the same notation for inexact and exact differentials. Other notations sometimes used to indicate that heat and work are path functions are Dq and Dw , and also δq and δw .

will help us to understand the sources of the potential and kinetic energy of a thermodynamic system.

In classical mechanics, the energy of a collection of interacting point particles is the sum of the kinetic energy $\frac{1}{2}mv^2$ of each particle (where m is the particle's mass and v is its velocity), and of various kinds of potential energies. The potential energies are defined in such a way that if the particles are isolated from the rest of the universe, as the particles move and interact with one another the total energy (kinetic plus potential) is constant over time. This principle of the conservation of energy also holds for real atoms and molecules whose electronic, vibrational, and rotational energies, absent in point particles, are additional contributions to the total energy.

The positions and velocities of particles must be measured in a specified system of coordinates called a *reference frame*. This book will use reference frames with *Cartesian* axes. Since the kinetic energy of a particle is a function of velocity, the kinetic energy depends on the choice of the reference frame. A particularly important kind is an *inertial* frame, one in which Newton's laws of motion are obeyed (see Sec. G.1 in Appendix G).

A reference frame whose axes are fixed relative to the earth's surface is what this book will call a *lab frame*. A lab frame for all practical purposes is inertial (Sec. G.10 on page 503). It is in this kind of stationary frame that the laws of thermodynamics have been found by experiment to be valid.

The energy E of a thermodynamic system is the sum of the energies of the particles contained in it and the potential energies of interaction between these particles. Just as for an individual particle, the energy of the system depends on the reference frame in which it is measured. The energy of the system may change during a process, but the principle of the conservation of energy ensures that the sum of the energy of the system, the energy of the surroundings, and any energy shared by both, all measured in the same reference frame, remains constant over time.

This book uses the symbol E_{sys} for the energy of the system measured in a specified inertial frame. The system could be located in a weightless environment in outer space, and the inertial frame could be one that is either fixed or moving at constant velocity relative to local stars. Usually, however, the system is located in the earth's gravitational field, and the appropriate inertial frame is then an earth-fixed lab frame.

If during a process the system as a whole undergoes motion or rotation relative to the inertial frame, then E_{sys} depends in part on coordinates that are not properties of the system. In such situations E_{sys} is not a state function, and we need the concept of internal energy.

2.6.2 Internal energy

The **internal energy**, U , is the energy of the system measured in a reference frame that allows U to be a state function—that is, at each instant the value of U depends only on the state of the system. This book will call a reference frame with this property a *local frame*. A local frame may also be, but is not necessarily, an earth-fixed lab frame.

Here is a simple illustration of the distinction between the energy E_{sys} of a system measured in a lab frame and the internal energy U measured in a local frame. Let the *system* be a fixed amount of water of uniform temperature T and pressure p contained in a glass beaker. (The glass material of the beaker is part of the surroundings.) The state of this system is defined by the independent variables T and p . The most convenient local frame in which to measure U in this case is a frame fixed with respect to the beaker.

- When the beaker is at rest on the lab bench, the local frame is a lab frame; then the energies E_{sys} and U are equal and depend only on T and p .
- If we place the beaker on a laboratory hot plate and use the hot plate to raise the temperature of the water, the values of E_{sys} and U increase equally.
- Suppose we slide the beaker horizontally along the lab bench while T and p stay constant. While the system is in motion, its kinetic energy is greater in the lab frame than in the local frame. Now E_{sys} is greater than when the beaker was at rest, although the state of the system and the value of U are unchanged.
- If we slowly lift the beaker above the bench, the potential energy of the water in the earth's gravitational field increases, again with no change in T and p . The value of E_{sys} has increased, but there has been no change in the state of the system or the value of U .

Section 3.1.1 will show that the relation between changes of the system energy and the internal energy in this example is $\Delta E_{\text{sys}} = \Delta E_{\text{k}} + \Delta E_{\text{p}} + \Delta U$, where E_{k} and E_{p} are the kinetic and potential energies of the system as a whole measured in the lab frame.

Our choice of the local frame used to define the internal energy U of any particular system during a given process is to some extent arbitrary. Three possible choices are as follows.

- If the system as a whole does not move or rotate in the laboratory, a lab frame is an appropriate local frame. Then U is the same as the system energy E_{sys} measured in the lab frame.
- If the system's center of mass moves in the lab frame during the process, we can let the local frame be a *center-of-mass frame* whose origin moves with the center of mass and whose Cartesian axes are parallel to the axes of the lab frame.
- If the system consists of the contents of a rigid container that moves or rotates in the lab, as in the illustration above, it may be convenient to choose a local frame that has its origin and axes fixed with respect to the container.

Is it possible to determine a numerical *value* for the internal energy of a system? The total energy of a body of mass m when it is at rest is given by the Einstein relation $E = mc^2$, where c is the speed of light in vacuum. In principle, then, we could calculate the internal energy U of a system at rest from its mass, and we could determine ΔU for a process from the change in mass. In practice, however, an absolute value of U calculated from a measured mass has too much uncertainty to be of any practical use. For example, the typical uncertainty of the mass of an object measured with a microbalance, about $0.1 \mu\text{g}$ (Table 2.2), would introduce the enormous uncertainty in energy of about 10^{10} joules. Only values of the *change* ΔU are useful, and these values cannot be calculated from Δm because the change in mass during an ordinary chemical process is much too small to be detected.

PROBLEMS

- 2.1** Let X represent the quantity V^2 with dimensions (length)⁶. Give a reason that X is or is not an extensive property. Give a reason that X is or is not an intensive property.
- 2.2** Calculate the *relative uncertainty* (the uncertainty divided by the value) for each of the measurement methods listed in Table 2.2 on page 38, using the typical values shown. For each of the five physical quantities listed, which measurement method has the smallest relative uncertainty?
- 2.3** Table 2.5 lists data obtained from a constant-volume gas thermometer containing samples of

Table 2.5 Helium at a fixed temperature

$(1/V_m)/10^2 \text{ mol m}^{-3}$	$(p_2 V_m/R)/K$
1.0225	2.7106
1.3202	2.6994
1.5829	2.6898
1.9042	2.6781
2.4572	2.6580
2.8180	2.6447
3.4160	2.6228
3.6016	2.6162
4.1375	2.5965
4.6115	2.5790
5.1717	2.5586

varying amounts of helium maintained at a certain fixed temperature T_2 in the gas bulb.²⁰ The molar volume V_m of each sample was evaluated from its pressure in the bulb at a reference temperature of $T_1 = 7.1992 \text{ K}$, corrected for gas nonideality with the known value of the second virial coefficient at that temperature.

Use these data and Eq. 2.2.2 on page 34 to evaluate T_2 and the second virial coefficient of helium at temperature T_2 . (You can assume the third and higher virial coefficients are negligible.)

- 2.4** Discuss the proposition that, to a certain degree of approximation, a living organism is a steady-state system.
- 2.5** The value of ΔU for the formation of one mole of crystalline potassium iodide from its elements at 25°C and 1 bar is -327.9 kJ . Calculate Δm for this process. Comment on the feasibility of measuring this mass change.

²⁰Ref. [13].

CHAPTER 3

THE FIRST LAW

In science, a **law** is a statement or mathematical relation that concisely describes reproducible experimental observations. Classical thermodynamics is built on a foundation of three laws, none of which can be derived from principles that are any more fundamental. This chapter discusses theoretical aspects of the first law; gives examples of *reversible* and *irreversible* processes and the heat and work that occur in them; and introduces the extensive state function *heat capacity*.

3.1 Heat, Work, and the First Law

The box below gives two forms of the **first law of thermodynamics**.

In a closed system:

$$dU = \delta q + \delta w \quad \Delta U = q + w$$

where U is the internal energy of the system, a state function;

q is heat; and

w is thermodynamic work.

The equation $dU = \delta q + \delta w$ is the *differential* form of the first law, and $\Delta U = q + w$ is the *integrated* form.

The heat and work appearing in the first law are two different modes of energy transfer. They can be defined in a general way as follows:

Heat refers to the transfer of energy across the boundary caused by a temperature gradient at the boundary.

Work refers to the transfer of energy across the boundary caused by the displacement of a macroscopic portion of the system on which the surroundings exert a force, or because of other kinds of concerted, directed movement of entities (e.g., electrons) on which an external force is exerted.

An infinitesimal quantity of energy transferred as heat at a surface element of the boundary is written δq , and a finite quantity is written q (Sec. 2.5). To obtain the total finite heat for a process from $q = \int \delta q$ (Eq. 2.5.3), we must integrate over the total boundary surface and the entire path of the process.

An infinitesimal quantity of work is δw , and a finite quantity is $w = \int \delta w$. To obtain w for a process, we integrate all kinds of work over the entire path of the process.

Any of these quantities for heat and work is *positive* if the effect is to *increase* the internal energy, and *negative* if the effect is to *decrease* it. Thus, positive heat is energy entering the system, and negative heat is energy leaving the system. Positive work is work done by the surroundings on the system, and negative work is work done by the system on the surroundings.

The first-law equation $\Delta U = q + w$ sets up a balance sheet for the energy of the system, measured in the local frame, by equating its change during a process to the net quantity of energy transferred by means of heat and work. Note that the equation applies only to a *closed* system. If the system is open, energy can also be brought across the boundary by the transport of matter.

An important part of the first law is the idea that heat and work are *quantitative* energy transfers. That is, when a certain quantity of energy enters the system in the form of heat, the same quantity leaves the surroundings. When the surroundings perform work on the system, the increase in the energy of the system is equal in magnitude to the decrease in the energy of the surroundings. The principle of conservation of energy is obeyed: the total energy (the sum of the energies of the system and surroundings) remains constant over time.¹

Heat transfer may occur by conduction, convection, or radiation.² We can reduce conduction with good thermal insulation at the boundary, we can eliminate conduction and convection with a vacuum gap, and we can minimize radiation with highly reflective surfaces at both sides of the vacuum gap. The only way to completely prevent heat during a process is to arrange conditions in the surroundings so there is no temperature gradient at any part of the boundary. Under these conditions the process is adiabatic, and any energy transfer in a closed system is then solely by means of work.

3.1.1 The concept of thermodynamic work

Appendix G gives a detailed analysis of energy and work based on the behavior of a collection of interacting particles moving according to the principles of classical mechanics. The analysis shows how we should evaluate mechanical thermodynamic work. Suppose the displacement responsible for the work comes from linear motion of a portion of the boundary in the $+x$ or $-x$ direction of the local frame. The differential and integrated forms of the work are then given by³

$$\delta w = F_x^{\text{sur}} dx \quad w = \int_{x_1}^{x_2} F_x^{\text{sur}} dx \quad (3.1.1)$$

Here F_x^{sur} is the component in the $+x$ direction of the force exerted by the surroundings on the system at the moving portion of the boundary, and dx is the infinitesimal displacement of the boundary in the local frame. If the displacement is in the same direction as the force, δw is positive; if the displacement is in the opposite direction, δw is negative.

¹Strictly speaking, it is the sum of the energies of the system, the surroundings, and any potential energy shared by both that is constant. The shared potential energy is usually negligible or essentially constant (Sec. G.5).

²Some thermodynamicists treat radiation as a separate contribution to ΔU , in addition to q and w .

³These equations are Eq. G.6.11 with a change of notation.

The kind of force represented by F_x^{sur} is a short-range contact force. Appendix G shows that the force exerted by a conservative time-independent external field, such as a gravitational force, should not be included as part of F_x^{sur} . This is because the work done by this kind of force causes changes of potential and kinetic energies that are equal and opposite in sign, with no net effect on the internal energy (see Sec. 3.6).

Newton's third law of action and reaction says that a force exerted by the surroundings on the system is opposed by a force of equal magnitude exerted in the opposite direction by the system on the surroundings. Thus the expressions in Eq. 3.1.1 can be replaced by

$$\delta w = -F_x^{\text{sys}} dx \quad w = - \int_{x_1}^{x_2} F_x^{\text{sys}} dx \quad (3.1.2)$$

where F_x^{sys} is the component in the $+x$ direction of the contact force exerted by the *system* on the surroundings at the moving portion of the boundary.

An alternative to using the expressions in Eqs. 3.1.1 or 3.1.2 for evaluating w is to imagine that the only effect of the work on the system's surroundings is a change in the elevation of a weight in the surroundings. The weight must be one that is linked mechanically to the source of the force F_x^{sur} . Then, provided the local frame is a stationary lab frame, the work is equal in magnitude and opposite in sign to the change in the weight's potential energy: $w = -mg\Delta h$ where m is the weight's mass, g is the acceleration of free fall, and h is the weight's elevation in the lab frame. This interpretation of work can be helpful for seeing whether work occurs and for deciding on its sign, but of course cannot be used to determine its *value* if the actual surroundings include no such weight.

The procedure of evaluating w from the change of an external weight's potential energy requires that this change be the only mechanical effect of the process on the surroundings, a condition that in practice is met only approximately. For example, Joule's paddle-wheel experiment using two weights linked to the system by strings and pulleys, described latter in Sec. 3.7.2, required corrections for (1) the kinetic energy gained by the weights as they sank, (2) friction in the pulley bearings, and (3) elasticity of the strings (see Prob. 3.10 on page 103).

In the first-law relation $\Delta U = q + w$, the quantities ΔU , q , and w are all measured in an arbitrary *local* frame. We can write an analogous relation for measurements in a stationary *lab* frame:

$$\Delta E_{\text{sys}} = q_{\text{lab}} + w_{\text{lab}} \quad (3.1.3)$$

Suppose the chosen local frame is not a lab frame, and we find it more convenient to measure the heat q_{lab} and the work w_{lab} in a lab frame than to measure q and w in the local frame. What corrections are needed to find q and w in this case?

If the Cartesian axes of the local frame do not rotate relative to the lab frame, then the heat is the same in both frames: $q = q_{\text{lab}}$.⁴

The expressions for δw_{lab} and w_{lab} are the same as those for δw and w in Eqs. 3.1.1 and 3.1.2, with dx interpreted as the displacement in the *lab* frame. There is an especially simple relation between w and w_{lab} when the local frame is a center-of-mass frame—one whose origin moves with the system's center of mass and whose axes do not rotate relative to the lab frame:⁵

$$w = w_{\text{lab}} - \frac{1}{2}m\Delta(v_{\text{cm}}^2) - mg\Delta z_{\text{cm}} \quad (3.1.4)$$

⁴Sec. G.7. ⁵Eq. G.8.12 on page 502.

In this equation m is the mass of the system, v_{cm} is the velocity of its center of mass in the lab frame, g is the acceleration of free fall, and z_{cm} is the height of the center of mass above an arbitrary zero of elevation in the lab frame. In typical thermodynamic processes the quantities v_{cm} and z_{cm} change to only a negligible extent, if at all, so that usually to a good approximation w is equal to w_{lab} .

When the local frame is a center-of-mass frame, we can combine the relations $\Delta U = q + w$ and $q = q_{\text{lab}}$ with Eqs. 3.1.3 and 3.1.4 to obtain

$$\Delta E_{\text{sys}} = \Delta E_{\text{k}} + \Delta E_{\text{p}} + \Delta U \quad (3.1.5)$$

where $E_{\text{k}} = \frac{1}{2}mv_{\text{cm}}^2$ and $E_{\text{p}} = mgz_{\text{cm}}$ are the kinetic and potential energies of the system as a whole in the lab frame.

A more general relation for w can be written for any local frame that has no rotational motion and whose origin has negligible acceleration in the lab frame:⁶

$$w = w_{\text{lab}} - mg\Delta z_{\text{loc}} \quad (3.1.6)$$

Here z_{loc} is the elevation in the lab frame of the origin of the local frame. Δz_{loc} is usually small or zero, so again w is approximately equal to w_{lab} . The only kinds of processes for which we may need to use Eq. 3.1.4 or 3.1.6 to calculate a non-negligible difference between w and w_{lab} are those in which massive parts of the system undergo substantial changes in elevation in the lab frame.

Simple relations such as these between q and q_{lab} , and between w and w_{lab} , do not exist if the local frame has rotational motion relative to a lab frame.

Hereafter in this book, thermodynamic work w will be called simply *work*. For all practical purposes you can assume the local frames for most of the processes to be described are stationary lab frames. The discussion above shows that the values of heat and work measured in these frames are usually the same, or practically the same, as if they were measured in a local frame moving with the system's center of mass. A notable exception is the local frame needed to treat the thermodynamic properties of a liquid solution in a centrifuge cell. In this case the local frame is fixed in the spinning rotor of the centrifuge and has rotational motion. This special case will be discussed in Sec. 9.8.2.

3.1.2 Work coefficients and work coordinates

If a process has only one kind of work, it can be expressed in the form

$$\delta w = Y dX \quad \text{or} \quad w = \int_{X_1}^{X_2} Y dX \quad (3.1.7)$$

where Y is a generalized force called a **work coefficient** and X is a generalized displacement called a **work coordinate**. The work coefficient and work coordinate are *conjugate* variables. They are not necessarily actual forces and displacements. For example, we shall see in Sec. 3.4.2 that reversible expansion work is given by $\delta w = -p dV$; in this case, the work coefficient is $-p$ and the work coordinate is V .

⁶Eq. G.7.3 on page 500.

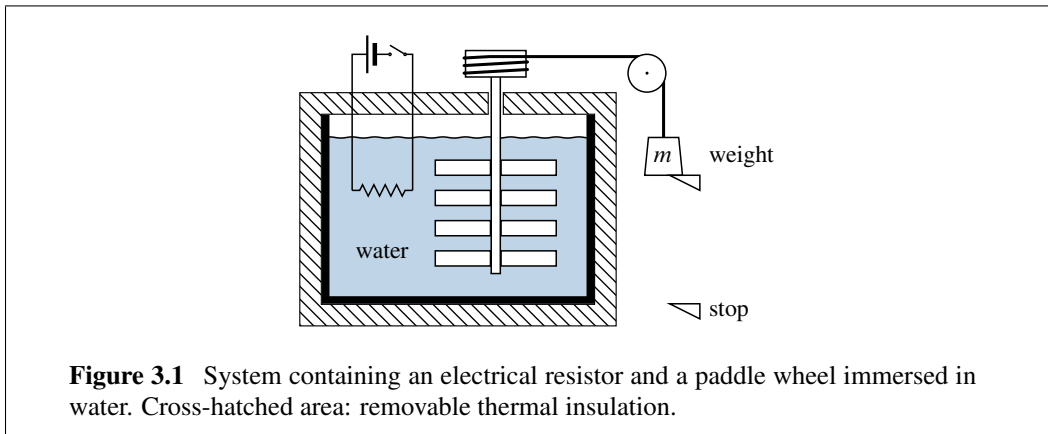

Figure 3.1 System containing an electrical resistor and a paddle wheel immersed in water. Cross-hatched area: removable thermal insulation.

A process may have more than one kind of work, each with its own work coefficient and conjugate work coordinate. In this case the work can be expressed as a sum over the different kinds labeled by the index i :

$$\delta w = \sum_i Y_i dX_i \quad \text{or} \quad w = \sum_i \int_{X_{i,1}}^{X_{i,2}} Y_i dX_i \quad (3.1.8)$$

3.1.3 Heat and work as path functions

Consider the apparatus shown in Fig. 3.1. The *system* consists of the water together with the immersed parts: stirring paddles attached to a shaft (a paddle wheel) and an electrical resistor attached to wires. In equilibrium states of this system, the paddle wheel is stationary and the temperature and pressure are uniform. The system is open to the atmosphere, so the pressure is constrained to be constant. We may describe the equilibrium states of this system by a single independent variable, the temperature T . (The angular position of the shaft is irrelevant to the state and is not a state function for equilibrium states of this system.)

Here are three experiments with different processes. Each process has the same initial state defined by $T_1 = 300.0$ K, and each has the same final state.

Experiment 1: We surround the system with thermal insulation as shown in the figure and release the external weight, which is linked mechanically to the paddle wheel. The resulting paddle-wheel rotation causes turbulent churning of the water and an increase in its temperature. Assume that after the weight hits the stop and the paddle wheel comes to rest, the final angular position of the paddle wheel is the same as at the beginning of the experiment. We can calculate the work done on the system from the difference between the potential energy lost by the weight and the kinetic energy gained before it reaches the stop.⁷ We wait until the water comes to rest and the system comes to thermal equilibrium, then measure the final temperature. Assume the final temperature is $T_2 = 300.10$ K, an increase of 0.10 kelvins.

Experiment 2: We start with the system in the same initial state as in experiment 1, and again surround it with thermal insulation. This time, instead of releasing the weight we

⁷This calculation is an example of the procedure mentioned on page 59 in which the change in elevation of an external weight is used to evaluate work.

close the switch to complete an electrical circuit with the resistor and allow the same quantity of electrical work to be done on the system as the mechanical work done in experiment 1. We discover the final temperature (300.10 K) is exactly the same as at the end of experiment 1. The process and path are different from those in experiment 1, but the work and the initial and final states are the same.

Experiment 3: We return the system to its initial state, remove the thermal insulation, and place the system in thermal contact with a heat reservoir of temperature 300.10 K. Energy can now enter the system in the form of heat, and does so because of the temperature gradient at the boundary. By a substitution of heat for mechanical or electrical work, the system changes to the same final state as in experiments 1 and 2.

Although the paths in the three experiments are entirely different, the overall change of state is the same. In fact, a person who observes only the initial and final states and has no knowledge of the intermediate states or the changes in the surroundings will be ignorant of the path. Did the paddle wheel turn? Did an electric current pass through the resistor? How much energy was transferred by work and how much by heat? The observer cannot tell from the change of state, because heat and work are not state functions. The change of state depends on the *sum* of heat and work. This sum is the change in the state function U , as expressed by the integrated form of the first law, $\Delta U = q + w$.

It follows from this discussion that neither heat nor work are quantities possessed by the system. A system at a given instant does not *have* or *contain* a particular quantity of heat or a particular quantity of work. Instead, heat and work depend on the path of a process occurring over a period of time. They are *path* functions.

3.1.4 Heat and heating

In thermodynamics, the technical meaning of the word “heat” when used as a noun is *energy transferred across the boundary because of a temperature gradient at the boundary*.

In everyday speech the noun *heat* is often used somewhat differently. Here are three statements with similar meanings that could be misleading:

“Heat is transferred from a laboratory hot plate to a beaker of water.”

“Heat flows from a warmer body to a cooler body.”

“To remove heat from a hot body, place it in cold water.”

Statements such as these may give the false impression that heat is like a substance that retains its identity as it moves from one body to another. Actually heat, like work, does not exist as an entity once a process is completed. Nevertheless, the wording of statements such as these is embedded in our everyday language, and no harm is done if we interpret them correctly. This book, for conciseness, often refers to “heat transfer” and “heat flow,” instead of using the technically more correct phrase “energy transfer by means of heat.”

Another common problem is failure to distinguish between thermodynamic “heat” and the process of “heating.” To *heat* a system is to cause its temperature to increase. A *heated* system is one that has become warmer. This process of *heating* does not necessarily involve thermodynamic heat; it can also be carried out with work as illustrated by experiments 1 and 2 of the preceding section.

The notion of heat as an indestructible substance was the essence of the caloric theory. This theory was finally disproved by the cannon-boring experiments of Benjamin Thompson (Count Rumford) in the late eighteenth century, and in a more quantitative

way by the measurement of the mechanical equivalent of heat by James Joule in the 1840s (see Sec. 3.7.2).

3.1.5 Heat capacity

The **heat capacity** of a closed system is defined as the ratio of an infinitesimal quantity of heat transferred across the boundary under specified conditions and the resulting infinitesimal temperature change:

$$\text{heat capacity} \stackrel{\text{def}}{=} \frac{\mathrm{d}q}{\mathrm{d}T} \quad (3.1.9)$$

(closed system)

Since q is a path function, the value of the heat capacity depends on the specified conditions, usually either constant volume or constant pressure. C_V is the *heat capacity at constant volume* and C_p is the *heat capacity at constant pressure*. These are extensive state functions that will be discussed more fully in Sec. 5.6.

3.1.6 Thermal energy

It is sometimes useful to use the concept of **thermal energy**. It can be defined as the kinetic energy of random translational motions of atoms and molecules relative to the local frame, plus the vibrational and rotational energies of molecules. The thermal energy of a body or phase depends on its temperature, and increases when the temperature increases. The thermal energy of a system is a contribution to the internal energy.

It is important to understand that a change of the system's thermal energy during a process is not necessarily the same as energy transferred across the system boundary as heat. The two quantities are equal only if the system is closed and there is no work, volume change, phase change, or chemical reaction. This is illustrated by the three experiments described in Sec. 3.1.3: the thermal energy change is the same in each experiment, but only in experiment 3 is the work negligible and the thermal energy change equal to the heat.

3.2 Spontaneous, Reversible, and Irreversible Processes

A **spontaneous process** is a process that can actually occur in a finite time period under the existing conditions. Any change over time in the state of a system that we observe experimentally is a spontaneous process.

A spontaneous process is sometimes called a natural process, feasible process, possible process, allowed process, or real process.

3.2.1 Reversible processes

A **reversible process** is an important concept in thermodynamics. This concept is needed for the chain of reasoning in the next chapter by which the existence of entropy as a state function is derived and its changes defined. The existence of entropy then leads on to the establishment of criteria for spontaneity and for various kinds of equilibria. Innumerable useful relations (equalities) among heat, work, and state functions such as Gibbs energy can be obtained for processes that are carried out reversibly.

BIOGRAPHICAL SKETCH

Benjamin Thompson, Count of Rumford (1753–1814)

Benjamin Thompson, whose career was remarkably varied and colorful, collected experimental evidence of the falseness of the caloric theory—the concept that heat is a material substance. He was a complex man: energetic, egotistical, domineering, and misanthropic.

Thompson was born into a farming family in Woburn, Massachusetts. He married a wealthy widow and was admitted into fashionable society. At the time of the American Revolution he was accused of being a loyalist, and at the age of 23 fled to England, abandoning his wife and daughter. He was an Under Secretary of State in London, returned briefly to America as a British cavalry commander, and then spent 11 years as a colonel in the Bavarian army. In Bavaria, to reward his success in reorganizing the army and reforming the social welfare system, he was made a Count of the Holy Roman Empire. He chose the name Rumford after the original name of Concord, New Hampshire, his wife's home town.

While in Bavaria, Count Rumford carried out the cannon-boring experiments for which he is best known. The caloric theory held that heat is a kind of indestructible fluid (“caloric”) that is held in the spaces between the atoms of a body. Frictional forces were supposed to cause a rise in temperature by squeezing caloric fluid out of a body. Rumford's experiments involved boring into a horizontally-fixed cannon barrel with a blunt steel bit turned by horse power. He reported the results in 1798:^a

^aRef. [156].

Being engaged, lately in superintending the boring of cannon, in the workshops of the military arsenal at Munich, I was struck with the very considerable degree of heat which a brass gun acquires, in a short time, in being bored; and with the still more intense heat (much greater than that of boiling water, as I found by experiment,) of the metallic chips separated from it by the borer. . .

By meditating on the results of all these experiments, we are naturally brought to that great question which has so often been the subject of speculation among philosophers; namely,

What is Heat?—Is there any such thing as an *igneous fluid*?—Is there any thing that can with propriety be called *caloric*? . . .

And, in reasoning on this subject, we must not forget to consider that most remarkable circumstance, that the source of the heat generated by friction, in these experiments, appeared evidently to be *inexhaustible*.

It is hardly necessary to add, that any thing which any *insulated* body, or system of bodies, can continue to furnish *without limitation*, cannot possibly be a *material substance*: and it appears to me to be extremely difficult, if not quite impossible, to form any distinct idea of any thing, capable of being excited and communicated, in the manner the heat was excited and communicated in these experiments, except it be MOTION.

Rumford thought of heat in a solid as harmonic vibrations similar to acoustic waves, not as random motion or as a form of energy as later developed by James Joule.

Rumford also made investigations into ballistics, nutrition, thermometry, light, and fabric properties. He invented the Rumford fireplace and the drip coffee percolator. After living in London for fourteen years, he settled in Paris in 1804. The following year, his first wife having died in America, he married the widow of the famous French chemist Antoine Lavoisier. The marriage was stormy and they soon separated.

Before reversible processes can be discussed, it is necessary to explain the meaning of the *reverse* of a process. If a particular process takes the system from an initial state A through a continuous sequence of intermediate states to a final state B, then the reverse of this process is a change over time from state B to state A with the same intermediate states occurring in the reverse time sequence. To visualize the reverse of any process, imagine making a movie film of the events of the process. Each frame of the film is a “snapshot” picture of the state at one instant. If you run the film backward through a movie projector, you see the reverse process: the values of system properties such as p and V appear to change in reverse chronological order, and each velocity changes sign.

If a process is spontaneous, which implies its reverse cannot be observed experimentally, the process is *irreversible*.

The concept of a reversible process is not easy to describe or to grasp. Perhaps the most confusing aspect is that a reversible process is not a process that ever actually occurs, but is only approached as a hypothetical limit.

During a reversible process the system passes through a continuous sequence of equilibrium states. These states are ones that can be approached, as closely as desired, by the states of a spontaneous process carried out sufficiently slowly. The slower the process is, the more time there is between two successive intermediate states for equilibrium to be approached. As the spontaneous process is carried out more and more slowly, it approaches the reversible limit. Thus, a reversible process is an *idealized* process with a sequence of equilibrium states that are those of a spontaneous process in the *limit* of infinite slowness.

Fermi⁸ describes a reversible process as follows: “A transformation is said to be *reversible* when the successive states of the transformation differ by infinitesimals from *equilibrium states*. A reversible transformation can therefore connect only those initial and final states which are states of equilibrium. A reversible transformation can be realized in practice by changing the external conditions so slowly that the system has time to adjust itself gradually to the altered conditions.”

This book has many equations expressing relations among heat, work, and state functions during various kinds of reversible processes. What is the use of an equation for a process that can never actually occur? The point is that the equation can describe a spontaneous process to a high degree of accuracy, if the process is carried out slowly enough for the intermediate states to depart only slightly from exact equilibrium states. For example, for many important spontaneous processes we can assume the temperature and pressure are uniform throughout the system, although this is only an approximation.

A reversible process of a closed system, as used in this book, has all of the following characteristics:

- It is an imaginary, idealized process in which the system passes through a continuous sequence of equilibrium states. That is, the state at each instant is one that in an isolated system would persist with no tendency to change over time. (This kind of process is sometimes called a *quasistatic* process.)
- The sequence of equilibrium states can be approximated, as closely as desired, by the intermediate states of a real spontaneous process carried out sufficiently slowly. The reverse sequence of equilibrium states can also be approximated, as closely as

⁸Ref. [58], page 4.

desired, by the intermediate states of another spontaneous process carried out sufficiently slowly. (This requirement prevents any spontaneous process with hysteresis, such as plastic deformation or the stretching of a metal wire beyond its elastic limit, from having a reversible limit.) During the approach to infinite slowness, very slow changes of the type described in item 3 on page 50 must be eliminated, i.e., prevented with hypothetical constraints.

- The spontaneous process of a closed system that has a reversible limit must be a process with heat, or work, or both—the system cannot be an isolated one. It must be possible for an experimenter to use conditions in the surroundings to control the rate at which energy is transferred across the boundary by means of heat and work, and thus to make the process go as slowly as desired.
- If energy is transferred by work during a reversible process, the work coefficient Y in the expression $\delta w = Y dX$ must be finite (nonzero) in equilibrium states of the system. For example, if the work is given by $\delta w = -F_x^{\text{sys}} dx$ (Eq. 3.1.2), the force F_x^{sys} exerted by the system on the surroundings must be present when the system is in an equilibrium state.
- In the reversible limit, any energy dissipation within the system, such as that due to internal friction, vanishes. Internal energy dissipation is the situation in which energy transferred to the system by positive work is not fully recovered in the surroundings when the sign of the work coordinate change dX is reversed.
- When any infinitesimal step of a reversible process takes place in reverse, the magnitudes of the heat δq and work δw are unchanged and their signs are reversed. Thus, energy transferred as heat in one direction across the boundary during a reversible process is transferred as heat in the opposite direction during the reverse process. The same is true for the energy transferred as work.

We must imagine the reversible process to proceed at a finite rate, otherwise there would be no change of state over time. The precise rate of the change is not important. Imagine a gas whose volume, temperature, and pressure are changing at some finite rate while the temperature and pressure magically stay perfectly uniform throughout the system. This is an entirely imaginary process, because there is no temperature or pressure gradient—no physical “driving force”—that would make the change tend to occur in a particular direction. This imaginary process is a reversible process—one whose states of uniform temperature and pressure are approached by the states of a real process as the real process takes place more and more slowly.

It is a good idea, whenever you see the word “reversible,” to think “in the reversible limit.” Thus a *reversible process* is a process in the reversible limit, *reversible work* is work in the reversible limit, and so on.

3.2.2 Reversibility and the surroundings

The reverse of a reversible process is itself a reversible process. As explained above, the quantities of energy transferred across the boundary as heat and work during a reversible process are returned across the boundary when the reversible process is followed by the reverse process.

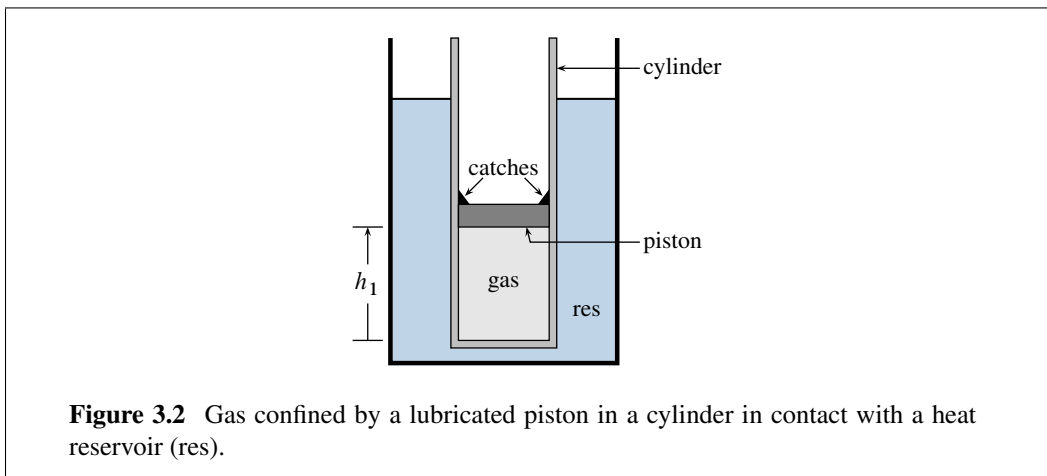

Some authors describe a reversible process as one that allows both the system and the surroundings to be restored to their initial states.⁹ The problem with this description is that during the time period in which the process and its reverse take place, spontaneous irreversible changes inevitably occur in the surroundings.

The textbook *Heat and Thermodynamics* by Zemansky and Dittman¹⁰ states that “a reversible process is one that is performed in such a way that, at the conclusion of the process, both the system and the local surroundings may be restored to their initial states without producing any changes in the rest of the universe.” The authors explain that by “local surroundings” they mean parts of the surroundings that interact directly with the system to transfer energy across the boundary, and that “the rest of the universe” consists of what they call “auxiliary surroundings” that *might* interact with the system.

They give as an example of local surroundings a weight whose lowering or raising causes work to be done on or by the system, and a series of heat reservoirs placed in thermal contact with the system to cause heat transfer. The auxiliary surroundings presumably include a way to lower or raise the weight and to move the heat reservoirs to and away from the system. The control of these external operations would require a human operator or some sort of automated mechanism whose actions would be spontaneous and irreversible. If these are considered to be part of the auxiliary surroundings, as it seems they should be, then it would in fact not be possible for all the auxiliary surroundings to return to their initial states as claimed.

The cylinder-and-piston device shown in Fig. 3.2 can be used to illustrate a reversible process whose reverse process does not restore the local surroundings. The *system* in this example is the confined gas. The local surroundings are the piston (a weight), and the heat reservoir of temperature T_{res} in thermal contact with the system. Initially, the gas pressure pushes the piston against the catches, which hold it in place at elevation h_1 . The gas is in an equilibrium state at temperature T_{res} , volume V_1 , and pressure p_1 . To begin the process, the catches are removed. The piston moves upwards and comes to rest at an elevation greater than h_1 . The gas has now changed to a new equilibrium state with temperature T_{res} , a

⁹For example, Ref. [114], page 73: “A process in which a system goes from state A to state B is defined to be (thermodynamically) reversible, if it is possible to restore the system to the state A without producing permanent changes of any kind anywhere else.”

¹⁰Ref. [186], page 158.

volume greater than V_1 , and a pressure less than p_1 .

The rate of this expansion process is influenced by sliding friction in the surroundings at the lubricated seal between the edge of the piston and the inner surface of the cylinder. Although the frictional drag force for a given lubricant viscosity approaches zero as the piston velocity decreases, model calculations¹¹ show that the greater is the viscosity, the slower is the expansion. Assume the lubricant has a high viscosity that slows the expansion enough to make the intermediate states differ only slightly from equilibrium states. In the limit of infinite slowness, the process would be a reversible isothermal expansion of the gas. The friction at the piston, needed for the approach to a reversible expansion, produces thermal energy that is transferred as heat to the heat reservoir.

To reverse the expansion process, a weight is placed on the piston, causing the piston to sink and eventually return to rest. Again friction at the piston causes heat transfer to the heat reservoir. The weight's mass is such that, after the gas has become equilibrated with the heat reservoir, the piston has returned to its initial elevation h_1 . The system has now returned to its initial state with $T = T_{\text{res}}$, $V = V_1$, and $p = p_1$. In the limit of infinite slowness, this process is a reversible isothermal compression that is the reverse of the reversible expansion.

Note that the local surroundings have not returned to their initial conditions: a weight has been added to the piston, and the heat reservoir's internal energy has increased due to the friction at the piston. It would be possible to restore these initial conditions, but the necessary operations would involve further irreversible changes in the auxiliary surroundings.

Based on the above, it is apparent that it is neither useful nor valid to describe a reversible process as one for which the surroundings can be restored. Instead, this book defines a reversible process by the characteristics listed on pages 65 and 66, involving only changes in the system itself, regardless of what happens in the surroundings. Such a process can be described as having *internal reversibility* and as being *internally reversible*.¹²

3.2.3 Irreversible processes

An **irreversible** process is a spontaneous process whose reverse is neither spontaneous nor reversible. That is, the reverse of an irreversible process can never actually occur and is *impossible*. If a movie is made of a spontaneous process, and the time sequence of the events depicted by the film when it is run backward could not occur in reality, the spontaneous process is irreversible.

A good example of a spontaneous, irreversible process is experiment 1 on page 61, in which the sinking of an external weight causes a paddle wheel immersed in water to rotate and the temperature of the water to increase. During this experiment mechanical energy is dissipated into thermal energy. Suppose you insert a thermometer in the water and make a movie film of the experiment. Then when you run the film backward in a projector, you will see the paddle wheel rotating in the direction that raises the weight, and the water becoming cooler according to the thermometer. Clearly, this reverse process is impossible in the real physical world, and the process occurring during the experiment is irreversible. It is not difficult to understand why it is irreversible when we consider events on the microscopic level: it is extremely unlikely that the H_2O molecules next to the paddles would happen to move simultaneously over a period of time in the concerted motion needed to raise the weight.

¹¹Ref. [46], Example 2.

¹²Ref. [81], Section 14.7; Ref. [164], page 182; Ref. [42], Section 5.4.

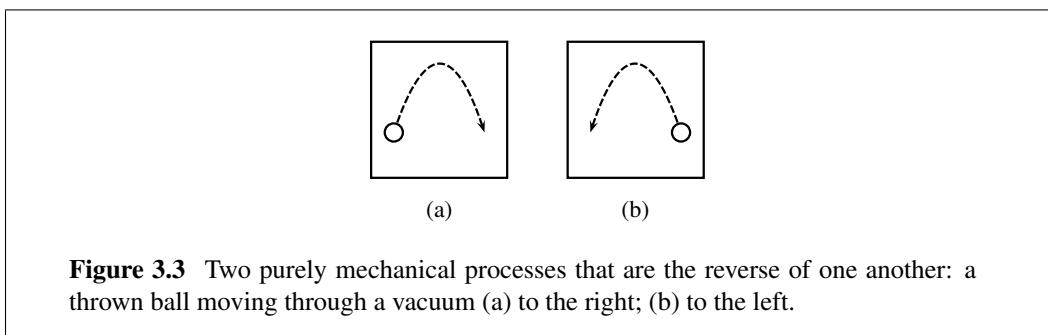

3.2.4 Purely mechanical processes

There is a class of spontaneous processes that are also spontaneous in reverse; that is, spontaneous but not irreversible. These are *purely mechanical* processes involving the motion of perfectly-elastic macroscopic bodies without friction, temperature gradients, viscous flow, or other irreversible changes.

A simple example of a purely mechanical process and its reverse is shown in Fig. 3.3. The ball can move spontaneously in either direction. Another example is a flywheel with frictionless bearings rotating in a vacuum.

A purely mechanical process proceeding at a finite rate is not reversible, for its states are not equilibrium states. Such a process is an idealization, of a different kind than a reversible process, and is of little interest in chemistry. Later chapters of this book will ignore such processes and will treat the terms *spontaneous* and *irreversible* as synonyms.

3.3 Heat Transfer

This section describes irreversible and reversible heat transfer. Keep in mind that when this book refers to *heat transfer* or *heat flow*, energy is being transferred across the boundary on account of a temperature gradient at the boundary. The transfer is always in the direction of decreasing temperature.

We may sometimes wish to treat the temperature as if it is discontinuous at the boundary, with different values on either side. The transfer of energy is then from the warmer side to the cooler side. The temperature is not actually discontinuous; instead there is a thin zone with a temperature gradient.

3.3.1 Heating and cooling

As an illustration of irreversible heat transfer, consider a system that is a solid metal sphere. This spherical body is immersed in a well-stirred water bath whose temperature we can control. The bath and the metal sphere are initially equilibrated at temperature $T_1 = 300.0$ K, and we wish to raise the temperature of the sphere by one kelvin to a final uniform temperature $T_2 = 301.0$ K.

One way to do this is to rapidly increase the external bath temperature to 301.0 K and keep it at that temperature. The temperature difference across the surface of the immersed sphere then causes a spontaneous flow of heat through the system boundary into the sphere. It takes time for all parts of the sphere to reach the higher temperature, so a temporary

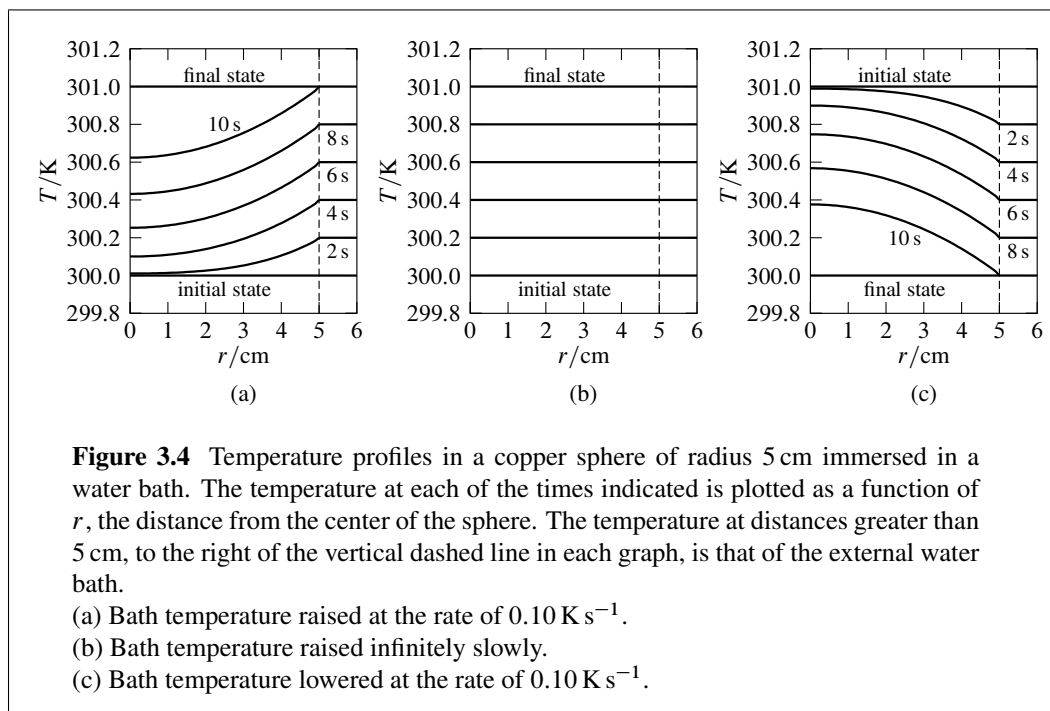

internal temperature gradient is established. Thermal energy flows spontaneously from the higher temperature at the boundary to the lower temperature in the interior. Eventually the temperature in the sphere becomes uniform and equal to the bath temperature of 301.0 K.

Figure 3.4(a) graphically depicts temperatures within the sphere at different times during the heating process. Note the temperature gradient in the intermediate states. Because of the gradient, these states cannot be characterized by a single value of the temperature. If we were to suddenly isolate the system (the sphere) with a thermally-insulated jacket while it is in one of these states, the state would change as the temperature gradient rapidly disappears. Thus, the intermediate states of the spontaneous heating process are not equilibrium states, and the rapid heating process is not reversible.

To make the intermediate states more nearly uniform in temperature, with smaller temperature gradients, we can raise the temperature of the bath at a slower rate. The sequence of states approached in the limit of infinite slowness is indicated in Fig. 3.4(b). In each intermediate state of this limiting sequence, the temperature is perfectly uniform throughout the sphere and is equal to the external bath temperature. That is, each state has thermal equilibrium both internally and with respect to the surroundings. A single temperature now suffices to define the state at each instant. Each state is an *equilibrium* state because it would have no tendency to change if we isolated the system with thermal insulation. This limiting sequence of states is a *reversible* heating process.

The reverse of the reversible heating process is a reversible cooling process in which the temperature is again uniform in each state. The sequence of states of this reverse process is the limit of the spontaneous cooling process depicted in Fig. 3.4(c) as we decrease the bath temperature more and more slowly.

In any real heating process occurring at a finite rate, the sphere's temperature could not be perfectly uniform in intermediate states. If we raise the bath temperature very slowly,

however, the temperature in all parts of the sphere will be very close to that of the bath. At any point in this very slow heating process, it would then take only a small decrease in the bath temperature to start a *cooling* process; that is, the practically-reversible heating process would be reversed.

The important thing to note about the temperature gradients shown in Fig. 3.4(c) for the spontaneous cooling process is that none resemble the gradients in Fig. 3.4(a) for the spontaneous heating process—the gradients are in opposite directions. It is physically impossible for the sequence of states of either process to occur in the reverse chronological order, for that would have thermal energy flowing in the wrong direction along the temperature gradient. These considerations show that a spontaneous heat transfer is irreversible. Only in the reversible limits do the heating and cooling processes have the same intermediate states; these states have no temperature gradients.

Although the spontaneous heating and cooling processes are irreversible, the energy transferred into the system during heating can be fully recovered as energy transferred back to the surroundings during cooling, provided there is no irreversible work. This recoverability of irreversible heat is in distinct contrast to the behavior of irreversible work.

3.3.2 Spontaneous phase transitions

Consider a different kind of system, one consisting of the liquid and solid phases of a pure substance. At a given pressure, this kind of system can be in transfer equilibrium at only one temperature: for example, water and ice at 1.01 bar and 273.15 K. Suppose the system is initially at this pressure and temperature. Heat transfer into the system will then cause a phase transition from solid to liquid (Sec. 2.2.2). We can carry out the heat transfer by placing the system in thermal contact with an external water bath at a higher temperature than the equilibrium temperature, which will cause a temperature gradient in the system and the melting of an amount of solid proportional to the quantity of energy transferred.

The closer the external temperature is to the equilibrium temperature, the smaller are the temperature gradients and the closer are the states of the system to equilibrium states. In the limit as the temperature difference approaches zero, the system passes through a sequence of equilibrium states in which the temperature is uniform and constant, energy is transferred into the system by heat, and the substance is transformed from solid to liquid. This idealized process is an *equilibrium* phase transition, and it is a reversible process.

3.4 Deformation Work

This and the four following sections (Secs. 3.5–3.8) describe some spontaneous, irreversible processes with various kinds of work and illustrate the concept of a reversible limit for the processes that have such a limit.

The *deformation* of a system involves changes in the position, relative to the local frame, of portions of the system boundary. At a small surface element τ of the boundary, the work of deformation is given in general by the expression¹³

$$\delta w_\tau = F_\tau^{\text{sur}} \cos \alpha_\tau ds_\tau \quad (3.4.1)$$

¹³From Eq. G.6.10 on page 499.

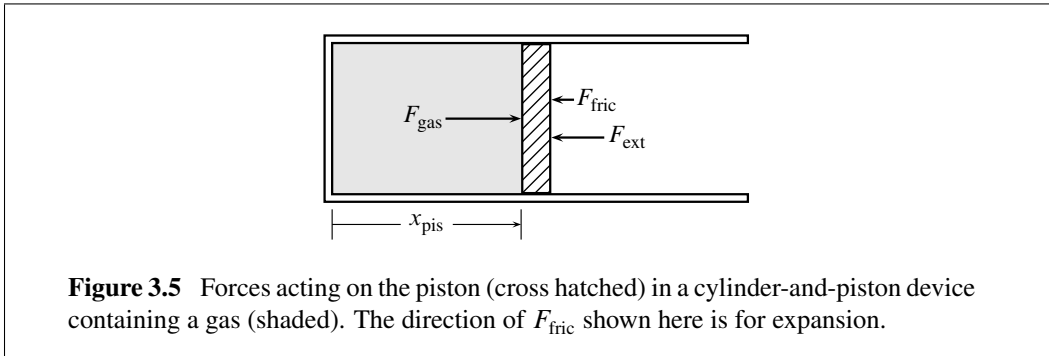

where F_{τ}^{sur} is the magnitude of the contact force exerted by the surroundings on the surface element, ds_{τ} is the infinitesimal displacement of the surface element in the local frame, and α_{τ} is the angle between the directions of the force and the displacement. If the displacement is entirely parallel to the x axis, the expression becomes equivalent to that already given by Eq. 3.1.1 on page 58: $\delta w = F_x^{\text{sur}} dx$.

3.4.1 Gas in a cylinder-and-piston device

A useful kind of deformation for the development of thermodynamic theory is a change in the volume of a gas or liquid.

As a model for the work involved in changing the volume of a gas, consider the arrangement shown in Fig. 3.5. A sample of gas is confined in a horizontal cylinder by a piston. The *system* is the gas. The piston is not part of the system, but its position given by the variable x_{pis} determines the system's volume. Movement of the piston to the right, in the $+x$ direction, expands the gas; movement to the left, in the $-x$ direction, compresses it.

We will find it instructive to look in detail at the forces acting on the piston. There are three kinds: the force F_{gas} exerted in the $+x$ direction by the gas; an external force F_{ext} in the $-x$ direction, which we can control in the surroundings; and a frictional force F_{fric} in the direction opposite to the piston's velocity when the piston moves.

The friction occurs at the seal between the edge of the piston and the cylinder wall. We will assume this seal is lubricated, and that F_{fric} approaches zero as the piston velocity approaches zero.

Let p_b be the average pressure of the gas *at the piston*—that is, at the moving portion of the system boundary (the subscript “b” stands for boundary). Then the force exerted by the gas on the piston is given by

$$F_{\text{gas}} = p_b A_s \quad (3.4.2)$$

where A_s is the cross-section area of the cylinder.

The component in the $+x$ direction of the net force F_{net} acting on the piston is given by

$$F_{\text{net}} = F_{\text{gas}} - F_{\text{ext}} + F_{\text{fric}} \quad (3.4.3)$$

Here, F_{gas} and F_{ext} are taken as positive. F_{fric} is negative when the piston moves to the right, positive when the piston moves to the left, and zero when the piston is stationary.

Suppose the system (the gas) initially is in an equilibrium state of uniform temperature T_1 and uniform pressure p_1 , and the piston is stationary, so that F_{fric} is zero. According to Newton's second law of motion, the net force F_{net} is also zero, because otherwise the piston

would be accelerating. Then, from Eqs. 3.4.2 and 3.4.3, the external force needed to keep the piston from moving is $F_{\text{ext}} = F_{\text{gas}} = p_1 A_s$.

To avoid complications of heat transfer, we confine our attention to a system with an adiabatic boundary. By reducing F_{ext} from its initial value of $p_1 A_s$, we cause spontaneous expansion to begin. As the piston moves to the right, the pressure p_b exerted on the left face of the piston becomes slightly *less* than the pressure on the stationary cylinder wall. The molecular explanation of this pressure gradient is that gas molecules moving to the right approach the moving piston at lower velocities relative to the piston than if the piston were stationary, so that they collide with the piston less frequently and with a smaller loss of momentum in each collision. The temperature and pressure within the gas become nonuniform, and we cannot describe intermediate states of this spontaneous process with single values of T and p . These intermediate states are not equilibrium states.

The more slowly we allow the adiabatic expansion to take place, the more nearly uniform are the temperature and pressure. In the limit of infinite slowness, the gas passes through a continuous sequence of equilibrium states of uniform temperature and pressure.

Let p_2 be the pressure in the final state of the infinitely-slow expansion. In this state, F_{ext} is equal to $p_2 A_s$. By *increasing* F_{ext} from this value, we cause spontaneous compression to begin. The gas pressure p_b at the piston now becomes slightly *greater* than at the stationary cylinder wall, because the piston is moving to the left toward the molecules that are moving to the right. A different pressure gradient develops than during expansion. The states approached in the limit as we carry out the compression more and more slowly are equilibrium states, occurring in the reverse sequence of the states for expansion at infinite slowness. The sequence of equilibrium states, taken in either direction, is a *reversible* process.

The magnitude of the effect of piston velocity on p_b can be estimated with the help of the kinetic-molecular theory of gases. This theory, of course, is not part of classical macroscopic thermodynamics.

Consider the collision of a gas molecule of mass m with the left face of the piston shown in Fig. 3.5. Assume the piston moves at a constant velocity $u = dx_{\text{pis}}/dt$, positive for expansion of the gas and negative for compression.

Let x be the horizontal distance of the molecule from the left end of the cylinder, and v_x be the component of its velocity in the $+x$ direction measured in the cylinder-fixed lab frame: $v_x = dx/dt$. Let v'_x be the component of its velocity in the $+x$ direction measured in a reference frame moving with the piston: $v'_x = v_x - u$.

In one cycle of the molecule's motion, the molecule starts at the left end of the cylinder at time t_1 , moves to the right with velocity $v_{x,1} > 0$, collides with and is reflected from the piston face, moves to the left with velocity $v_{x,2} < 0$, and finally collides with the left end at time t_2 . In the piston-fixed frame, the collision with the piston changes the sign but not the magnitude of v'_x : $v'_{x,2} = -v'_{x,1}$. Consequently, the relation between the velocity components in the lab frame after and before the collision with the piston is

$$\begin{aligned} v_{x,2} - u &= -(v_{x,1} - u) \\ v_{x,2} &= -v_{x,1} + 2u \end{aligned} \quad (3.4.4)$$

At each instant during the collision itself, the interaction of the piston face with the gas molecule changes v_x . From Newton's second law, the force exerted on the molecule equals its mass times its acceleration. From Newton's third law, the force F_x exerted by the molecule on the piston has the same magnitude and opposite sign of

the force exerted on the molecule: $F_x = -m dv_x/dt$. F_x is zero at times before and after the collision. Rearrangement to $F_x dt = -m dv_x$ and integration over the time interval of the cycle yields

$$\int_{t_1}^{t_2} F_x dt = -m \int_{t_1}^{t_2} dv_x = -m(v_{x,2} - v_{x,1}) \quad (3.4.5)$$

Then from the relation of Eq. 3.4.4, $\int_{t_1}^{t_2} F_x dt$ equals $2m(v_{x,1} - u)$.

The time average $\langle F_x \rangle$ of F_x over the interval of the cycle is

$$\langle F_x \rangle = \frac{1}{(t_2 - t_1)} \int_{t_1}^{t_2} F_x dt = \frac{2m(v_{x,1} - u)}{(t_2 - t_1)} \quad (3.4.6)$$

An expression for $t_2 - t_1$ as a function of $v_{x,1}$ and u can be derived using $\Delta t = \Delta x/v_x$:

$$t_2 - t_1 = \frac{l}{v_{x,1}} + \frac{-l}{v_{x,2}} = \frac{l}{v_{x,1}} + \frac{-l}{-v_{x,1} + 2u} = \frac{2l(v_{x,1} - u)}{v_{x,1}^2 - 2uv_{x,1}} \quad (3.4.7)$$

Here l is the interior length of the cylinder at the time the molecule collides with the piston.

From Eqs. 3.4.6 and 3.4.7, the time average during the cycle of the force exerted by the gas molecule on the piston is

$$\langle F_x \rangle = \frac{2m(v_{x,1} - u)(v_{x,1}^2 - 2uv_{x,1})}{2l(v_{x,1} - u)} = \frac{m}{l}(v_{x,1}^2 - 2uv_{x,1}) \quad (3.4.8)$$

The gas consists of nM/m molecules, where n is the amount and M is the molar mass. There is a range of values of $v_{x,1}$. The total pressure p_b exerted by the gas on the piston is found by summing $\langle F_x \rangle$ over all molecules and dividing by the piston area A_s :

$$p_b = \left(\frac{1}{A_s}\right) \left(\frac{nM}{m}\right) \left(\frac{m}{l}\right) (\langle v_{x,1}^2 \rangle - 2u \langle v_{x,1} \rangle) \quad (3.4.9)$$

The pressure p at the stationary cylinder wall is found by setting u equal to zero in the expression for p_b . Thus p_b is related to p by¹⁴

$$p_b = p \left(1 - 2u \frac{\langle v_{x,1} \rangle}{\langle v_{x,1}^2 \rangle}\right) \quad (3.4.10)$$

From kinetic-molecular theory, the averages are given by $\langle v_{x,1} \rangle = (2RT/\pi M)^{1/2}$ and $\langle v_{x,1}^2 \rangle = RT/M$. Suppose the piston moves at the considerable speed of 10 m s^{-1} and the gas in the cylinder is nitrogen (N_2) at 300 K ; then Eq. 3.4.10 predicts the pressure p_b exerted on the piston by the gas during expansion is only about 5% lower than the pressure p at the stationary wall, and during compression about 5% higher. At low piston speeds the percentage difference is proportional to the piston speed, so this example shows that for reasonably slow speeds the difference is quite small and for practical calculations can usually be ignored.

¹⁴A formula similar to this to the first order in u is given in Ref. [14]. A formula that yields similar values of p_b appears in Ref. [9], Eq. 7.

3.4.2 Expansion work of a gas

We now consider the work involved in expansion and compression of the gas in the cylinder-and-piston device of Fig. 3.5. This kind of deformation work, for both expansion and compression, is called **expansion work** or pressure-volume work.

Keep in mind that the *system* is just the gas. The only moving portion of the boundary of this system is at the inner surface of the piston, and this motion is in the $+x$ or $-x$ direction. The x component of the force exerted by the system on the surroundings at this portion of the boundary, F_x^{sys} , is equal to F_{gas} . (The other forces shown in Fig. 3.5 are within the surroundings.) Applying the differential form of Eq. 3.1.2, we have $\delta w = -F_{\text{gas}} dx_{\text{pis}}$ which, with the substitution $F_{\text{gas}} = p_{\text{b}} A_{\text{s}}$ (from Eq. 3.4.2), becomes

$$\delta w = -p_{\text{b}} A_{\text{s}} dx_{\text{pis}} \quad (3.4.11)$$

It will be convenient to change the work coordinate from x_{pis} to V . The gas volume is given by $V = A_{\text{s}} x_{\text{pis}}$ so that an infinitesimal change dx changes the volume by $dV = A_{\text{s}} dx_{\text{pis}}$. The infinitesimal quantity of work for an infinitesimal volume change is then given by

$$\delta w = -p_{\text{b}} dV \quad (3.4.12)$$

(expansion work,
closed system)

and the finite work for a finite volume change, found by integrating from the initial to the final volume, is

$$w = - \int_{V_1}^{V_2} p_{\text{b}} dV \quad (3.4.13)$$

(expansion work,
closed system)

During expansion (positive dV), δw is negative and the system does work on the surroundings. During compression (negative dV), δw is positive and the surroundings do work on the system.

When carrying out dimensional analysis, you will find it helpful to remember that the product of two quantities with dimensions of pressure and volume (such as $p_{\text{b}} dV$) has dimensions of energy, and that 1 Pa m^3 is equal to 1 J .

The integral on the right side of Eq. 3.4.13 is a *line integral* (Sec. E.4 on page 481). In order to evaluate the integral, one must be able to express the integrand p_{b} as a function of the integration variable V along the path of the expansion or compression process.

If the piston motion during expansion or compression is sufficiently slow, we can with little error assume that the gas has a uniform pressure p throughout, and that the work can be calculated as if the process has reached its reversible limit. Under these conditions, Eq. 3.4.12 becomes

$$\delta w = -p dV \quad (3.4.14)$$

(reversible expansion
work, closed system)

and Eq. 3.4.13 becomes

$$w = - \int_{V_1}^{V_2} p \, dV \quad (3.4.15)$$

(reversible expansion
work, closed system)

The appearance of the symbol p in these equations, instead of p_b , implies that the equations apply only to a process in which the system has at each instant a single uniform pressure. As a general rule, *an equation containing the symbol of an intensive property not assigned to a specific phase is valid only if that property is uniform throughout the system*, and this will not be explicitly indicated as a condition of validity.

Some texts state that expansion work in a horizontal cylinder-and-piston device like that shown in Fig. 3.5 should be calculated from $w = -\int p_{\text{ext}} \, dV$, where p_{ext} is a pressure in the *surroundings* that exerts the external force F_{ext} on the piston. However, if the system is the gas the correct general expression is the one given by Eq. 3.4.13: $w = -\int p_b \, dV$. This is because it is the force $F_{\text{gas}} = p_b A_s$ that is exerted by the system on the surroundings, whereas the force $F_{\text{ext}} = p_{\text{ext}} A_s$ is exerted by one part of the surroundings on another part of the surroundings.

In other words, if the integrals $\int F_{\text{gas}} \, dx_{\text{pis}}$ and $\int F_{\text{ext}} \, dx_{\text{pis}}$ have different values, it is the first of these two integrals that should be used to evaluate the work: $w = -\int F_{\text{gas}} \, dx_{\text{pis}}$. Both integrals are equal if the expansion or compression process is carried out *reversibly*. This is because in the limit of infinite slowness the piston has neither friction ($F_{\text{fric}}=0$) nor acceleration ($F_{\text{net}}=0$), and therefore according to Eq. 3.4.3, F_{gas} and F_{ext} are equal throughout the process. Another situation in which the two integrals are equal is when the piston is frictionless and is stationary in the initial and final states, because then both F_{fric} and $\int F_{\text{net}} \, dx_{\text{pis}}$ are zero. (The integral $\int F_{\text{net}} \, dx_{\text{pis}}$ can be shown to be equal to the change in the kinetic energy of the piston, by a derivation similar to that leading to Eq. G.1.5 on page 489.) In the general irreversible case, however, the integrals $\int F_{\text{gas}} \, dx_{\text{pis}}$ and $\int F_{\text{ext}} \, dx_{\text{pis}}$ are *not* equal.¹⁵

3.4.3 Expansion work of an isotropic phase

Expansion work does not require a cylinder-and-piston device. Suppose the system is an isotropic fluid or solid phase, and various portions of its boundary undergo displacements in different directions. Figure 3.6 on the next page shows an example of compression in a system of arbitrary shape. The deformation is considered to be carried out slowly, so that the pressure p of the phase remains uniform. Consider the surface element τ of the boundary, with area $A_{s,\tau}$, indicated in the figure by a short thick curve. Because the phase is isotropic, the force $F_{\tau}^{\text{sys}} = p A_{s,\tau}$ exerted by the system pressure on the surroundings is perpendicular to this surface element; that is, there is no shearing force. The force F_{τ}^{sur} exerted by the surroundings on the system is equal in magnitude to F_{τ}^{sys} and is directed in the opposite direction. The volume change for an infinitesimal displacement ds_{τ} that reduces the volume is $dV_{\tau} = -A_{s,\tau} ds_{\tau}$, so that the work at this surface element (from Eq. 3.4.1 with $\alpha_{\tau}=0$) is $\delta w_{\tau} = -p \, dV_{\tau}$.

By summing the work over the entire boundary, we find the total reversible expansion work is given by the same expression as for a gas in a piston-and-cylinder device:

¹⁵For an informative discussion of this topic see Ref. [6]; also comments in Refs. [29], [7], [102], [8], and [129]; also Ref. [99].

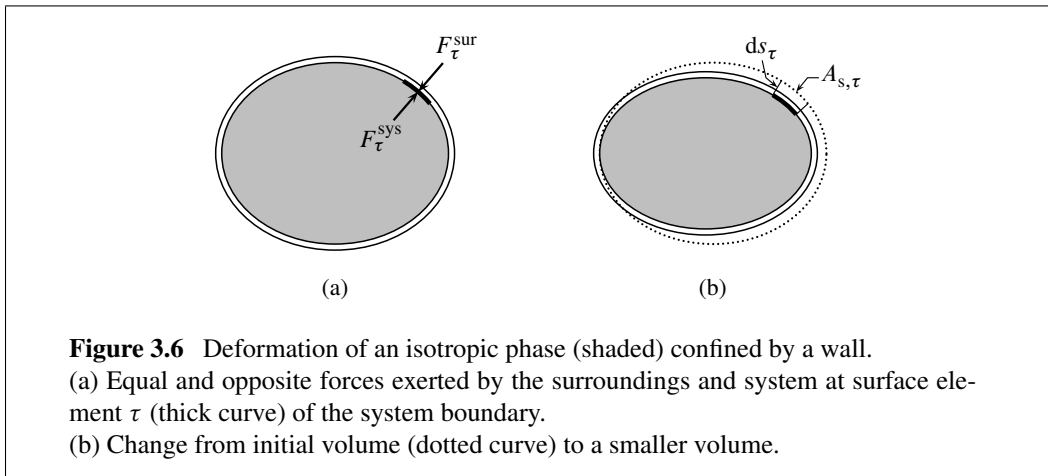

$\delta w = -p dV$. This expression can be used for deformation caused by reversible displacements of a confining wall, or for a volume change caused by slow temperature changes at constant pressure. It is valid if the system is an isotropic fluid phase in which other phases are immersed, provided the fluid phase contacts all parts of the system boundary. The expression is not necessarily valid for an *anisotropic* fluid or solid, because the angle α_τ appearing in Eq. 3.4.1 might not be zero.

3.4.4 Generalities

The expression $\delta w = -p dV$ for reversible expansion work of an isotropic phase is the product of a work coefficient, $-p$, and the infinitesimal change of a work coordinate, V . In the reversible limit, in which all states along the path of the process are equilibrium states, the system has two independent variables, e.g., p and V or T and V . The number of independent variables is one greater than the number of work coordinates. This will turn out to be a general rule: *The number of independent variables needed to describe equilibrium states of a closed system is one greater than the number of independent work coordinates for reversible work.*

Another way to state the rule is as follows: The number of independent variables is one greater than the number of different *kinds* of reversible work, where each kind i is given by an expression of the form $\delta w_i = Y_i dX_i$.

3.5 Applications of Expansion Work

This book uses *expansion work* as a general term that includes the work of both expansion and compression of an isotropic phase.

3.5.1 The internal energy of an ideal gas

The model of an ideal gas is used in many places in the development of thermodynamics. For examples to follow, the following definition is needed: An ideal gas is a gas

1. whose equation of state is the ideal gas equation, $pV = nRT$; and

2. whose internal energy in a closed system is a function only of temperature.¹⁶

On the molecular level, a gas with negligible intermolecular interactions¹⁷ fulfills both of these requirements. Kinetic-molecular theory predicts that a gas containing noninteracting molecules obeys the ideal gas equation. If intermolecular forces (the only forces that depend on intermolecular distance) are negligible, the internal energy is simply the sum of the energies of the individual molecules. These energies are independent of volume but depend on temperature.

The behavior of any real gas approaches ideal-gas behavior when the gas is expanded isothermally. As the molar volume V_m becomes large and p becomes small, the average distance between molecules becomes large, and intermolecular forces become negligible.

3.5.2 Reversible isothermal expansion of an ideal gas

During reversible expansion or compression, the temperature and pressure remain uniform. If we substitute $p = nRT/V$ from the ideal gas equation into Eq. 3.4.15 and treat n and T as constants, we obtain

$$w = -nRT \int_{V_1}^{V_2} \frac{dV}{V} = -nRT \ln \frac{V_2}{V_1} \quad (3.5.1)$$

(reversible isothermal expansion work, ideal gas)

In these expressions for w the amount n appears as a constant for the process, so it is not necessary to state as a condition of validity that the system is closed.

3.5.3 Reversible adiabatic expansion of an ideal gas

This section derives temperature-volume and pressure-volume relations when a fixed amount of an ideal gas is expanded or compressed without heat.

First we need a relation between internal energy and temperature. Since the value of the internal energy of a fixed amount of an ideal gas depends only on its temperature (Sec. 3.5.1), an infinitesimal change dT will cause a change dU that depends only on T and dT :

$$dU = f(T) dT \quad (3.5.2)$$

where $f(T) = dU/dT$ is a function of T . For a constant-volume process of a closed system without work, we know from the first law that dU is equal to δq and that $\delta q/dT$ is equal to C_V , the heat capacity at constant volume (Sec. 3.1.5). Thus we can identify the function $f(T)$ as the heat capacity at constant volume:

$$dU = C_V dT \quad (3.5.3)$$

(ideal gas, closed system)

The relation given by Eq. 3.5.3 is valid for any process of a closed system of an ideal gas of uniform temperature, even if the volume is not constant or if the process is adiabatic, because it is a general relation between state functions.

¹⁶A gas with this second property is sometimes called a “perfect gas.” In Sec. 7.2 it will be shown that if a gas has the first property, it must also have the second.

¹⁷This book uses the terms “intermolecular interactions” and “intermolecular forces” for interactions or forces between either multi-atom molecules or unbonded atoms.

In a reversible adiabatic expansion with expansion work only, the heat is zero and the first law becomes

$$dU = \delta w = -p dV \quad (3.5.4)$$

We equate these two expressions for dU to obtain

$$C_V dT = -p dV \quad (3.5.5)$$

and substitute $p = nRT/V$ from the ideal gas equation:

$$C_V dT = -\frac{nRT}{V} dV \quad (3.5.6)$$

It is convenient to make the approximation that over a small temperature range, C_V is constant. When we divide both sides of the preceding equation by T in order to separate the variables T and V , and then integrate between the initial and final states, we obtain

$$C_V \int_{T_1}^{T_2} \frac{dT}{T} = -nR \int_{V_1}^{V_2} \frac{dV}{V} \quad (3.5.7)$$

$$C_V \ln \frac{T_2}{T_1} = -nR \ln \frac{V_2}{V_1} \quad (3.5.8)$$

We can rearrange this result into the form

$$\ln \frac{T_2}{T_1} = -\frac{nR}{C_V} \ln \frac{V_2}{V_1} = \ln \left(\frac{V_1}{V_2} \right)^{nR/C_V} \quad (3.5.9)$$

and take the exponential of both sides:

$$\frac{T_2}{T_1} = \left(\frac{V_1}{V_2} \right)^{nR/C_V} \quad (3.5.10)$$

The final *temperature* is then given as a function of the initial and final volumes by

$$T_2 = T_1 \left(\frac{V_1}{V_2} \right)^{nR/C_V} \quad (3.5.11)$$

(reversible adiabatic expansion, ideal gas)

This relation shows that the temperature decreases during an adiabatic expansion and increases during an adiabatic compression, as expected from expansion work on the internal energy.

To find the *work* during the adiabatic volume change, we can use the relation

$$\begin{aligned} w &= \Delta U = \int dU = C_V \int_{T_1}^{T_2} dT \\ &= C_V(T_2 - T_1) \end{aligned} \quad (3.5.12)$$

(reversible adiabatic expansion, ideal gas)

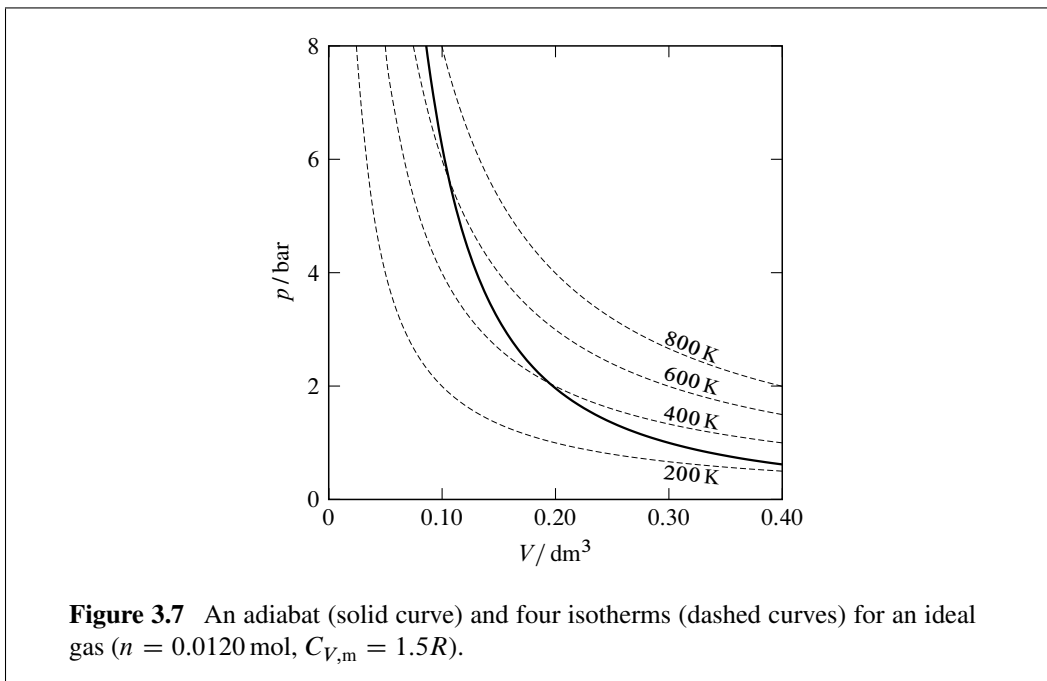

To express the final *pressure* as a function of the initial and final volumes, we make the substitutions $T_1 = p_1 V_1 / nR$ and $T_2 = p_2 V_2 / nR$ in Eq. 3.5.11 and obtain

$$\frac{p_2 V_2}{nR} = \frac{p_1 V_1}{nR} \left(\frac{V_1}{V_2} \right)^{nR/C_V} \quad (3.5.13)$$

Solving this equation for p_2 , we obtain finally

$$p_2 = p_1 \left(\frac{V_1}{V_2} \right)^{1+nR/C_V} \quad (3.5.14)$$

(reversible adiabatic expansion, ideal gas)

The solid curve in Fig. 3.7 shows how the pressure of an ideal gas varies with volume during a reversible adiabatic expansion or compression. This curve is an *adiabat*. The dashed curves in the figure are *isotherms* showing how pressure changes with volume at constant temperature according to the equation of state $p = nRT/V$. In the direction of increasing V (expansion), the adiabat crosses isotherms of progressively lower temperatures. This cooling effect, of course, is due to the loss of energy by the gas as it does work on the surroundings without a compensating flow of heat into the system.

3.5.4 Indicator diagrams

An **indicator diagram** (or pressure–volume diagram) is usually a plot of p as a function of V . The curve describes the path of an expansion or compression process of a fluid that is essentially uniform. The area under the curve has the same value as the integral $\int p \, dV$, which is the negative of the reversible expansion work given by $w = -\int p \, dV$. For example, the area under the solid curve of Fig. 3.7 between any two points on the curve is equal to

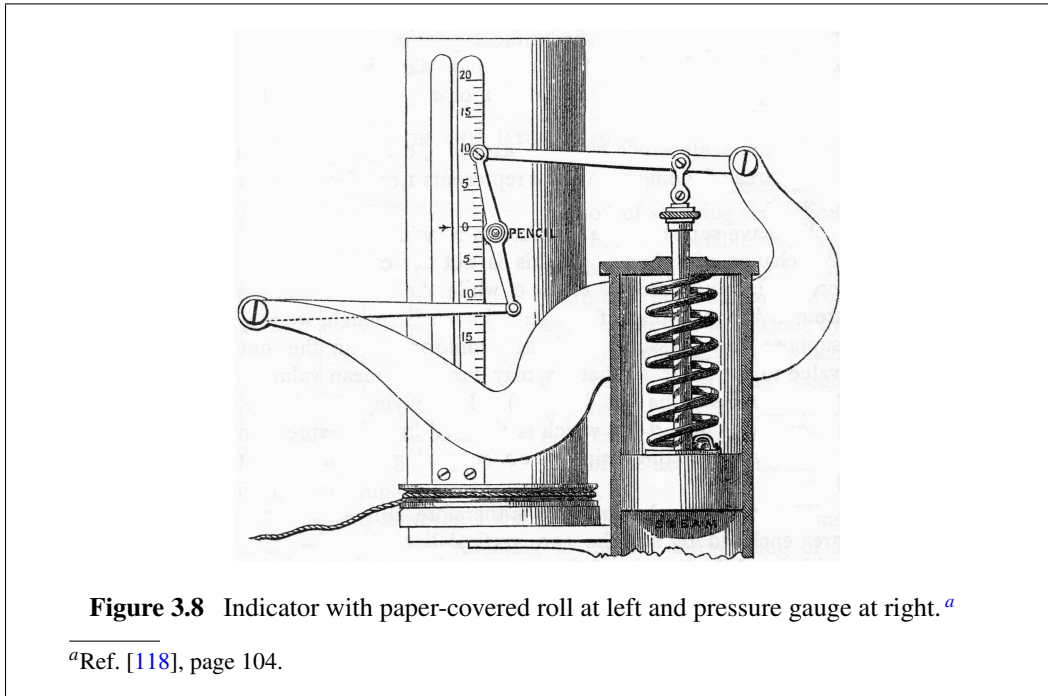

Figure 3.8 Indicator with paper-covered roll at left and pressure gauge at right.^a

^aRef. [118], page 104.

$-w$ for reversible adiabatic expansion or compression. If the direction of the process is to the right along the path (expansion), the area is positive and the work is negative; but if the direction is to the left (compression), the area is taken as negative and the work is positive.

More generally, an indicator diagram can be a plot of a work coefficient or its negative as a function of the work coordinate. For example, it could be a plot of the pressure p_b at a moving boundary as a function of V . The area under this curve is equal to $\int p_b dV$, the negative of expansion work in general (Eq. 3.4.13).

Historically, an indicator diagram was a diagram drawn by an “indicator,” an instrument invented by James Watt in the late 1700s to monitor the performance of steam engines. The steam engine indicator was a simple pressure gauge: a piston moving in a small secondary cylinder, with the steam pressure of the main cylinder on one side of the piston and a compressed spring opposing this pressure on the other side. A pointer attached to the small piston indicated the steam pressure. In later versions, the pointer was replaced with a pencil moving along a paper-covered roll, which in turn was mechanically linked to the piston of the main cylinder (see Fig. 3.8). During each cycle of the engine, the pencil moved back and forth along the length of the roll and the roll rotated in a reciprocating motion, causing the pencil to trace a closed curve whose area was proportional to the net work performed by one cycle of the engine.

3.5.5 Spontaneous adiabatic expansion or compression

Section 3.4.1 explained that during a rapid spontaneous expansion of the gas in the cylinder shown in Fig. 3.5, the pressure p_b exerted by the gas at the moving piston is less than the pressure at the stationary wall. Consequently the work given by $w = -\int p_b dV$ is less negative for a spontaneous adiabatic expansion than for a reversible adiabatic expansion with the same initial state and the same volume change.

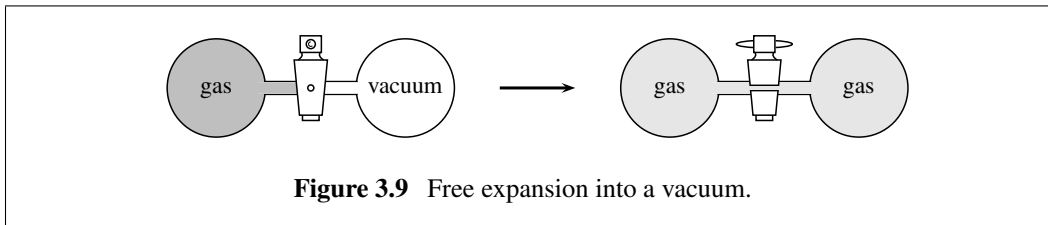

Figure 3.9 Free expansion into a vacuum.

During a rapid spontaneous *compression*, p_b is greater than the pressure at the stationary wall. The work is positive and greater for a spontaneous adiabatic compression than for a reversible adiabatic compression with the same initial state and the same volume change.

These observations are summarized by the statement that, for an adiabatic expansion or compression with a given change of the work coordinate, starting at a given initial equilibrium state, the work is algebraically smallest (least positive or most negative) in the reversible limit. That is, in the reversible limit the surroundings do the least possible work on the system and the system does the maximum possible work on the surroundings. This behavior will turn out to be true of any adiabatic process of a closed system.

3.5.6 Free expansion of a gas into a vacuum

When we open the stopcock of the apparatus shown in Fig. 3.9, the gas expands from the vessel at the left into the evacuated vessel at the right. This process is called **free expansion**. The *system* is the gas. The surroundings exert a contact force on the system only at the vessel walls, where there is no displacement. Thus, there is *no* work in free expansion: $\delta w = 0$.

If the free expansion is carried out adiabatically in a thermally-insulated apparatus, there is neither heat nor work and therefore no change in the internal energy: $\Delta U = 0$. If the gas is ideal, its internal energy depends only on temperature; thus the adiabatic free expansion of an ideal gas causes no temperature change.

3.6 Work in a Gravitational Field

Figure 3.10 on the next page depicts a spherical body, such as a glass marble, immersed in a liquid or gas in the presence of an external gravitational field. The vessel containing the fluid is stationary on a lab bench, and the local reference frame for work is a stationary lab frame. The variable z is the body's elevation above the bottom of the vessel. All displacements are parallel to the vertical z axis. From Eq. 3.1.1, the work is given by $\delta w = F_z^{\text{sur}} dz$ where F_z^{sur} is the upward component of the net contact force exerted by the surroundings on the system at the moving portion of the boundary. There is also a downward gravitational force on the body, but as explained in Sec. 3.1.1, this force does not contribute to F_z^{sur} .

Consider first the simple process in Fig. 3.10(a) in which the body falls freely through the fluid. This process is clearly spontaneous. Here are two choices for the definition of the system:

- The system is the combination of the spherical body and the fluid. The system boundary is where the fluid contacts the atmosphere and the vessel walls. Because there is no displacement of this boundary, *no* work is being done on or by the system: $\delta w = 0$. (We ignore expansion work caused by the small temperature increase.) If the process is adiabatic, the first law tells us the system's internal energy remains

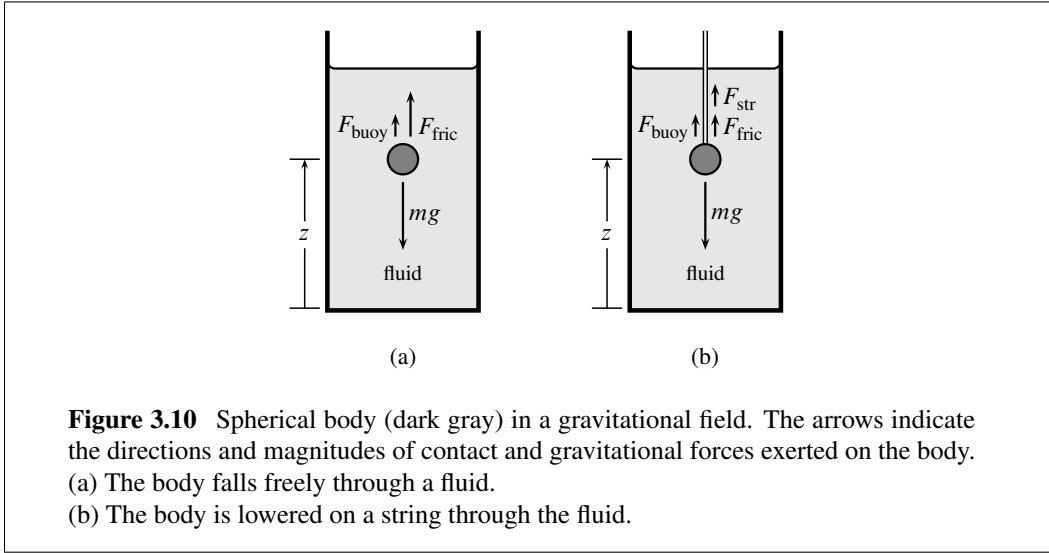

Figure 3.10 Spherical body (dark gray) in a gravitational field. The arrows indicate the directions and magnitudes of contact and gravitational forces exerted on the body. (a) The body falls freely through a fluid. (b) The body is lowered on a string through the fluid.

constant: as the body loses gravitational potential energy, the system gains an equal quantity of kinetic and thermal energy.

- The system is the body; the fluid is in the surroundings. The upward components of the forces exerted on the body are (1) a gravitational force $-mg$, where m is the body's mass and g is the acceleration of free fall; (2) a buoyant force¹⁸ $F_{\text{buoy}} = \rho V' g$, where ρ is the fluid density and V' is the volume of the body; and (3) a frictional drag force F_{fric} of opposite sign from the velocity $v = dz/dt$. As mentioned above, the gravitational force is not included in F_z^{sur} . Therefore the gravitational work is given by

$$\dot{d}w = F_z^{\text{sur}} dz = (F_{\text{buoy}} + F_{\text{fric}}) dz \quad (3.6.1)$$

and is negative because dz is negative: the body as it falls does work on the fluid. The positive quantity $|F_{\text{buoy}} dz|$ is the work of moving displaced fluid upward, and $|F_{\text{fric}} dz|$ is the energy dissipated by friction to thermal energy in the surroundings. This process has no reversible limit, because the rate of energy transfer cannot be controlled from the surroundings and cannot be made to approach zero.

Next, consider the arrangement in Fig. 3.10(b) in which the body is suspended by a thin string. The string is in the surroundings and provides a means for the surroundings to exert an upward contact force on the body. As before, there are two appropriate choices for the system:

- The system includes both the body and the fluid, but not the string. The moving part of the boundary is at the point where the string is attached to the body. The force exerted here by the string is an upward force F_{str} , and the gravitational work is given by $\dot{d}w = F_z^{\text{sur}} dz = F_{\text{str}} dz$. According to Newton's second law, the net force on the body equals the product of its mass and acceleration: $(-mg + F_{\text{buoy}} + F_{\text{fric}} + F_{\text{str}}) = m dv/dt$. Solving this equation for F_{str} , we obtain

$$F_{\text{str}} = (mg - F_{\text{buoy}} - F_{\text{fric}} + m dv/dt) \quad (3.6.2)$$

¹⁸The buoyant force is a consequence of the pressure gradient that exists in the fluid in a gravitational field (see Sec. 8.1.4). We ignore this gradient when we treat the fluid as a uniform phase.

We can therefore express the work in the form

$$\delta w = F_{\text{str}} dz = (mg - F_{\text{buoy}} - F_{\text{fric}} + m dv/dt) dz \quad (3.6.3)$$

This work can be positive or negative, depending on whether the body is being pulled up or lowered by the string. The quantity $(m dv/dt) dz$ is an infinitesimal change of the body's kinetic energy E_k ,¹⁹ so that the integral $\int (m dv/dt) dz$ is equal to ΔE_k . The finite quantity of work in a process that starts and ends in equilibrium states, so that ΔE_k is zero, is therefore

$$w = \int \delta w = (mg - F_{\text{buoy}}) \Delta z - \int F_{\text{fric}} dz \quad (3.6.4)$$

The work has a reversible limit, because the string allows the velocity v to be controlled from the surroundings. As v approaches zero from either direction, F_{fric} approaches zero and the work approaches the reversible limit $w = (mg - F_{\text{buoy}})\Delta z$. (If the fluid is a gas whose density is much smaller than the density of the body, F_{buoy} can be neglected in comparison with mg , and the reversible work can be written $w = mg\Delta z$.) F_{fric} and dz have opposite signs, so w for a given change of the work coordinate z is least positive or most negative in the reversible limit.

- The system is the body only. In this case, F_z^{sur} is equal to $(F_{\text{buoy}} + F_{\text{fric}} + F_{\text{str}})$ which by substitution from Eq. 3.6.2 is $(mg + m dv/dt)$. The work is then given by

$$\delta w = F^{\text{sur}} dz = (mg + m dv/dt) dz \quad (3.6.5)$$

For a process that begins and ends in equilibrium states, ΔE_k is zero and the finite work is $w = mg\Delta z$, unaffected by the velocity v during the process. The expressions for infinitesimal and finite work in the reversible limit are

$$\delta w = mg dz \quad \text{and} \quad w = mg\Delta z \quad (3.6.6)$$

(reversible gravitational
work of a body)

When we compare Eqs. 3.6.3 and 3.6.5, we see that the work when the system is the body is greater by the quantity $(F_{\text{buoy}} + F_{\text{fric}}) dz$ than the work when the system is the combination of body and fluid, just as in the case of the freely-falling body. The difference in the quantity of work is due to the different choices of the system boundary where contact forces are exerted by the surroundings.

3.7 Shaft Work

Shaft work refers to energy transferred across the boundary by a rotating shaft.

The two systems shown in Fig. 3.11 on the next page will be used to illustrate two different kinds of shaft work. Both systems have a straight cylindrical shaft passing through the system boundary. Let ϑ be the angle of rotation of the shaft in radians, and ω be the angular velocity $d\vartheta/dt$.

¹⁹To prove this, we write $m(dv/dt) dz = m(dz/dt) dv = mv dv = d(\frac{1}{2}mv^2) = dE_k$.

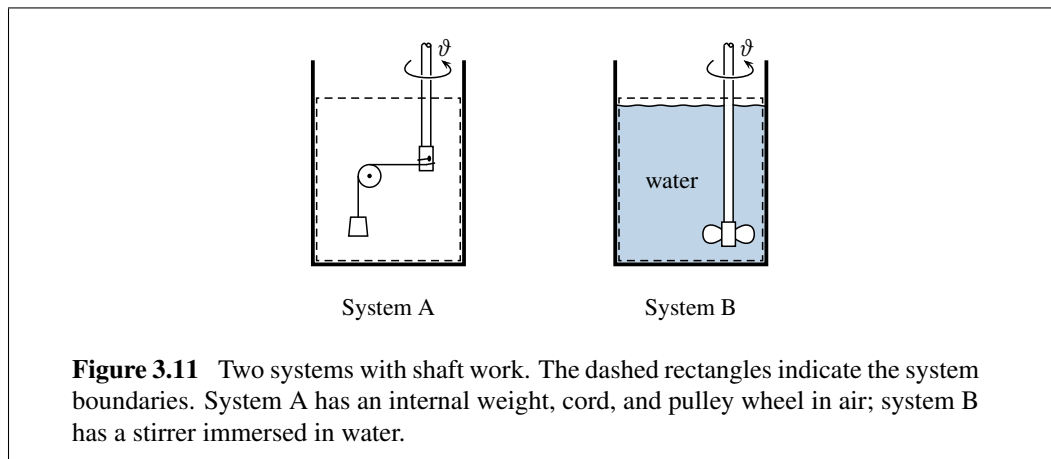

Figure 3.11 Two systems with shaft work. The dashed rectangles indicate the system boundaries. System A has an internal weight, cord, and pulley wheel in air; system B has a stirrer immersed in water.

Tangential forces imposed on one of these shafts can create a torque τ_{sys} at the lower end within the system, and a torque τ_{sur} at the upper end in the surroundings.²⁰ The sign convention for a torque is that a positive value corresponds to tangential forces in the rotational direction in which the shaft turns as ϑ increases.

The condition for ω to be zero, or finite and constant (i.e., no angular acceleration), is that the algebraic sum of the imposed torques be zero: $\tau_{\text{sys}} = -\tau_{\text{sur}}$. Under these conditions of constant ω , the torque couple creates rotational shear forces in the circular cross section of the shaft where it passes through the boundary. These shear forces are described by an *internal torque* with the same magnitude as τ_{sys} and τ_{sur} . Applying the condition for zero angular acceleration to just the part of the shaft within the system, we find that τ_{sys} is balanced by the internal torque τ_{b} exerted on this part of the shaft by the part of the shaft in the surroundings: $\tau_{\text{b}} = -\tau_{\text{sys}}$. The shaft work is then given by the formula

$$w = \int_{\vartheta_1}^{\vartheta_2} \tau_{\text{b}} d\vartheta = - \int_{\vartheta_1}^{\vartheta_2} \tau_{\text{sys}} d\vartheta \quad (3.7.1)$$

(shaft work, constant ω)

In system A of Fig. 3.11, when ω is zero the torque τ_{sys} is due to the tension in the cord from the weight of mass m , and is finite: $\tau_{\text{sys}} = -mgr$ where r is the radius of the shaft at the point where the cord is attached. When ω is finite and constant, frictional forces at the shaft and pulley bearings make τ_{sys} more negative than $-mgr$ if ω is positive, and less negative than $-mgr$ if ω is negative. Figure 3.12(a) on the next page shows how the shaft work given by Eq. 3.7.1 depends on the angular velocity for a fixed value of $|\vartheta_2 - \vartheta_1|$. The variation of w with ω is due to the frictional forces. System A has finite, reversible shaft work in the limit of infinite slowness ($\omega \rightarrow 0$) given by $w = mgr\Delta\vartheta$. The shaft work is least positive or most negative in the reversible limit.

In contrast to system A, the shaft work in system B has no reversible limit, as discussed in the next section.

3.7.1 Stirring work

The shaft work done when a shaft turns a stirrer or paddle to agitate a liquid, as in system B of Fig. 3.11, is called **stirring work**.

²⁰A torque is a moment of tangential force with dimensions of force times distance.

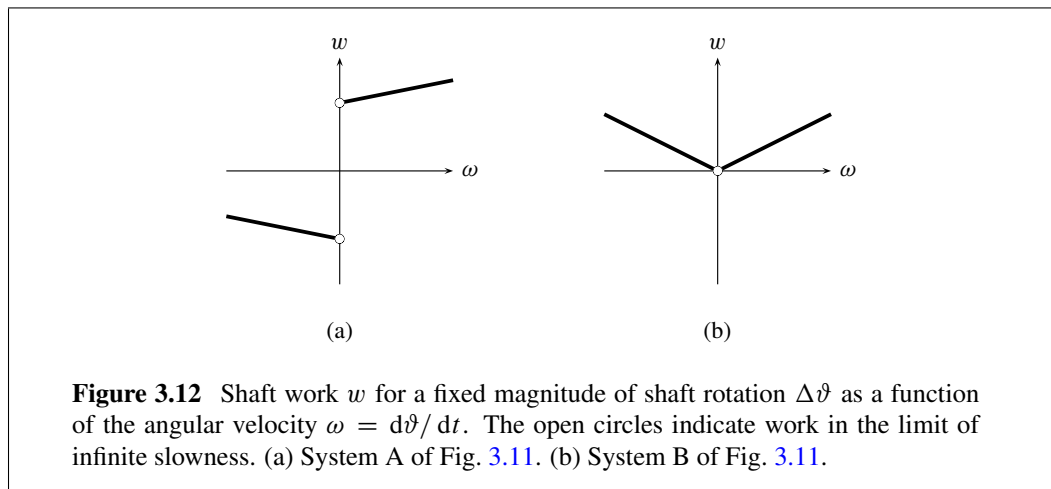

In system B, when the angular velocity ω is zero and the water in which the stirrer is immersed is at rest, the torques τ_{sys} and τ_b are both zero. When ω is finite and constant, the water is stirred in a turbulent manner and there is a frictional drag force at the stirrer blades, as well as frictional forces at the shaft bearings. These forces make the value of τ_{sys} have the opposite sign from ω , increasing in magnitude the greater is the magnitude of ω . As a result, the stirring work for a fixed value of $|\vartheta_2 - \vartheta_1|$ depends on ω in the way shown in Fig. 3.12(b). The work is positive for finite values of ω of either sign, and approaches zero in the limit of infinite slowness.

Stirring work is an example of **dissipative work**. Dissipative work is work that is positive for both positive and negative changes of the work coordinate, and therefore cannot be carried out reversibly. Energy transferred into the system by dissipative work is not recovered as work done on the surroundings when the work coordinate is reversed. In the case of stirring work, if the shaft rotates in one direction work is done on the system; if the rotation direction is reversed, still more work is done on the system. The energy transferred to the system by stirring work is converted by friction within the system into the random motion of thermal energy: the energy is completely *dissipated*.

Because energy transferred to the system by dissipative work is converted to thermal energy, we could replace this work with an equal quantity of positive heat and produce the same overall change. The replacement of stirring work with heat was illustrated by experiment 3 on page 62.

The shaft rotation angle ϑ , which is the work coordinate for stirring work, is a property of the system but is not a state function, as we can see by the fact that the state of the system can be exactly the same for $\vartheta = 0$ and $\vartheta = 2\pi$. The work coordinate and work coefficient of work with a reversible limit are always state functions, whereas the work coordinate of any kind of dissipative work is *not* a state function.

In system B of Fig. 3.11, there is in addition to the stirring work the possibility of expansion work given by $\delta w = -p dV$. When we take both kinds of work into account, we must treat this system as having two work coordinates: ϑ for stirring work and V for expansion work. Only the expansion work can be carried out reversibly. The number of independent variables in equilibrium states of this system is two, which we could choose as T and V . Thus, the number of independent variables of the equilibrium states is one greater

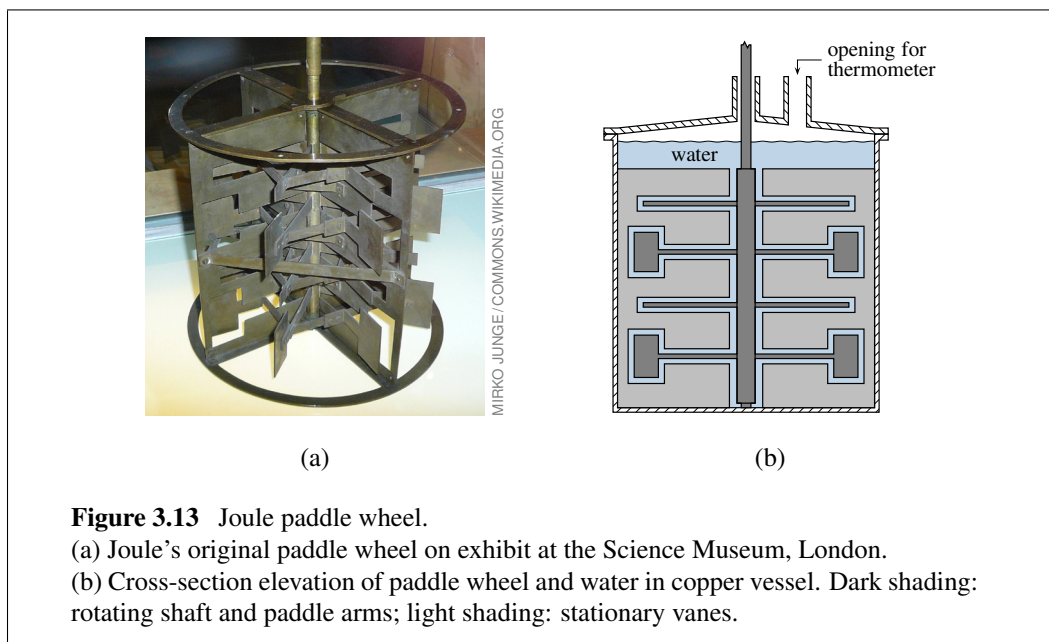

than the number of work coordinates for *reversible* work, in agreement with the general rule given on page 77.

3.7.2 The Joule paddle wheel

A good example of the quantitative measurement of stirring work is the set of experiments conducted by James Joule in the 1840s to determine the “mechanical equivalent of heat.” In effect, he determined the quantity of dissipative stirring work that could replace the heat needed for the same temperature increase.

Joule’s apparatus contained the paddle wheel shown in Fig. 3.13. It consisted of eight sets of metal paddle arms attached to a shaft in a water-filled copper vessel. When the shaft rotated, the arms moved through openings in four sets of stationary metal vanes fixed inside the vessel, and churned the water. The vanes prevented the water from simply moving around in a circle. The result was turbulent motion (shearing or viscous flow) in the water and an increase in the temperature of the entire assembly.

The complete apparatus is depicted in Fig. 3.14 on page 89. In use, two lead weights sank and caused the paddle wheel to rotate. Joule evaluated the stirring work done on the system (the vessel, its contents, and the lid) from the change of the vertical position h of the weights. To a first approximation, this work is the negative of the change of the weights’ potential energy: $w = -mg\Delta h$ where m is the combined mass of the two weights. Joule made corrections for the kinetic energy gained by the weights, the friction in the connecting strings and pulley bearings, the elasticity of the strings, and the heat gain from the air surrounding the system.

A typical experiment performed by Joule is described in Prob. 3.10 on page 103. His results for the mechanical equivalent of heat, based on 40 such experiments at average temperatures in the range 13°C – 16°C and expressed as the work needed to increase the temperature of one gram of water by one kelvin, was 4.165 J. This value is close to the

BIOGRAPHICAL SKETCH

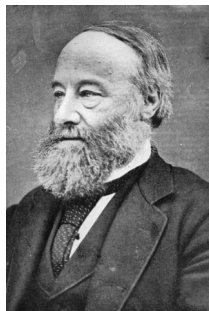
James Prescott Joule (1818–1889)

James Joule drove the final nails into the coffin of the caloric theory by his experimental demonstrations of the mechanical equivalent of heat.

Joule (pronounced like “jewel”) was born in Salford, near Manchester, England. His father was a prosperous brewery owner; after his death, James and one of his brothers carried on the business until it was sold in 1854.

Joule was a sickly child with a minor spinal weakness. He was tutored at home, and at the age of 16 was a pupil of the atomic theory advocate John Dalton.

As an adult, Joule was a political conservative and a member of the Church of England. He dressed plainly, was of a somewhat nervous disposition, and was a poor speaker. He was shy and reserved unless with friends, had a strong sense of humor, and loved nature.

Joule never attended a university or had a university appointment, but as an “amateur” scientist and inventor he published over 100 papers (some of them jointly with collaborators) and received many honors. He invented arc welding and a mercury displacement pump. He carried out investigations on electrical heating and, in collaboration with William Thomson, on the cooling accompanying the expansion of a gas through a porous plug (the Joule–Thomson experiment). The *joule*, of course, is now the SI derived unit of energy.

Joule’s best-known experiment was the de-

termination of the mechanical equivalent of heat using a paddle wheel to agitate water (Sec. 3.7.2 and Prob. 3.10). He reported his results in 1845, and published a more refined measurement in 1850.^a

In a note dated 1885 in his *Collected Papers*, Joule wrote:

It was in the year 1843 that I read a paper “On the Calorific Effects of Magneto-Electricity and the Mechanical Value of Heat” to the Chemical Section of the British Association assembled at Cork. With the exception of some eminent men ... the subject did not excite much general attention; so that when I brought it forward again at the meeting in 1847, the chairman suggested that, as the business of the section pressed, I should not read my paper, but confine myself to a short verbal description of my experiments. This I endeavoured to do, and discussion not being invited, the communication would have passed without comment if a young man had not risen in the section, and by his intelligent observations created a lively interest in the new theory. The young man was William Thomson, who had two years previously passed the University of Cambridge with the highest honour, and is now probably the foremost scientific authority of the age.

The William Thomson mentioned in Joule’s note later became Lord Kelvin. Thomson described introducing himself to Joule after the 1847 meeting, which was in Oxford, as a result of which the two became collaborators and life-long friends. Thomson wrote:^b

Joule’s paper at the Oxford meeting made a great sensation. Faraday was there and was much struck with it, but did not enter fully into the new views. It was many years after that before any of the scientific chiefs began to give their adhesion.

According to a biographer:^c

His modesty was always notable. ‘I believe,’ he told his brother on 14 Sept. 1887, ‘I have done two or three little things, but nothing to make a fuss about.’ During the later years of his life he received many distinctions both English and foreign.

^aRef. [91]. ^bRef. [17]. ^cRef. [71].

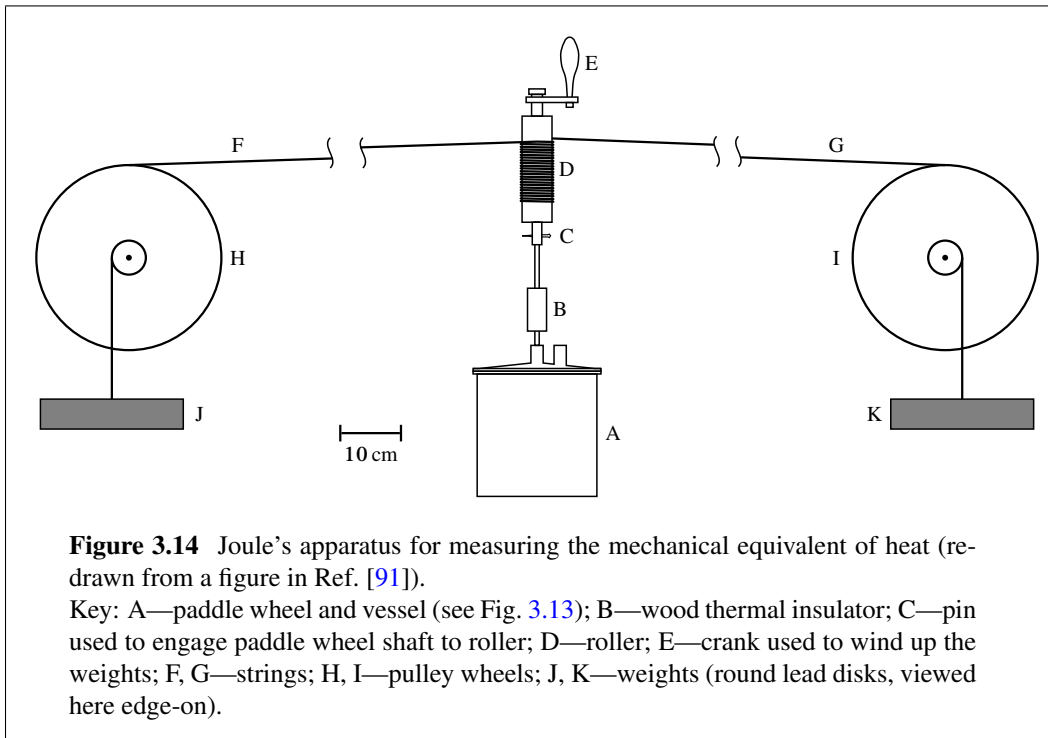

modern value of 4.1855 J for the “15 °C calorie,” the energy needed to raise the temperature of one gram of water from 14.5 °C to 15.5 °C.²¹

3.8 Electrical Work

The electric potential ϕ at a point in space is defined as the work needed to reversibly move an infinitesimal test charge from a position infinitely far from other charges to the point of interest, divided by the value of the test charge. The electrical potential energy of a charge at this point is the product of ϕ and the charge.

3.8.1 Electrical work in a circuit

Electric current is usually conducted in an electrical circuit. Consider a thermodynamic system that is part of a circuit: in a given time period electrons enter the system through one wire, and an equal number of electrons leave through a second wire. To simplify the description, the wires are called the *right* conductor and the *left* conductor.

The electric potentials experienced by a electron in the right and left conductors are ϕ_R and ϕ_L , respectively. The electron charge is $-e$, where e is the elementary charge (the charge of a proton). Thus the electrical potential energy of an electron is $-\phi_R e$ in the right conductor and $-\phi_L e$ in the left conductor. The difference in the energies of an electron in the two conductors is the difference in the electrical potential energies.

²¹The thermochemical calorie (cal), often used as an energy unit in the older literature, is defined as 4.184 J. Thus 1 kcal = 4.184 kJ.

The sum of charges of a small number of electrons can be treated as an infinitesimal negative charge. During a period of time in which an infinitesimal charge $\mathring{d}Q_{\text{sys}}$ enters the system at the right conductor and an equal charge leaves at the left conductor, the contribution of the electric current to the internal energy change is the energy difference $(\phi_R \mathring{d}Q_{\text{sys}} - \phi_L \mathring{d}Q_{\text{sys}}) = (\phi_R - \phi_L) \mathring{d}Q_{\text{sys}}$. (The notation is $\mathring{d}Q_{\text{sys}}$ instead of dQ_{sys} , because Q_{sys} is a path function.) This internal energy change is called *electrical work*. Thus the general formula for an infinitesimal quantity of electrical work when the system is part of an electrical circuit is

$$\mathring{d}w_{\text{el}} = \Delta\phi \mathring{d}Q_{\text{sys}} \quad (3.8.1)$$

(electrical work in a circuit)

where $\Delta\phi$ is the *electric potential difference* defined by

$$\Delta\phi \stackrel{\text{def}}{=} \phi_R - \phi_L \quad (3.8.2)$$

Note that in the expression $(\phi_R \mathring{d}Q_{\text{sys}} - \phi_L \mathring{d}Q_{\text{sys}})$ for the energy difference, the term $\phi_R \mathring{d}Q_{\text{sys}}$ does not represent the energy transferred across the boundary at the right conductor, and $-\phi_L \mathring{d}Q_{\text{sys}}$ is not the energy transferred at the left conductor. These energies cannot be measured individually, because they include not just the electrical potential energy but also the energy of the rest mass of the electrons. The reason we can write Eq. 3.8.1 for the electrical work in a circuit is that equal numbers of electrons enter and leave the system, so that the net energy transferred across the boundary depends only on the difference of the electric potential energies. Because the number of electrons in the system remains constant, we can treat the system as if it were closed.

Why should we regard the transfer of energy across the boundary by an electric current as a kind of work? One justification for doing so is that the energy transfer is consistent with the interpretation of work discussed on page 59: the only effect on the surroundings could be a change in the elevation of an external weight. For example, the weight when it sinks could drive a generator in the surroundings that does electrical work on the system, and electrical work done by the system could run an external motor that raises the weight.

What is the meaning of Q_{sys} in the differential $\mathring{d}Q_{\text{sys}}$? We define Q_{sys} as the total cumulative charge, positive or negative, that has entered the system at the right conductor since the beginning of the process: $Q_{\text{sys}} \stackrel{\text{def}}{=} \int \mathring{d}Q_{\text{sys}}$. Q_{sys} is a path function for charge, and $\mathring{d}Q_{\text{sys}}$ is its inexact differential, analogous to q and $\mathring{d}q$ for heat. Because the charge of an electron is negative, $\mathring{d}Q_{\text{sys}}$ is negative when electrons enter at the right conductor and positive when they leave there.

The electric current I is the rate at which charges pass a point in the circuit: $I = \mathring{d}Q_{\text{sys}}/dt$, where t is time. We take I as negative if electrons enter at the right conductor and positive if electrons leave there. This relation provides an alternative form of Eq. 3.8.1:

$$\mathring{d}w_{\text{el}} = I \Delta\phi dt \quad (3.8.3)$$

(electrical work in a circuit)

Equations 3.8.1 and 3.8.3 are general equations for electrical work in a system that is part of a circuit. The electric potential difference $\Delta\phi$ which appears in these equations may have its source in the surroundings, as for electrical heating with a resistor discussed in the next section, or in the system, as in the case of a galvanic cell (Sec. 3.8.3).

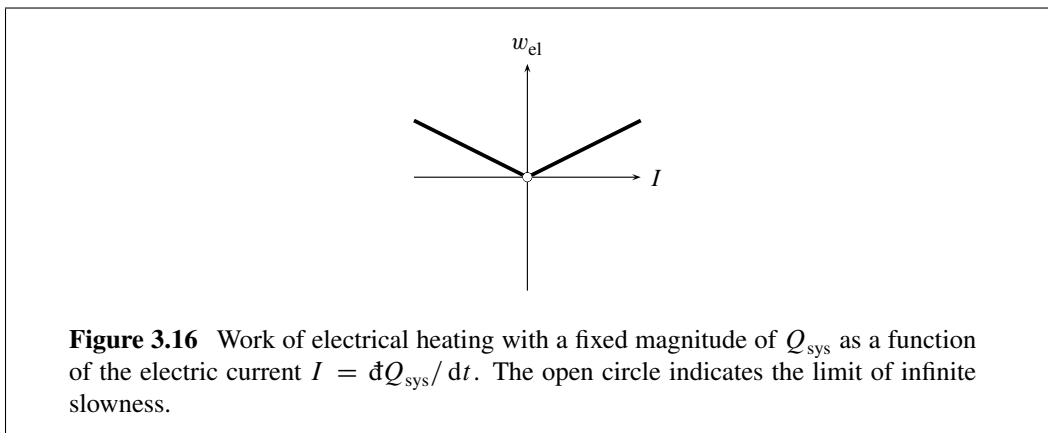
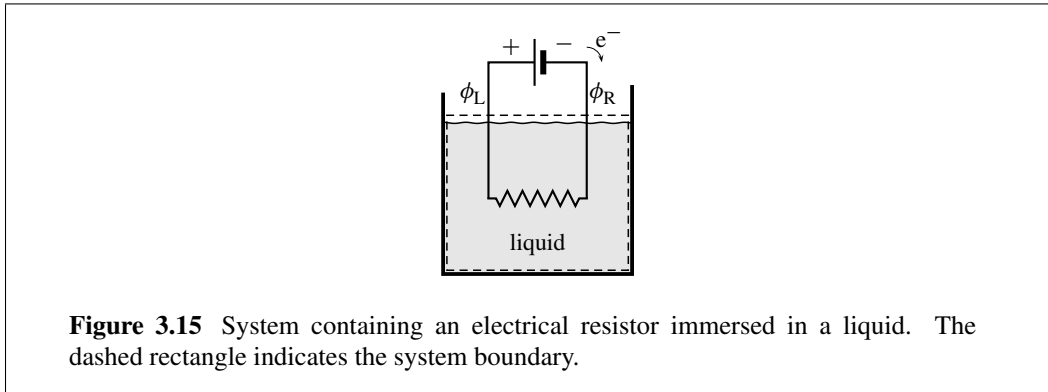

3.8.2 Electrical heating

Figure 3.15 shows an electrical resistor immersed in a liquid. We will begin by defining the system to include both the resistor and the liquid. An external voltage source provides an electric potential difference $\Delta\phi$ across the wires. When electrons flow in the circuit, the resistor becomes warmer due to the ohmic resistance of the resistor. This phenomenon is variously called electrical heating, Joule heating, ohmic heating, or resistive heating. The heating is caused by inelastic collisions of the moving electrons with the stationary atoms of the resistor, a type of friction. If the resistor becomes warmer than the surrounding liquid, there will be a transfer of thermal energy from the resistor to the liquid.

The electrical work performed on this system is given by the expressions $\dot{w}_{\text{el}} = \Delta\phi \dot{Q}_{\text{sys}}$ and $\dot{w}_{\text{el}} = I\Delta\phi$ (Eqs. 3.8.1 and 3.8.3). The portion of the electrical circuit inside the system has an electric resistance given by $R_{\text{el}} = \Delta\phi/I$ (Ohm's law). Making the substitution $\Delta\phi = IR_{\text{el}}$ in the work expressions gives two new expressions for electrical work in this system:

$$\dot{w}_{\text{el}} = IR_{\text{el}} \dot{Q}_{\text{sys}} \quad (3.8.4)$$

$$\dot{w}_{\text{el}} = I^2 R_{\text{el}} \quad (3.8.5)$$

The integrated form of Eq. 3.8.4 when I and R_{el} are constant is $w_{\text{el}} = IR_{\text{el}}Q_{\text{sys}}$. When the source of the electric potential difference is in the surroundings, as it is here, I and Q_{sys} have the same sign, so w_{el} is positive for finite current and zero when there is no current. Figure 3.16 shows graphically how the work of electrical heating is positive for

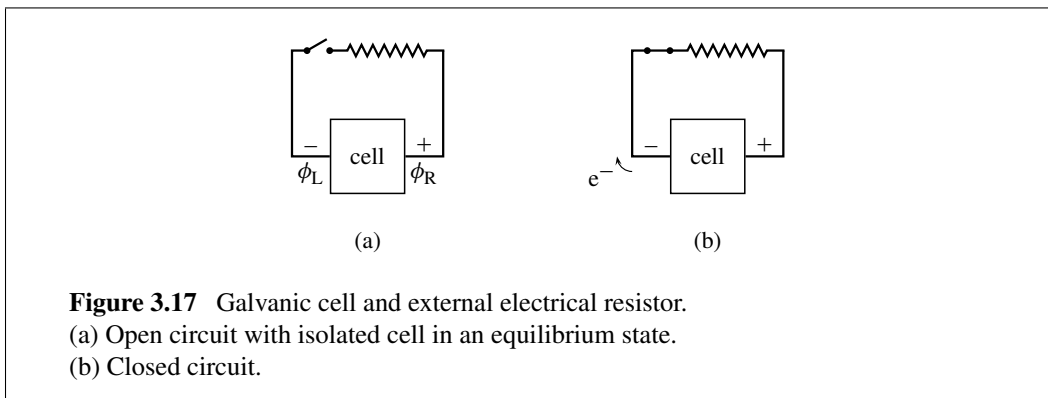

both positive and negative changes of the work coordinate Q_{sys} and vanishes as I , the rate of change of the work coordinate, approaches zero. These are characteristic of irreversible *dissipative* work (page 86). Note the resemblance of Fig. 3.16 to Fig. 3.12(b) on page 86 for dissipative stirring work—they are the same graphs with different labels.

Suppose we redefine the system to be only the liquid. In this case, electric current passes through the resistor but not through the system boundary. There is no electrical work, and we must classify energy transfer between the resistor and the liquid as *heat*.

3.8.3 Electrical work with a galvanic cell

A *galvanic cell* is an electrochemical system that, when isolated, exhibits an electric potential difference between the two terminals at the system boundary. The potential difference has its source at the interfaces between phases within the cell.

Consider the combination of galvanic cell and electrical resistor in Fig. 3.17, and let the *system* be the cell. When an electric current passes through the cell in either direction, a cell reaction takes place in one direction or the other.

In a manner similar to the labeling of the conductors of a circuit, the cell terminals are called the *right* terminal and the *left* terminal. The *cell potential* E_{cell} is the electric potential difference between the terminals, and is defined by

$$E_{\text{cell}} \stackrel{\text{def}}{=} \phi_{\text{R}} - \phi_{\text{L}} \quad (3.8.6)$$

When the cell is in an isolated zero-current equilibrium state, as in Fig. 3.17(a), the cell potential is the *equilibrium cell potential* $E_{\text{cell,eq}}$. When the cell is part of an electrical circuit with an electric current passing through the cell, as in Fig. 3.17(b), E_{cell} is different from $E_{\text{cell,eq}}$ on account of the internal resistance R_{cell} of the cell:

$$E_{\text{cell}} = E_{\text{cell,eq}} + IR_{\text{cell}} \quad (3.8.7)$$

The sign of the current I is negative when electrons enter the cell at the right terminal, and positive when electrons leave there.

In the circuit shown in Fig. 3.17(b), the cell does electrical work on the resistor in the surroundings. The energy for this work comes from the cell reaction. The formula for the electrical work is given by Eq. 3.8.1 with $\Delta\phi$ replaced by E_{cell} :

$$\delta w_{\text{el}} = E_{\text{cell}} \delta Q_{\text{sys}} \quad (3.8.8)$$

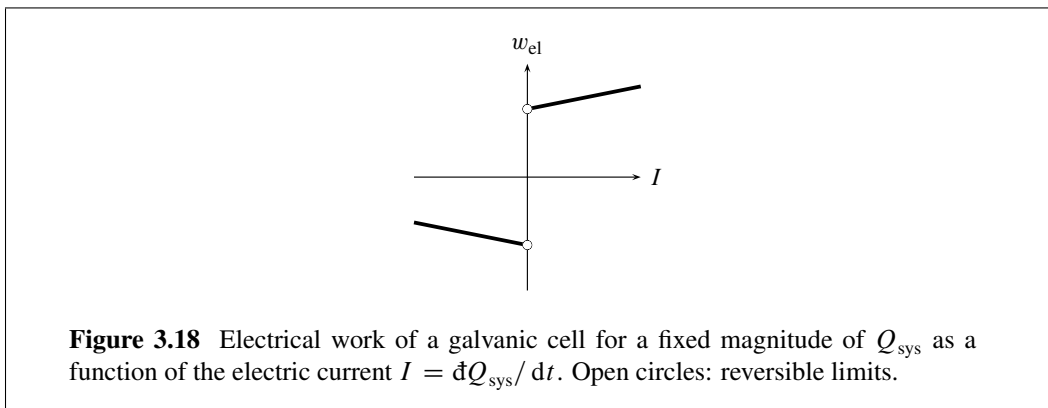

The figure shows E_{cell} as positive and \dot{Q}_{sys} as negative, so for this arrangement \dot{w}_{el} is negative.

When current passes through the cell, the work done is irreversible because the internal resistance causes energy dissipation. We can make this work approach a finite reversible limit by replacing the external resistor shown in Fig. 3.17(b) with an adjustable voltage source that we can use to control the cell potential E_{cell} and the current I . According to Eq. 3.8.7, E_{cell} is greater than $E_{\text{cell,eq}}$ when I is positive, and is less than $E_{\text{cell,eq}}$ when I is negative. This behavior is shown graphically in Fig. 3.18. In the limit as the electric current approaches zero from either direction and the external adjustable voltage approaches $E_{\text{cell,eq}}$, the electrical work approaches a reversible limit given by

$$\dot{w}_{\text{el, rev}} = E_{\text{cell, eq}} \dot{Q}_{\text{sys}} \quad (3.8.9)$$

Note that the electrical work is the least positive or most negative in the reversible limit.

Thus, unlike the dissipative work of stirring and electrical heating, electrical work with a galvanic cell has a nonzero reversible limit, as reflected by the difference in the appearance of Fig. 3.18 compared to Figs. 3.12 and 3.16. During irreversible electrical work of a galvanic cell, there is only *partial* dissipation of energy within the cell: the energy transferred across the boundary by the work can be partially recovered by returning the work coordinate Q_{sys} to its initial value.

On page 86 the observation was made that the work coordinate of work with a reversible limit is always a state function. Electrical work with a galvanic cell does not contradict this statement, because the work coordinate Q_{sys} is proportional to the extent of the cell reaction, a state function.

The thermodynamics of galvanic cells will be treated in detail in Chap. 14.

3.9 Irreversible Work and Internal Friction

Consider an irreversible adiabatic process of a closed system in which a work coordinate X changes at a finite rate along the path, starting and ending with equilibrium states. For a given initial state and a given change ΔX , the work is found to be less positive or more negative the more slowly is the rate of change of X . The work is least positive or most negative in the limit of infinite slowness—that is, the least work needs to be done on the

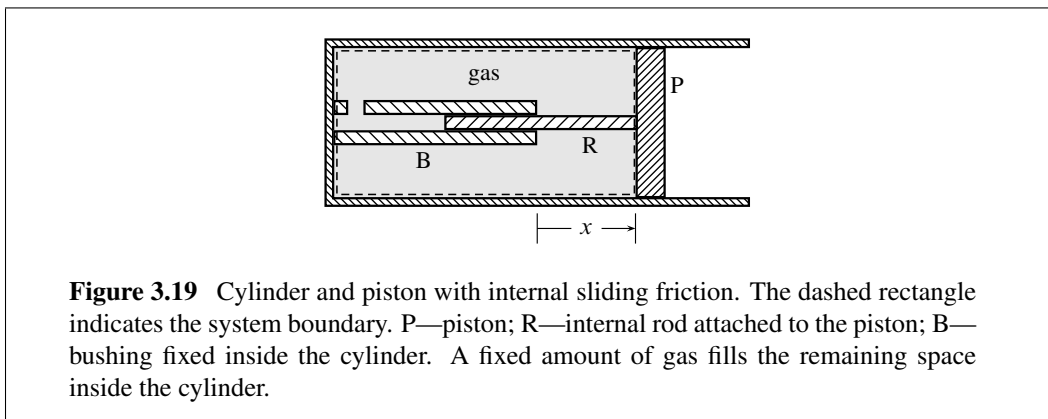

system, or the most work can be done by the system on the surroundings. This *minimal work principle* is illustrated in Sec. 3.5.5 for expansion work, Sec. 3.6 for work in a gravitational field, and Sec. 3.8.3 for electrical work with a galvanic cell.

Let w_{irr} be the work during an irreversible adiabatic process occurring at a finite rate, and w_0 be the adiabatic work for the same initial state and the same value of ΔX in the limit of infinite slowness. According to the minimal work principle, the difference $w_{\text{irr}} - w_0$ is positive. w_0 is the reversible work if the work has a reversible limit: compare Figs. 3.12(a) and 3.12(b) for shaft work with and without a reversible limit, respectively; also Figs. 3.16 and 3.18 for electrical work without and with a reversible limit.

Conceptually, we can attribute the positive value of $w_{\text{irr}} - w_0$ to *internal friction* that dissipates other forms of energy into thermal energy within the system. Internal friction is not involved when, for example, a temperature gradient causes heat to flow spontaneously across the system boundary, or an irreversible chemical reaction takes place spontaneously in a homogeneous phase. Nor is internal friction necessarily involved when positive work increases the thermal energy: during an infinitely slow adiabatic compression of a gas, the temperature and thermal energy increase but internal friction is absent—the process is reversible.

During a process with internal friction, energy dissipation can be either partial or complete. *Dissipative work*, such as the stirring work and electrical heating described in Sec. 3.7.1 and Sec. 3.8.2, is irreversible work with complete energy dissipation and no reversible limit. The final equilibrium state of an adiabatic process with dissipative work can also be reached by a path in which positive heat replaces the dissipative work. This is a special case of the minimal work principle.

As a model for work with partial energy dissipation, consider the gas-filled cylinder-and-piston device depicted in Fig. 3.19. This device has an obvious source of internal friction in the form of a rod sliding through a bushing. The *system* consists of the contents of the cylinder to the left of the piston, including the gas, the rod, and the bushing; the piston and cylinder wall are in the surroundings.

From Eq. 3.1.2, the energy transferred as work across the boundary of this system is

$$w = - \int_{x_1}^{x_2} F^{\text{sys}} dx \quad (3.9.1)$$

where x is the piston position and F^{sys} is the component in the direction of increasing x of the force exerted by the system on the surroundings at the moving boundary.

For convenience, we let V be the volume of the gas rather than that of the entire system. The relation between changes of V and x is $dV = A_s dx$ where A_s is the cross-section area of the cylinder. We also define p^{sys} to be the total force per unit area exerted by the system: $p^{\text{sys}} = F^{\text{sys}}/A_s$. With V replacing x as the work coordinate, Eq. 3.9.1 becomes

$$w = - \int_{V_1}^{V_2} (F^{\text{sys}}/A_s) dV = - \int_{V_1}^{V_2} p^{\text{sys}} dV \quad (3.9.2)$$

Equation 3.9.2 shows that a plot of p^{sys} as a function of V is an indicator diagram (Sec. 3.5.4), and that the work is equal to the negative of the area under the curve of this plot.

We can write the force F^{sys} as the sum of two contributions:²²

$$F^{\text{sys}} = pA_s + F_{\text{fric}} \quad (3.9.3)$$

Here p is the gas pressure, and F_{fric} is the force exerted on the rod due to internal friction with sign opposite to that of the piston velocity dx/dt . Substitution of this expression for F^{sys} in Eq. 3.9.2 gives

$$w = - \int_{V_1}^{V_2} p dV - \int_{V_1}^{V_2} (F_{\text{fric}}/A_s) dV \quad (3.9.4)$$

The first term on the right is the work of expanding or compressing the gas. The second term is the frictional work: $w_{\text{fric}} = - \int (F_{\text{fric}}/A_s) dV$. The frictional work is positive or zero, and represents the energy dissipated within the system by internal sliding friction.

The motion of the piston is controlled by an external force applied to the right face of the piston. The internal friction at the bushing can be either *lubricated friction* or *dry friction*.

If the contact between the rod and bushing is lubricated, a film of fluid lubricant separates the two solid surfaces and prevents them from being in direct contact. When the rod is in motion, the adjacent fluid layer moves with it, and the layer next to the bushing is stationary. Adjacent layers within the film move relative to one another. The result is shear stress (page 30) and a frictional force exerted on the moving rod. The frictional force depends on the lubricant viscosity, the area of the film, and the velocity of the rod. As the rod velocity approaches zero, the frictional force also approaches zero.

In the limit of infinite slowness F_{fric} and w_{fric} vanish, and the process is reversible with expansion work given by $w = - \int p dV$.

The situation is different when the piston moves at an appreciable finite rate. The frictional work w_{fric} is then positive. As a result, the irreversible work of expansion is less negative than the reversible work for the same volume increase, and the irreversible work of compression is more positive than the reversible work for the same volume decrease. These effects of piston velocity on the work are consistent with the minimal work principle.

The piston velocity, besides affecting the frictional force on the rod, has an effect on the force exerted by the gas on the piston as described in Sec. 3.4.1. At large finite velocities, this latter effect tends to further decrease F^{sys} during expansion and increase it during compression, and so is an additional contribution to internal friction. If turbulent flow is present within the system, that is also a contribution.

Figure 3.20 on the next page shows indicator diagrams for adiabatic expansion and

²²This equation assumes the gas pressure is uniform and a term for the acceleration of the rod is negligible.

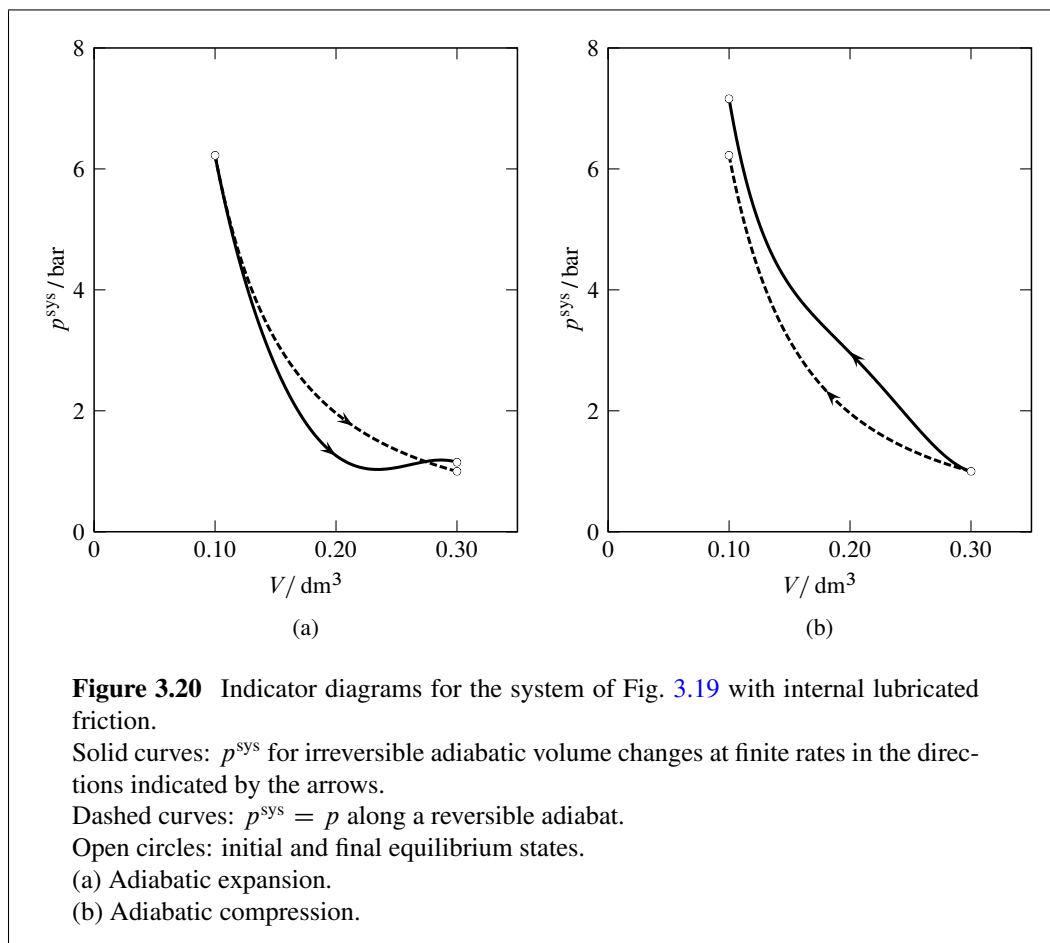

compression with internal lubricated friction. The solid curves are for irreversible processes at a constant piston velocity, and the dashed curves are for reversible processes with the same initial states as the irreversible processes. The areas under the curves confirm that the work for expansion is less negative along the irreversible path than along the reversible path, and that for compression the work is more positive along the irreversible path than along the reversible path.

Because of these differences in work, the final states of the irreversible processes have greater internal energies and higher temperatures and pressures than the final states of the reversible processes with the same volume change, as can be seen from the positions on the indicator diagrams of the points for the final equilibrium states. The overall change of state during the irreversible expansion or compression is the same for a path in which the reversible adiabatic volume change is followed by positive heat at constant volume. Since ΔU must be the same for both paths, the required heat equals $w_{\text{irr}} - w_{\text{rev}}$. This is not the value of the frictional work, because the thermal energy released by frictional work increases the gas pressure, making $w_{\text{irr}} - w_{\text{rev}}$ less than w_{fric} for expansion and greater than w_{fric} for compression. There seems to be no general method by which the energy dissipated by internal friction can be evaluated, and it would be even more difficult for an irreversible process with both work and heat.

Figure 3.21 on the next page shows the effect of the rate of change of the volume on the

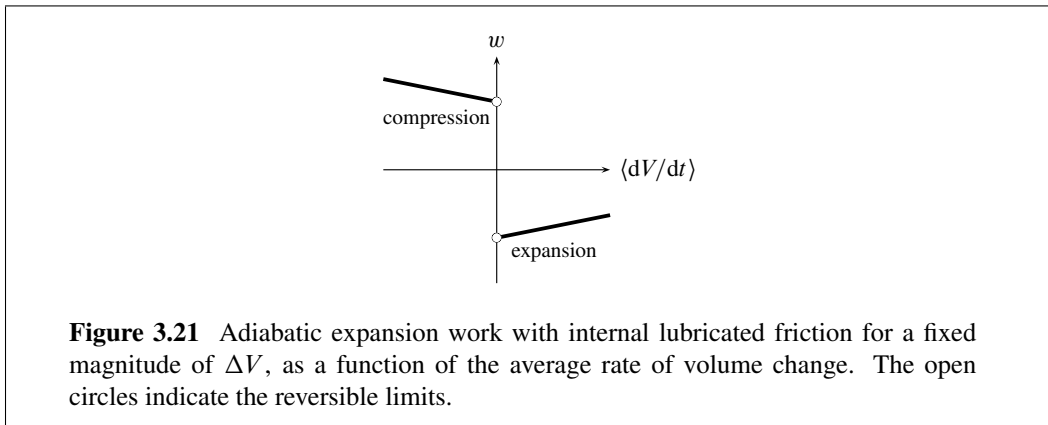

adiabatic work for a fixed magnitude of the volume change. Note that the work of expansion and the work of compression have opposite signs, and that it is only in the reversible limit that they have the same *magnitude*. The figure resembles Fig. 3.18 for electrical work of a galvanic cell with the horizontal axis reversed, and is typical of irreversible work with partial energy dissipation.

If the rod and bushing shown in Fig. 3.19 are *not* lubricated, so that their surfaces are in direct contact, the frictional force does not approach zero in the limit of zero piston velocity, unlike the behavior of lubricated friction. This dry friction is due to the roughness, on a microscopic scale, of the contacting surfaces. The frictional force of dry friction is typically independent of the area of contact and the rate at which the solid surfaces slide past one another.

The curves on indicator diagrams for adiabatic expansion and compression with internal dry friction are similar to the solid curves in Figs. 3.20(a) and 3.20(b), but their positions, unlike the curves for lubricated friction, change little as the average rate of volume change approaches zero. In the limit of infinite slowness, the work for a fixed magnitude of ΔV is negative for expansion and positive for compression, but the expansion work is smaller in magnitude than the compression work. The internal dry friction prevents the expansion process from being reversed as a compression process, regardless of piston velocity, and these processes are therefore irreversible.

3.10 Reversible and Irreversible Processes: Generalities

This section summarizes some general characteristics of processes in closed systems. Some of these statements will be needed to develop aspects of the second law in Chap. 4.

- Infinitesimal quantities of work during a process are calculated from an expression of the form $\dot{d}w = \sum_i Y_i dX_i$, where X_i is the work coordinate of kind of work i and Y_i is the conjugate work coefficient.
- The work coefficients and work coordinates of *reversible* work are state functions.
- Energy transferred across the boundary by work in a reversible process is fully recovered as work of the opposite sign in the reverse reversible process. It follows from the first law that heat is also fully recovered in the reverse process.

- When work occurs irreversibly at a finite rate, there is partial or complete dissipation of energy. The dissipation results in a change that could also be accomplished with positive heat, such as an increase of thermal energy within the system.
- Dissipative work is positive irreversible work with complete energy dissipation. The work coordinate for this type of work is not a state function. Examples are stirring work (Sec. 3.7.1) and the work of electrical heating (Sec. 3.8.2).
- If a process is carried out adiabatically and has a reversible limit, the work for a given initial equilibrium state and a given change in the work coordinate is least positive or most negative in the reversible limit. The dependence of work on the rate of change of the work coordinate is shown graphically for examples of dissipative work in Figs. 3.12(b) and 3.16, and for examples of work with partial energy dissipation in Figs. 3.12(a), 3.18, and 3.21.
- The number of independent variables needed to describe equilibrium states of a closed system is one greater than the number of independent work coordinates for reversible work.²³ Thus, we could choose the independent variables to be each of the work coordinates and in addition either the temperature or the internal energy.²⁴ The number of independent variables needed to describe a nonequilibrium state is greater (often *much* greater) than this.

Table 3.1 on the next page lists general formulas for various kinds of work, including those that were described in detail in Secs. 3.4–3.8.

²³If the system has internal adiabatic partitions that allow different phases to have different temperatures in equilibrium states, then the number of independent variables is equal to the number of work coordinates plus the number of independent temperatures.

²⁴There may be exceptions to this statement in special cases. For example, along the triple line of a pure substance the values of V and T , or of V and U , are not sufficient to determine the amounts in each of the three possible phases.

Table 3.1 Some kinds of work

Kind	Formula	Definitions
Linear mechanical work	$\delta w = F_x^{\text{sur}} dx$	F_x^{sur} = x -component of force exerted by surroundings dx = displacement in x direction
Shaft work	$\delta w = \tau_b d\vartheta$	τ_b = internal torque at boundary ϑ = angle of rotation
Expansion work	$\delta w = -p_b dV$	p_b = average pressure at moving boundary
Surface work of a flat surface	$\delta w = \gamma dA_s$	γ = surface tension, A_s = surface area
Stretching or compression of a rod or spring	$\delta w = F dl$	F = stress (positive for tension, negative for compression) l = length
Gravitational work	$\delta w = mg dh$	m = mass, h = height g = acceleration of free fall
Electrical work in a circuit	$\delta w = \Delta\phi \delta Q_{\text{sys}}$	$\Delta\phi$ = electric potential difference = $\phi_R - \phi_L$ δQ_{sys} = charge entering system at right
Electric polarization	$\delta w = \mathbf{E} \cdot d\mathbf{p}$	\mathbf{E} = electric field strength \mathbf{p} = electric dipole moment of system
Magnetization	$\delta w = \mathbf{B} \cdot d\mathbf{m}$	\mathbf{B} = magnetic flux density \mathbf{m} = magnetic dipole moment of system

PROBLEMS

An underlined problem number or problem-part letter indicates that the numerical answer appears in Appendix I.

- 3.1** Assume you have a metal spring that obeys Hooke's law: $F = c(l - l_0)$, where F is the force exerted on the spring of length l , l_0 is the length of the unstressed spring, and c is the spring constant. Find an expression for the work done on the spring when you reversibly compress it from length l_0 to a shorter length l' .

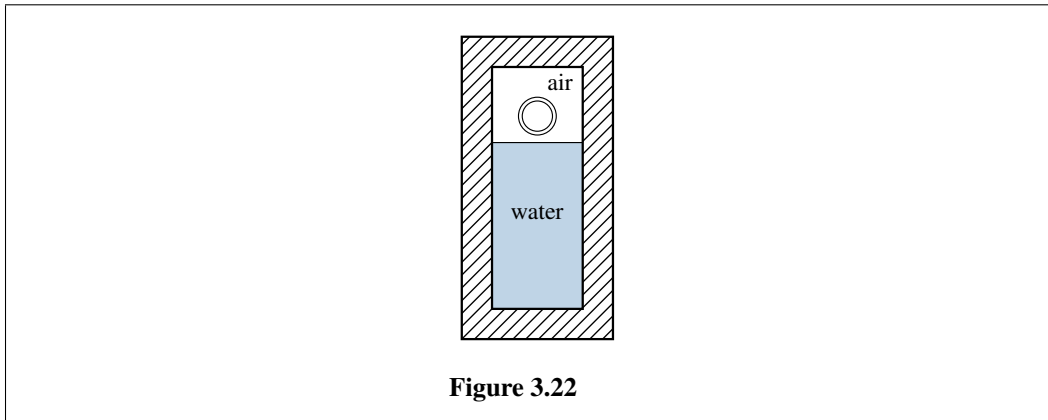

Figure 3.22

- 3.2** The apparatus shown in Fig. 3.22 consists of fixed amounts of water and air and an incompressible solid glass sphere (a marble), all enclosed in a rigid vessel resting on a lab bench. Assume the marble has an adiabatic outer layer so that its temperature cannot change, and that the walls of the vessel are also adiabatic.

Initially the marble is suspended above the water. When released, it falls through the air into the water and comes to rest at the bottom of the vessel, causing the water and air (but not the marble) to become slightly warmer. The process is complete when the system returns to an equilibrium state. The system energy change during this process depends on the frame of reference and on how the system is defined. ΔE_{sys} is the energy change in a lab frame, and ΔU is the energy change in a specified local frame.

For each of the following definitions of the system, give the *sign* (positive, negative, or zero) of both ΔE_{sys} and ΔU , and state your reasoning. Take the local frame for each system to be a center-of-mass frame.

- The system is the marble.
 - The system is the combination of water and air.
 - The system is the combination of water, air, and marble.
- 3.3** Figure 3.23 on the next page shows the initial state of an apparatus consisting of an ideal gas in a bulb, a stopcock, a porous plug, and a cylinder containing a frictionless piston. The walls are diathermal, and the surroundings are at a constant temperature of 300.0 K and a constant pressure of 1.00 bar.

When the stopcock is opened, the gas diffuses slowly through the porous plug, and the piston moves slowly to the right. The process ends when the pressures are equalized and the piston stops moving. The *system* is the gas. Assume that during the process the temperature throughout the system differs only infinitesimally from 300.0 K and the pressure on both sides of the piston differs only infinitesimally from 1.00 bar.

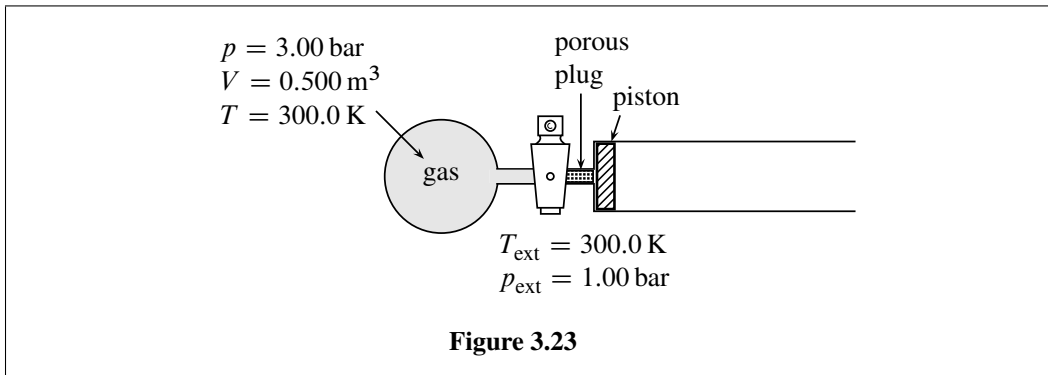

- (a) Which of these terms correctly describes the process: isothermal, isobaric, isochoric, reversible, irreversible?
- (b) Calculate q and w .

3.4 Consider a horizontal cylinder-and-piston device similar to the one shown in Fig. 3.5 on page 72. The piston has mass m . The cylinder wall is diathermal and is in thermal contact with a heat reservoir of temperature T_{ext} . The *system* is an amount n of an ideal gas confined in the cylinder by the piston.

The initial state of the system is an equilibrium state described by p_1 and $T = T_{\text{ext}}$. There is a constant external pressure p_{ext} , equal to twice p_1 , that supplies a constant external force on the piston. When the piston is released, it begins to move to the left to compress the gas. Make the idealized assumptions that (1) the piston moves with negligible friction; and (2) the gas remains practically uniform (because the piston is massive and its motion is slow) and has a practically constant temperature $T = T_{\text{ext}}$ (because temperature equilibration is rapid).

- (a) Describe the resulting process.
- (b) Describe how you could calculate w and q during the period needed for the piston velocity to become zero again.
- (c) Calculate w and q during this period for 0.500 mol gas at 300 K.

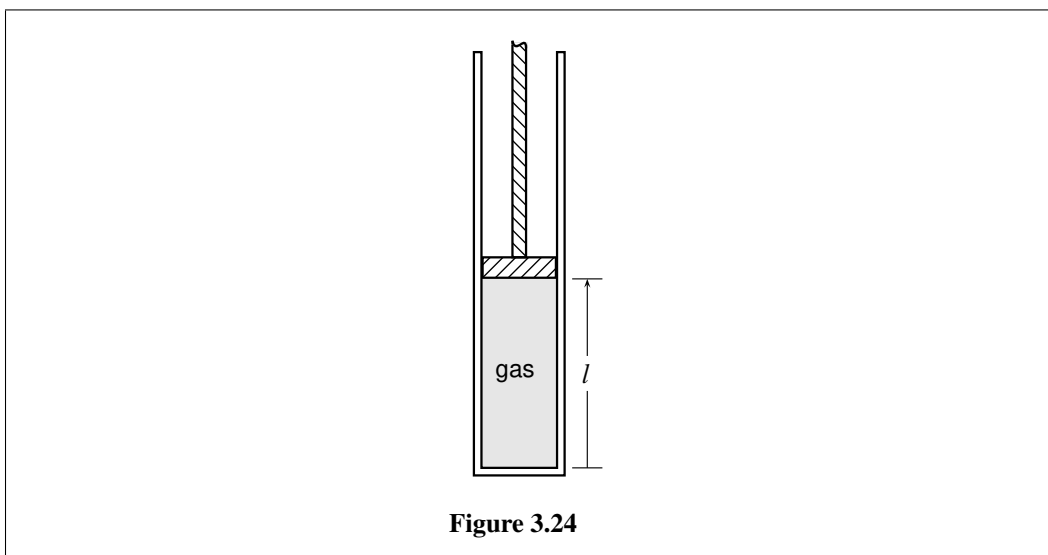

3.5 This problem is designed to test the assertion on page 60 that for typical thermodynamic processes in which the elevation of the center of mass changes, it is usually a good approximation to set w equal to w_{lab} . The cylinder shown in Fig. 3.24 on the preceding page has a vertical orientation, so the elevation of the center of mass of the gas confined by the piston changes as the piston slides up or down. The *system* is the gas. Assume the gas is nitrogen ($M = 28.0 \text{ g mol}^{-1}$) at 300 K, and initially the vertical length l of the gas column is one meter. Treat the nitrogen as an ideal gas, use a center-of-mass local frame, and take the center of mass to be at the midpoint of the gas column. Find the difference between the values of w and w_{lab} , expressed as a percentage of w , when the gas is expanded reversibly and isothermally to twice its initial volume.

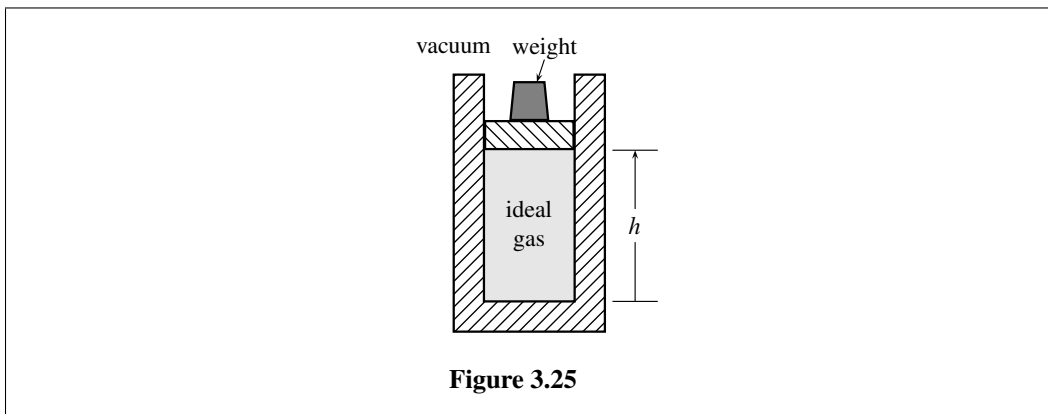
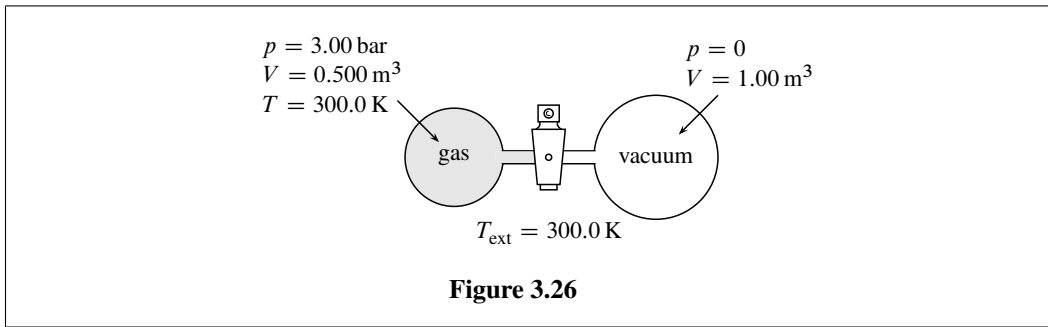

Figure 3.25

3.6 Figure 3.25 shows an ideal gas confined by a frictionless piston in a vertical cylinder. The *system* is the gas, and the boundary is adiabatic. The downward force on the piston can be varied by changing the weight on top of it.

- Show that when the system is in an equilibrium state, the gas pressure is given by $p = mgh/V$ where m is the combined mass of the piston and weight, g is the acceleration of free fall, and h is the elevation of the piston shown in the figure.
- Initially the combined mass of the piston and weight is m_1 , the piston is at height h_1 , and the system is in an equilibrium state with conditions p_1 and V_1 . The initial temperature is $T_1 = p_1 V_1 / nR$. Suppose that an additional weight is suddenly placed on the piston, so that m increases from m_1 to m_2 , causing the piston to sink and the gas to be compressed adiabatically and spontaneously. Pressure gradients in the gas, a form of friction, eventually cause the piston to come to rest at a final position h_2 . Find the final volume, V_2 , as a function of p_1 , p_2 , V_1 , and C_V . (Assume that the heat capacity of the gas, C_V , is independent of temperature.) Hint: The potential energy of the surroundings changes by $m_2 g \Delta h$; since the kinetic energy of the piston and weights is zero at the beginning and end of the process, and the boundary is adiabatic, the internal energy of the gas must change by $-m_2 g \Delta h = -m_2 g \Delta V / A_s = -p_2 \Delta V$.
- It might seem that by making the weight placed on the piston sufficiently large, V_2 could be made as close to zero as desired. Actually, however, this is not the case. Find expressions for V_2 and T_2 in the limit as m_2 approaches infinity, and evaluate V_2/V_1 in this limit if the heat capacity is $C_V = (3/2)nR$ (the value for an ideal monatomic gas at room temperature).

3.7 The solid curve in Fig. 3.7 on page 80 shows the path of a reversible adiabatic expansion or compression of a fixed amount of an ideal gas. Information about the gas is given in the figure caption. For compression along this path, starting at $V = 0.3000 \text{ dm}^3$ and $T = 300.0 \text{ K}$ and ending at $V = 0.1000 \text{ dm}^3$, find the final temperature to 0.1 K and the work.



- 3.8** Figure 3.26 shows the initial state of an apparatus containing an ideal gas. When the stopcock is opened, gas passes into the evacuated vessel. The *system* is the gas. Find q , w , and ΔU under the following conditions.
- (a) The vessels have adiabatic walls.
 - (b) The vessels have diathermal walls in thermal contact with a water bath maintained at 300. K, and the final temperature in both vessels is $T = 300$. K.
- 3.9** Consider a reversible process in which the shaft of system A in Fig. 3.11 makes one revolution in the direction of increasing ϑ . Show that the gravitational work of the weight is the same as the shaft work given by $w = mgr\Delta\vartheta$.

Table 3.2 Data for Problem 3.10. The values are from Joule’s 1850 paper^a and have been converted to SI units.

Properties of the paddle wheel apparatus:	
combined mass of the two lead weights	26.3182 kg
mass of water in vessel	6.04118 kg
mass of water with same heat capacity as paddle wheel, vessel, and lid ^b	0.27478 kg
Measurements during the experiment:	
number of times weights were wound up and released . . .	20
change of elevation of weights during each descent	−1.5898 m
final downward velocity of weights during descent	0.0615 m s ^{−1}
initial temperature in vessel	288.829 K
final temperature in vessel	289.148 K
mean air temperature	289.228 K

^aRef. [91], p. 67, experiment 5.

^bCalculated from the masses and specific heat capacities of the materials.

- 3.10** This problem guides you through a calculation of the mechanical equivalent of heat using data from one of James Joule’s experiments with a paddle wheel apparatus (see Sec. 3.7.2). The experimental data are collected in Table 3.2.

In each of his experiments, Joule allowed the weights of the apparatus to sink to the floor twenty times from a height of about 1.6 m, using a crank to raise the weights before each descent (see Fig. 3.14 on page 89). The paddle wheel was engaged to the weights through the roller and strings only while the weights descended. Each descent took about 26 seconds, and the entire experiment lasted 35 minutes. Joule measured the water temperature with a sensitive mercury-in-glass thermometer at both the start and finish of the experiment.

For the purposes of the calculations, define the *system* to be the combination of the vessel, its contents (including the paddle wheel and water), and its lid. All energies are measured in a lab frame. Ignore the small quantity of expansion work occurring in the experiment. It helps conceptually to think of the cellar room in which Joule set up his apparatus as being effectively isolated from the rest of the universe; then the only surroundings you need to consider for the calculations are the part of the room outside the system.

- Calculate the change of the gravitational potential energy E_p of the lead weights during each of the descents. For the acceleration of free fall at Manchester, England (where Joule carried out the experiment) use the value $g = 9.813 \text{ m s}^{-2}$. This energy change represents a decrease in the energy of the surroundings, and would be equal in magnitude and opposite in sign to the stirring work done on the system if there were no other changes in the surroundings.
- Calculate the kinetic energy E_k of the descending weights just before they reached the floor. This represents an increase in the energy of the surroundings. (This energy was dissipated into thermal energy in the surroundings when the weights came to rest on the floor.)
- Joule found that during each descent of the weights, friction in the strings and pulleys decreased the quantity of work performed on the system by 2.87 J. This quantity represents an increase in the thermal energy of the surroundings. Joule also considered the slight stretching of the strings while the weights were suspended from them: when the weights came to rest on the floor, the tension was relieved and the potential energy of the strings changed by -1.15 J . Find the total change in the energy of the surroundings during the entire experiment from all the effects described to this point. Keep in mind that the weights descended 20 times during the experiment.
- Data in Table 3.2 show that change of the temperature of the system during the experiment was

$$\Delta T = (289.148 - 288.829) \text{ K} = +0.319 \text{ K}$$

The paddle wheel vessel had no thermal insulation, and the air temperature was slightly warmer, so during the experiment there was a transfer of some heat into the system. From a correction procedure described by Joule, the temperature change that would have occurred if the vessel had been insulated is estimated to be $+0.317 \text{ K}$.

Use this information together with your results from part (c) to evaluate the work needed to increase the temperature of one gram of water by one kelvin. This is the “mechanical equivalent of heat” at the average temperature of the system during the experiment. (As mentioned on p. 87, Joule obtained the value 4.165 J based on all 40 of his experiments.)

- 3.11** Refer to the apparatus depicted in Fig. 3.1 on page 61. Suppose the mass of the external weight is $m = 1.50 \text{ kg}$, the resistance of the electrical resistor is $R_{\text{el}} = 5.50 \text{ k}\Omega$, and the acceleration of free fall is $g = 9.81 \text{ m s}^{-2}$. For how long a period of time will the external cell need to operate, providing an electric potential difference $|\Delta\phi| = 1.30 \text{ V}$, to cause the same change in the state of the system as the change when the weight sinks 20.0 cm without electrical work? Assume both processes occur adiabatically.

THE SECOND LAW

The second law of thermodynamics concerns entropy and the spontaneity of processes. This chapter discusses theoretical aspects and practical applications.

We have seen that the first law allows us to set up a balance sheet for energy changes during a process, but says nothing about why some processes occur spontaneously and others are impossible. The laws of physics explain some spontaneous changes. For instance, unbalanced forces on a body cause acceleration, and a temperature gradient at a diathermal boundary causes heat transfer. But how can we predict whether a phase change, a transfer of solute from one solution phase to another, or a chemical reaction will occur spontaneously under the existing conditions? The second law provides the principle we need to answer these and other questions—a general criterion for spontaneity in a closed system.

4.1 Types of Processes

Any conceivable process is either spontaneous, reversible, or impossible. These three possibilities were discussed in Sec. 3.2 and are summarized below.

- A *spontaneous* process is a real process that can actually take place in a finite time period.
- A *reversible* process is an imaginary, idealized process in which the system passes through a continuous sequence of equilibrium states. This sequence of states can be approached by a spontaneous process in the limit of infinite slowness, and so also can the reverse sequence of states.
- An *impossible* process is a change that cannot occur under the existing conditions, even in a limiting sense. It is also known as an unnatural or disallowed process. Sometimes it is useful to describe a hypothetical impossible process that we can imagine but that does not occur in reality. The second law of thermodynamics will presently be introduced with two such impossible processes.

The spontaneous processes relevant to chemistry are *irreversible*. An irreversible process is a spontaneous process whose reverse is an impossible process.

There is also the special category, of little interest to chemists, of purely mechanical processes. A purely mechanical process is a spontaneous process whose reverse is also spontaneous.

It is true that reversible processes and purely mechanical processes are idealized processes that cannot occur in practice, but a spontaneous process can be *practically* reversible if carried out sufficiently slowly, or *practically* purely mechanical if friction and temperature gradients are negligible. In that sense, they are not impossible processes. This book will reserve the term “impossible” for a process that cannot be approached by any spontaneous process, no matter how slowly or how carefully it is carried out.

4.2 Statements of the Second Law

A description of the **mathematical statement of the second law** is given in the box below.

$dS = \delta q/T_b$ for a reversible change of a closed system;
 $dS > \delta q/T_b$ for an irreversible change of a closed system;
 where S is an extensive state function, the entropy, and
 δq is an infinitesimal quantity of energy transferred
 by heat at a portion of the boundary where the
 thermodynamic temperature is T_b .

The box includes three distinct parts. First, there is the assertion that a property called **entropy**, S , is an extensive state function. Second, there is an equation for calculating the entropy change of a closed system during a reversible change of state: dS is equal to $\delta q/T_b$.¹ Third, there is a criterion for spontaneity: dS is greater than $\delta q/T_b$ during an irreversible change of state. The temperature T_b is a thermodynamic temperature, which will be defined in Sec. 4.3.4.

Each of the three parts is an essential component of the second law, but is somewhat abstract. What fundamental principle, based on experimental observation, may we take as the starting point to obtain them? Two principles are available, one associated with Clausius and the other with Kelvin and Planck. Both principles are equivalent statements of the second law. Each asserts that a certain kind of process is impossible, in agreement with common experience.

Consider the process depicted in Fig. 4.1(a) on the next page. The system is isolated, and consists of a cool body in thermal contact with a warm body. During the process, energy is transferred by means of heat from the cool to the warm body, causing the temperature of the cool body to decrease and that of the warm body to increase. Of course, this process is impossible; we never observe heat flow from a cooler to a warmer body. (In contrast, the reverse process, heat transfer from the warmer to the cooler body, is spontaneous and irreversible.) Note that this impossible process does not violate the first law, because energy is conserved.

Suppose we attempt to bring about the same changes in the two bodies by interposing a device of some sort between them, as depicted in Fig. 4.1(b). Here is how we would like the device to operate in the isolated system: Heat should flow from the cool body to the device, an equal quantity of heat should flow from the device to the warm body, and the final state

¹During a reversible process, the temperature usually has the same value T throughout the system, in which case we can simply write $dS = \delta q/T$. The equation $dS = \delta q/T_b$ allows for the possibility that in an equilibrium state the system has phases of different temperatures separated by internal adiabatic partitions.

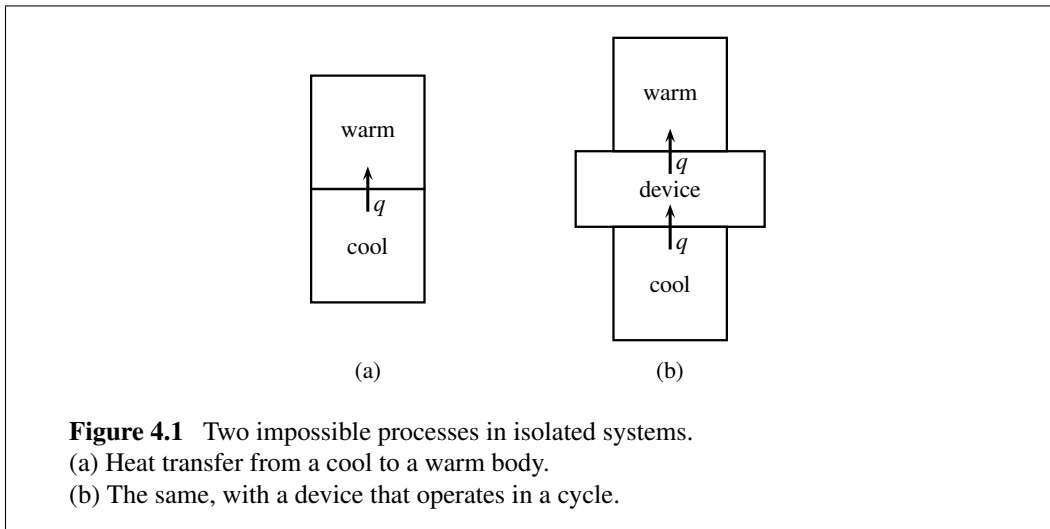

Figure 4.1 Two impossible processes in isolated systems.
 (a) Heat transfer from a cool to a warm body.
 (b) The same, with a device that operates in a cycle.

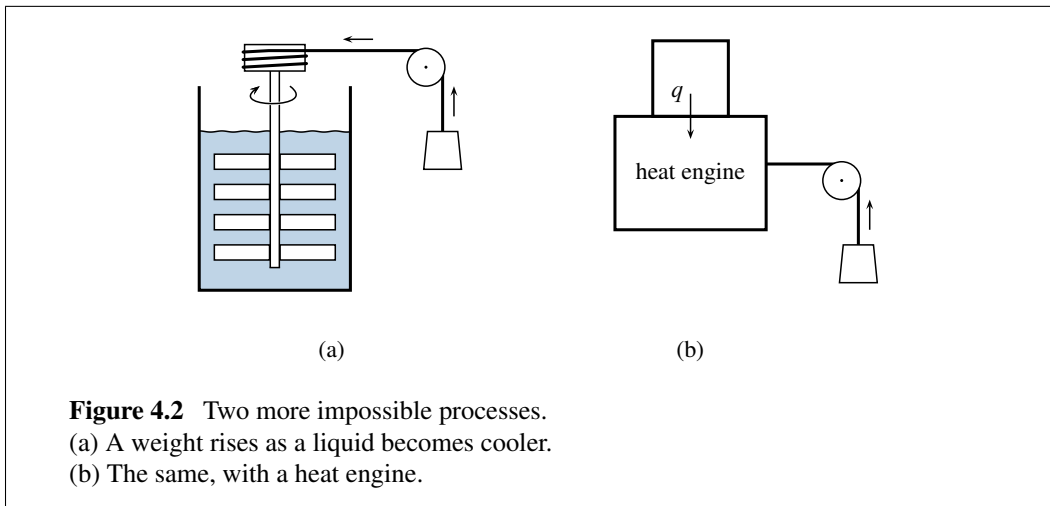

Figure 4.2 Two more impossible processes.
 (a) A weight rises as a liquid becomes cooler.
 (b) The same, with a heat engine.

of the device should be the same as its initial state. In other words, we want the device to transfer energy quantitatively by means of heat from the cool body to the warm body while operating in a *cycle*. If the device could do this, there would be no limit to the quantity of energy that could be transferred by heat, because after each cycle the device would be ready to repeat the process. But experience shows that *it is impossible to build such a device!* The proposed process of Fig. 4.1(b) is impossible even in the limit of infinite slowness.

The general principle was expressed by Rudolph Clausius² in the words: “Heat can never pass from a colder to a warmer body without some other change, connected therewith, occurring at the same time.” For use in the derivation to follow, the statement can be reworded as follows.

The Clausius statement of the second law: It is impossible to construct a device whose only effect, when it operates in a cycle, is heat transfer from a body to the device and the transfer by heat of an equal quantity of energy from the device to a warmer body.

Next consider the impossible process shown in Fig. 4.2(a). A Joule paddle wheel rotates

²Ref. [32], page 117.

in a container of water as a weight rises. As the weight gains potential energy, the water loses thermal energy and its temperature decreases. Energy is conserved, so there is no violation of the first law. This process is just the reverse of the Joule paddle-wheel experiment (Sec. 3.7.2) and its impossibility was discussed on page 68.

We might again attempt to use some sort of device operating in a cycle to accomplish the same overall process, as in Fig. 4.2(b). A closed system that operates in a cycle and does net work on the surroundings is called a **heat engine**. The heat engine shown in Fig. 4.2(b) is a special one. During one cycle, a quantity of energy is transferred by heat from a heat reservoir to the engine, and the engine performs an *equal* quantity of work on a weight, causing it to rise. At the end of the cycle, the engine has returned to its initial state. This would be a very desirable engine, because it could convert thermal energy into an equal quantity of useful mechanical work with no other effect on the surroundings.³ The engine could power a ship; it would use the ocean as a heat reservoir and require no fuel. Unfortunately, *it is impossible to construct such a heat engine!*

The principle was expressed by William Thomson (Lord Kelvin) in 1852 as follows: “It is impossible by means of inanimate material agency to derive mechanical effect from any portion of matter by cooling it below the temperature of the coldest of the surrounding objects.” Max Planck⁴ gave this statement: “It is impossible to construct an engine which will work in a complete cycle, and produce no effect except the raising of a weight and the cooling of a heat-reservoir.” For the purposes of this chapter, the principle can be reworded as follows.

The Kelvin–Planck statement of the second law: It is impossible to construct a heat engine whose only effect, when it operates in a cycle, is heat transfer from a heat reservoir to the engine and the performance of an equal quantity of work on the surroundings.

Both the Clausius statement and the Kelvin–Planck statement assert that certain processes, although they do not violate the first law, are nevertheless *impossible*.

These processes would not be impossible if we could control the trajectories of large numbers of individual particles. Newton’s laws of motion are invariant to time reversal. Suppose we could measure the position and velocity of each molecule of a macroscopic system in the final state of an irreversible process. Then, if we could somehow arrange at one instant to place each molecule in the same position with its velocity reversed, and if the molecules behaved classically, they would retrace their trajectories in reverse and we would observe the reverse “impossible” process.

The plan of the remaining sections of this chapter is as follows. In Sec. 4.3, a hypothetical device called a Carnot engine is introduced and used to prove that the two physical statements of the second law (the Clausius statement and the Kelvin–Planck statement) are equivalent, in the sense that if one is true, so is the other. An expression is also derived for the efficiency of a Carnot engine for the purpose of defining thermodynamic temperature. Section 4.4 combines Carnot cycles and the Kelvin–Planck statement to derive the existence and properties of the state function called entropy. Section 4.5 uses irreversible processes to complete the derivation of the mathematical statements given in the box on page 106, Sec. 4.6 describes some applications, and Sec. 4.7 is a summary. Finally, Sec. 4.8 briefly describes a microscopic, statistical interpretation of entropy.

³This hypothetical process is called “perpetual motion of the second kind.” ⁴Ref. [143], p. 89.

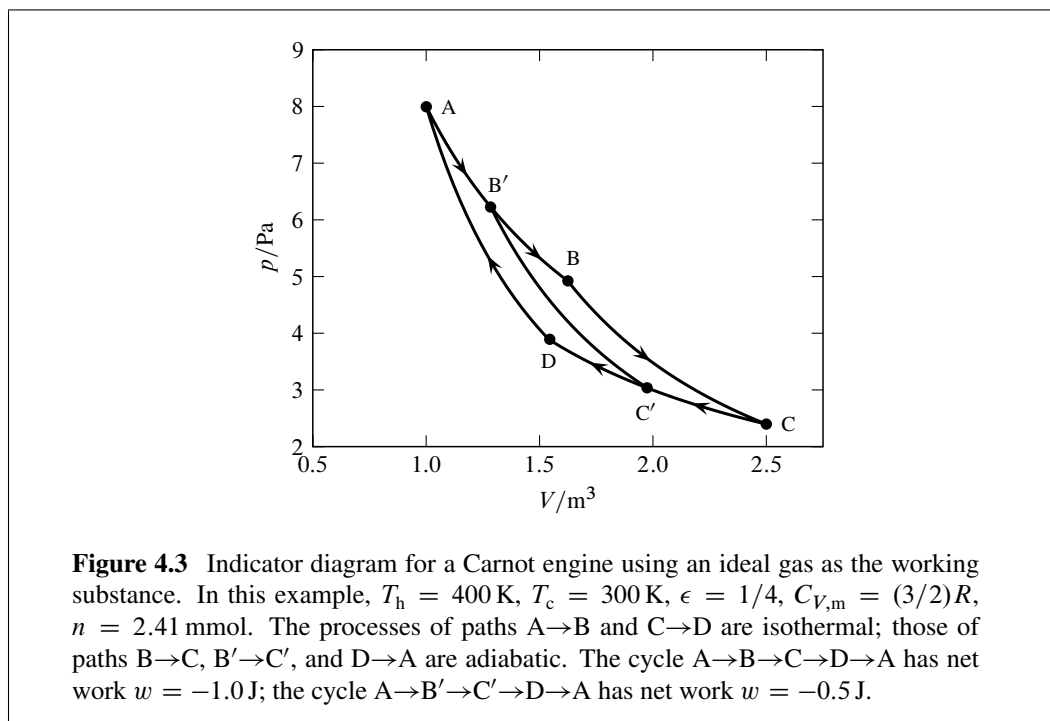

Carnot engines and Carnot cycles are admittedly outside the normal experience of chemists, and using them to derive the mathematical statement of the second law may seem arcane. G. N. Lewis and M. Randall, in their classic 1923 book *Thermodynamics and the Free Energy of Chemical Substances*,⁵ complained of the presentation of “‘cyclical processes’ limping about eccentric and not quite completed cycles.” There seems, however, to be no way to carry out a rigorous *general* derivation without invoking thermodynamic cycles. You may avoid the details by skipping Secs. 4.3–4.5. (Incidentally, the cycles described in these sections are complete!)

4.3 Concepts Developed with Carnot Engines

4.3.1 Carnot engines and Carnot cycles

A heat engine, as mentioned in Sec. 4.2, is a closed system that converts heat to work and operates in a cycle. A **Carnot engine** is a particular kind of heat engine, one that performs **Carnot cycles** with a working substance. A Carnot cycle has four reversible steps, alternating isothermal and adiabatic; see the examples in Figs. 4.3 and 4.4 in which the working substances are an ideal gas and H_2O , respectively.

The steps of a Carnot cycle are as follows. In this description, the *system* is the working substance.

Path $A \rightarrow B$: A quantity of heat q_h is transferred reversibly and isothermally from a heat reservoir (the “hot” reservoir) at temperature T_h to the system, also at temperature T_h . q_h is positive because energy is transferred into the system.

Path $B \rightarrow C$: The system undergoes a reversible adiabatic change that does work on the surroundings and reduces the system temperature to T_c .

⁵Ref. [110], p. 2.

BIOGRAPHICAL SKETCH

Sadi Carnot (1796–1832)

Sadi Carnot was the eldest son of Lazare Carnot, a famous French anti-royalist politician, one of Napoleon's generals with a great interest in mathematics. As a boy Sadi was shy and sensitive. He studied at the École Polytechnique, a training school for army engineers, and became an army officer.

Carnot is renowned for the one book he wrote: a treatise of 118 pages entitled *Reflections on the Motive Power of Fire and on Machines Fitted to Develop that Power*. This was published in 1824, when he was 28 and had retired from the army on half pay.

The book was written in a nontechnical style and went virtually unnoticed. Its purpose was to show how the efficiency of a steam engine could be improved, a very practical matter since French power technology lagged behind that of Britain at the time.^a

Notwithstanding the work of all kinds done by steam-engines, notwithstanding the satisfactory condition to which they have been brought today, their theory is very little understood, and the attempts to improve them are still directed almost by chance.

... We can easily conceive a multitude of machines fitted to develop the motive power of heat through the use of elastic fluids; but in whatever way we look at it, we should not lose sight of the following principles:

(1) The temperature of the fluid should be made as high as possible, in order to obtain a great fall of caloric, and consequently a large production of motive power.

(2) For the same reason the cooling should be

carried as far as possible.

(3) It should be so arranged that the passage of the elastic fluid from the highest to the lowest temperature should be due to increase of volume; that is, it should be so arranged that the cooling of the gas should occur spontaneously as the result of rarefaction [i.e., adiabatic expansion].

Carnot derived these principles from the abstract reversible cycle now called the Carnot cycle. He assumed the validity of the caloric theory (heat as an indestructible substance), which requires that the net heat in the cycle be zero, whereas today we would say that it is the net entropy change that is zero.

Despite the flaw of assuming that heat is conserved, a view which there is evidence he was beginning to doubt, his conclusion was valid that the efficiency of a reversible cycle operating between two fixed temperatures is independent of the working substance. He based his reasoning on the impossibility of the perpetual motion which would result by combining the cycle with the reverse of a more efficient cycle. Regarding Carnot's accomplishment, William Thomson (later Lord Kelvin) wrote:

Nothing in the whole range of Natural Philosophy is more remarkable than the establishment of general laws by such a process of reasoning.

A biographer described Carnot's personality as follows:^b

He was reserved, almost taciturn, with a hatred of any form of publicity. ... his friends all spoke of his underlying warmth and humanity. Passionately fond of music, he was an excellent violinist who preferred the classical Lully to the "moderns" of the time; he was devoted to literature and all the arts.

Carnot came down with scarlet fever and, while convalescing, died—probably of the cholera epidemic then raging. He was only 36.

Two years later his work was brought to public attention in a paper written by Émile Clapeyron (page 219), who used indicator diagrams to explain Carnot's ideas.

^aRef. [26]. ^bRef. [122], page x.

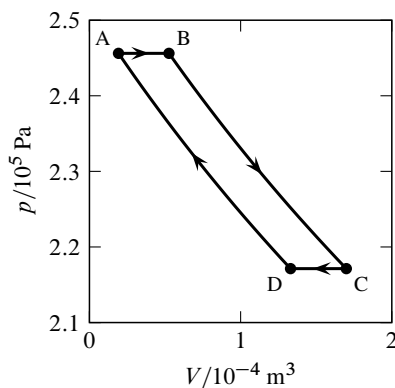

Figure 4.4 Indicator diagram for a Carnot engine using H_2O as the working substance. In this example, $T_h = 400 \text{ K}$, $T_c = 396 \text{ K}$, $\epsilon = 1/100$, $w = -1.0 \text{ J}$. In state A, the system consists of one mole of $\text{H}_2\text{O}(\text{l})$. The processes (all carried out reversibly) are: $A \rightarrow B$, vaporization of $2.54 \text{ mmol H}_2\text{O}$ at 400 K ; $B \rightarrow C$, adiabatic expansion, causing vaporization of an additional 7.68 mmol ; $C \rightarrow D$, condensation of 2.50 mmol at 396 K ; $D \rightarrow A$, adiabatic compression returning the system to the initial state.

Path $C \rightarrow D$: A quantity of heat q_c is transferred reversibly and isothermally from the system to a second heat reservoir (the “cold” reservoir) at temperature T_c . q_c is negative.

Path $D \rightarrow A$: The system undergoes a reversible adiabatic change in which work is done on the system, the temperature returns to T_h , and the system returns to its initial state to complete the cycle.

In one cycle, a quantity of heat is transferred from the hot reservoir to the system, a portion of this energy is transferred as heat to the cold reservoir, and the remainder of the energy is the negative net work w done on the surroundings. (It is the heat transfer to the cold reservoir that keeps the Carnot engine from being an impossible Kelvin–Planck engine.) Adjustment of the length of path $A \rightarrow B$ makes the magnitude of w as large or small as desired—note the two cycles with different values of w described in the caption of Fig. 4.3.

The Carnot engine is an idealized heat engine because its paths are reversible processes. It does not resemble the design of any practical steam engine. In a typical working steam engine, such as those once used for motive power in train locomotives and steamships, the cylinder contains an *open* system that undergoes the following irreversible steps in each cycle: (1) high-pressure steam enters the cylinder from a boiler and pushes the piston from the closed end toward the open end of the cylinder; (2) the supply valve closes and the steam expands in the cylinder until its pressure decreases to atmospheric pressure; (3) an exhaust valve opens to release the steam either to the atmosphere or to a condenser; (4) the piston returns to its initial position, driven either by an external force or by suction created by steam condensation.

The energy transfers involved in one cycle of a Carnot engine are shown schematically in Fig. 4.5(a) on the next page. When the cycle is reversed, as shown in Fig. 4.5(b), the device is called a **Carnot heat pump**. In each cycle of a Carnot heat pump, q_h is negative

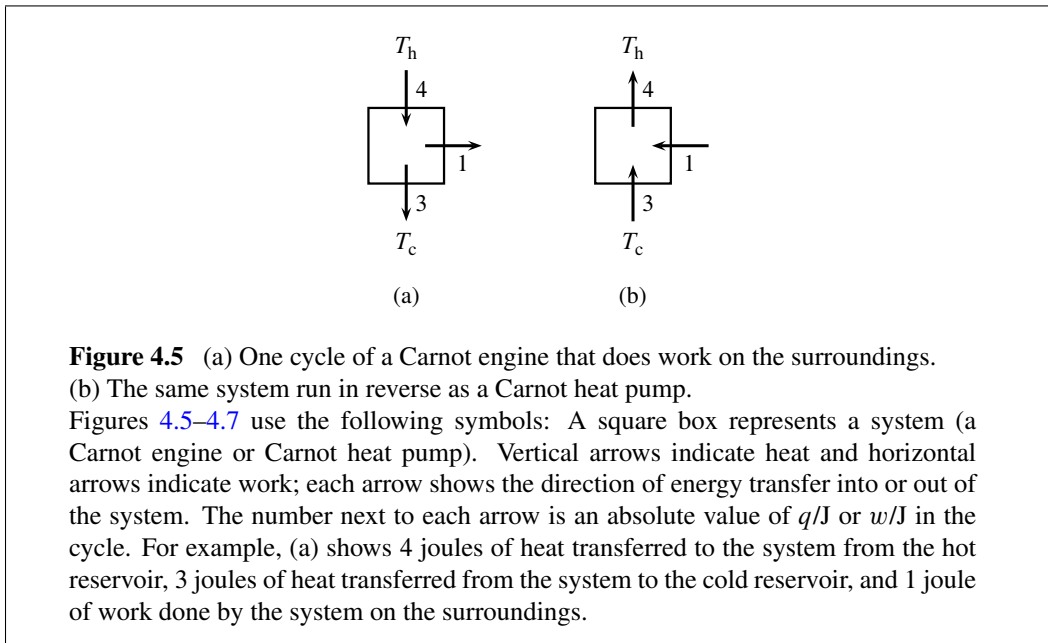

and q_c is positive. Since each step of a Carnot engine or Carnot heat pump is a reversible process, neither device is an impossible device.

4.3.2 The equivalence of the Clausius and Kelvin–Planck statements

We can use the logical tool of *reductio ad absurdum* to prove the equivalence of the Clausius and Kelvin–Planck statements of the second law.

Let us assume for the moment that the Clausius statement is incorrect, and that the device the Clausius statement claims is impossible (a “Clausius device”) is actually possible. If the Clausius device is possible, then we can combine one of these devices with a Carnot engine as shown in Fig. 4.6(a) on page 114. We adjust the cycles of the Clausius device and Carnot engine to transfer equal quantities of heat from and to the cold reservoir. The combination of the Clausius device and Carnot engine is a system. When the Clausius device and Carnot engine each performs one cycle, the system has performed one cycle as shown in Fig. 4.6(b). There has been a transfer of heat into the system and the performance of an equal quantity of work on the surroundings, with no other net change. This system is a heat engine that according to the Kelvin–Planck statement is impossible.

Thus, if the Kelvin–Planck statement is correct, it is impossible to operate the Clausius device as shown, and our provisional assumption that the Clausius statement is incorrect must be wrong. In conclusion, if the Kelvin–Planck statement is correct, then the Clausius statement must also be correct.

We can apply a similar line of reasoning to the heat engine that the Kelvin–Planck statement claims is impossible (a “Kelvin–Planck engine”) by seeing what happens if we assume this engine is actually possible. We combine a Kelvin–Planck engine with a Carnot heat pump, and make the work performed on the Carnot heat pump in one cycle equal to the work performed by the Kelvin–Planck engine in one cycle, as shown in Fig. 4.6(c). One cycle of the combined system, shown in Fig. 4.6(d), shows the system to be a device that

BIOGRAPHICAL SKETCH

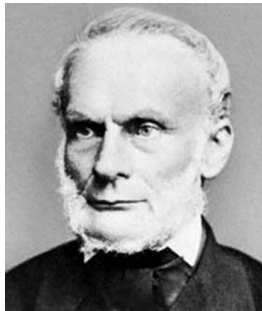
Rudolf Julius Emmanuel Clausius (1822–1888)

Rudolf Clausius was a German theoretical physicist who was the first to treat thermodynamics as a rigorous science, based on the earlier writings of Carnot and Clapeyron.

He was born in Köslin, Prussia, into a large family. His father was an educator and church minister.

Clausius was successively a professor at universities in Berlin, Zurich, Würzburg, and Bonn. In addition to thermodynamics, he did work on electrodynamic theory and the kinetic theory of gases.

Max Planck, referring to a time early in his own career, wrote:^a

One day, I happened to come across the treatises of Rudolf Clausius, whose lucid style and enlightening clarity of reasoning made an enormous impression on me, and I became deeply absorbed in his articles, with an ever increasing enthusiasm. I appreciated especially his exact formulation of the two Laws of Thermodynamics, and the sharp distinction which he was the first to establish between them.

Clausius based his exposition of the second law on the following principle that he published in 1854:^b

... it appears to me preferable to deduce the general form of the theorem immediately from the same principle which I have already employed in my former memoir, in order to demonstrate the modified theorem of Carnot.

This principle, upon which the whole of the following development rests, is as follows:—
Heat can never pass from a colder to a warmer body without some other change, connected

therewith, occurring at the same time. Everything we know concerning the interchange of heat between two bodies of different temperature confirms this; for heat everywhere manifests a tendency to equalize existing differences of temperature, and therefore to pass in a contrary direction, *i. e.* from warmer to colder bodies. Without further explanation, therefore, the truth of the principle will be granted.

In an 1865 paper, he introduced the symbol U for internal energy, and also coined the word *entropy* with symbol S :^c

We might call S the *transformational content* of the body, just as we termed the magnitude U its *thermal and ergonal content*. But as I hold it better to borrow terms for important magnitudes from the ancient languages, so that they may be adopted unchanged in all modern languages, I propose to call the magnitude S the *entropy* of the body, from the Greek word $\tau\rho\omicron\pi\eta$, *transformation*. I have intentionally formed the word *entropy* so as to be as similar as possible to the word *energy*; for the two magnitudes to be denoted by these words are so nearly allied in their physical meanings, that a certain similarity in designation appears to be desirable.

The 1865 paper concludes as follows, ending with Clausius's often-quoted summations of the first and second laws:^d

If for the entire universe we conceive the same magnitude to be determined, consistently and with due regard to all circumstances, which for a single body I have called *entropy*, and if at the same time we introduce the other and simpler conception of energy, we may express in the following manner the fundamental laws of the universe which correspond to the two fundamental theorems of the mechanical theory of heat.

1. *The energy of the universe is constant.*
2. *The entropy of the universe tends to a maximum.*

Clausius was a patriotic German. During the Franco-Prussian war of 1870–71, he undertook the leadership of an ambulance corps composed of Bonn students, was wounded in the leg during the battles, and suffered disability for the rest of his life.

^aRef. [144], page 16. ^bRef. [32], page 117. ^cRef. [33], page 357. ^dRef. [33], page 365.

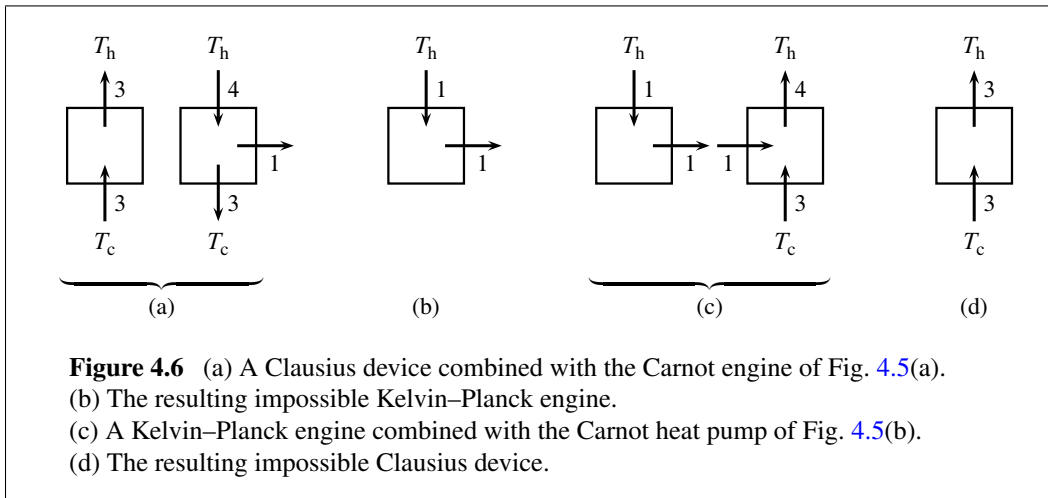

the Clausius statement says is impossible. We conclude that if the Clausius statement is correct, then the Kelvin–Planck statement must also be correct.

These conclusions complete the proof that the Clausius and Kelvin–Planck statements are equivalent: the truth of one implies the truth of the other. We may take either statement as the fundamental physical principle of the second law, and use it as the starting point for deriving the mathematical statement of the second law. The derivation will be taken up in Sec. 4.4.

4.3.3 The efficiency of a Carnot engine

Integrating the first-law equation $dU = \delta q + \delta w$ over one cycle of a Carnot engine, we obtain

$$0 = q_h + q_c + w \quad (4.3.1)$$

(one cycle of a Carnot engine)

The **efficiency** ϵ of a heat engine is defined as the fraction of the heat input q_h that is returned as net work done on the surroundings:

$$\epsilon \stackrel{\text{def}}{=} \frac{-w}{q_h} \quad (4.3.2)$$

By substituting for w from Eq. 4.3.1, we obtain

$$\epsilon = 1 + \frac{q_c}{q_h} \quad (4.3.3)$$

(Carnot engine)

Because q_c is negative, q_h is positive, and q_c is smaller in magnitude than q_h , the efficiency is less than one. The example shown in Fig. 4.5(a) is a Carnot engine with $\epsilon = 1/4$.

We will be able to reach an important conclusion regarding efficiency by considering a Carnot engine operating between the temperatures T_h and T_c , combined with a Carnot heat pump operating between the same two temperatures. The combination is a supersystem, and one cycle of the engine and heat pump is one cycle of the supersystem. We adjust the cycles of the engine and heat pump to produce zero net work for one cycle of the supersystem.

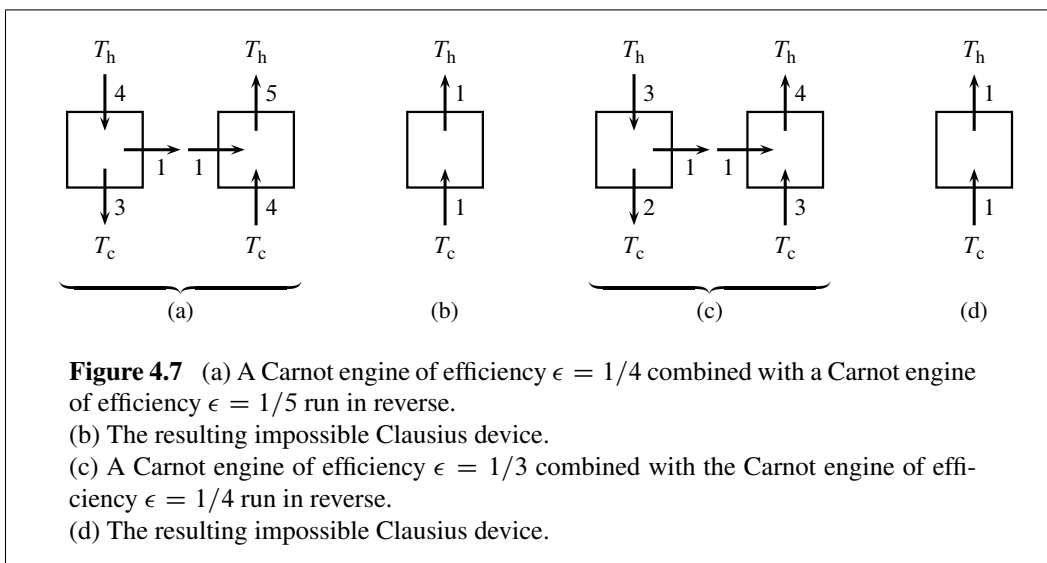

Could the efficiency of the Carnot engine be different from the efficiency the heat pump would have when run in reverse as a Carnot engine? If so, either the supersystem is an impossible Clausius device as shown in Fig. 4.7(b), or the supersystem operated in reverse (with the engine and heat pump switching roles) is an impossible Clausius device as shown in Fig. 4.7(d). We conclude that *all Carnot engines operating between the same two temperatures have the same efficiency*.

This is a good place to pause and think about the meaning of this statement in light of the fact that the steps of a Carnot engine, being reversible changes, cannot take place in a real system (Sec. 3.2). How can an engine operate that is not real? The statement is an example of a common kind of thermodynamic shorthand. To express the same idea more accurately, one could say that all heat engines (real systems) operating between the same two temperatures have the same *limiting* efficiency, where the limit is the reversible limit approached as the steps of the cycle are carried out more and more slowly. You should interpret any statement involving a reversible process in a similar fashion: a reversible process is an idealized *limiting* process that can be approached but never quite reached by a real system.

Thus, the efficiency of a Carnot engine must depend only on the values of T_c and T_h and not on the properties of the working substance. Since the efficiency is given by $\epsilon = 1 + q_c/q_h$, the ratio q_c/q_h must be a unique function of T_c and T_h only. To find this function for temperatures on the ideal-gas temperature scale, it is simplest to choose as the working substance an ideal gas.

An ideal gas has the equation of state $pV = nRT$. Its internal energy change in a closed system is given by $dU = C_V dT$ (Eq. 3.5.3), where C_V (a function only of T) is the heat capacity at constant volume. Reversible expansion work is given by $\delta w = -p dV$, which for an ideal gas becomes $\delta w = -(nRT/V) dV$. Substituting these expressions for

dU and δw in the first law, $dU = \delta q + \delta w$, and solving for δq , we obtain

$$\delta q = C_V dT + \frac{nRT}{V} dV \quad (4.3.4)$$

(ideal gas, reversible expansion work only)

Dividing both sides by T gives

$$\frac{\delta q}{T} = \frac{C_V dT}{T} + nR \frac{dV}{V} \quad (4.3.5)$$

(ideal gas, reversible expansion work only)

In the two adiabatic steps of the Carnot cycle, δq is zero. We obtain a relation among the volumes of the four labeled states shown in Fig. 4.3 by integrating Eq. 4.3.5 over these steps and setting the integrals equal to zero:

$$\text{Path B} \rightarrow \text{C}: \quad \int \frac{\delta q}{T} = \int_{T_h}^{T_c} \frac{C_V dT}{T} + nR \ln \frac{V_C}{V_B} = 0 \quad (4.3.6)$$

$$\text{Path D} \rightarrow \text{A}: \quad \int \frac{\delta q}{T} = \int_{T_c}^{T_h} \frac{C_V dT}{T} + nR \ln \frac{V_A}{V_D} = 0 \quad (4.3.7)$$

Adding these two equations (the integrals shown with limits cancel) gives the relation

$$nR \ln \frac{V_A V_C}{V_B V_D} = 0 \quad (4.3.8)$$

which we can rearrange to

$$\ln(V_B/V_A) = -\ln(V_D/V_C) \quad (4.3.9)$$

(ideal gas, Carnot cycle)

We obtain expressions for the heat in the two isothermal steps by integrating Eq. 4.3.4 with dT set equal to 0.

$$\text{Path A} \rightarrow \text{B}: \quad q_h = nRT_h \ln(V_B/V_A) \quad (4.3.10)$$

$$\text{Path C} \rightarrow \text{D}: \quad q_c = nRT_c \ln(V_D/V_C) \quad (4.3.11)$$

The ratio of q_c and q_h obtained from these expressions is

$$\frac{q_c}{q_h} = \frac{T_c}{T_h} \times \frac{\ln(V_D/V_C)}{\ln(V_B/V_A)} \quad (4.3.12)$$

By means of Eq. 4.3.9, this ratio becomes

$$\frac{q_c}{q_h} = -\frac{T_c}{T_h} \quad (4.3.13)$$

(Carnot cycle)

Accordingly, the unique function of T_c and T_h we seek that is equal to q_c/q_h is the ratio $-T_c/T_h$. The efficiency, from Eq. 4.3.3, is then given by

$$\epsilon = 1 - \frac{T_c}{T_h} \quad (4.3.14)$$

(Carnot engine)

In Eqs. 4.3.13 and 4.3.14, T_c and T_h are temperatures on the ideal-gas scale. As we have seen, these equations must be valid for *any* working substance; it is not necessary to specify as a condition of validity that the system is an ideal gas.

The ratio T_c/T_h is positive but less than one, so the efficiency is less than one as deduced earlier on page 114. This conclusion is an illustration of the Kelvin–Planck statement of the second law: A heat engine cannot have an efficiency of unity—that is, it cannot in one cycle convert all of the energy transferred by heat from a single heat reservoir into work. The example shown in Fig. 4.5 on page 112, with $\epsilon = 1/4$, must have $T_c/T_h = 3/4$ (e.g., $T_c = 300$ K and $T_h = 400$ K).

Keep in mind that a Carnot engine operates *reversibly* between two heat reservoirs. The expression of Eq. 4.3.14 gives the efficiency of this kind of idealized heat engine only. If any part of the cycle is carried out irreversibly, dissipation of mechanical energy will cause the efficiency to be *lower* than the theoretical value given by Eq. 4.3.14.

4.3.4 Thermodynamic temperature

The negative ratio q_c/q_h for a Carnot cycle depends only on the temperatures of the two heat reservoirs. Kelvin (1848) proposed that this ratio be used to establish an “absolute” temperature scale. The physical quantity now called **thermodynamic temperature** is defined by the relation

$$\frac{T_c}{T_h} = -\frac{q_c}{q_h} \quad (4.3.15)$$

(Carnot cycle)

That is, the ratio of the thermodynamic temperatures of two heat reservoirs is equal, by definition, to the ratio of the absolute quantities of heat transferred in the isothermal steps of a Carnot cycle operating between these two temperatures. In principle, a measurement of q_c/q_h during a Carnot cycle, combined with a defined value of the thermodynamic temperature of one of the heat reservoirs, can establish the thermodynamic temperature of the other heat reservoir. This defined value is provided by the triple point of H_2O ; its thermodynamic temperature is defined as exactly 273.16 kelvins (page 41).

Just as measurements with a gas thermometer in the limit of zero pressure establish the ideal-gas temperature scale (Sec. 2.3.6), the behavior of a heat engine in the reversible limit establishes the thermodynamic temperature scale. Note, however, that a reversible Carnot engine used as a “thermometer” to measure thermodynamic temperature is only a theoretical concept and not a practical instrument, since a completely-reversible process cannot occur in practice.

It is now possible to justify the statement in Sec. 2.3.6 that the ideal-gas temperature scale is proportional to the thermodynamic temperature scale. Both Eq. 4.3.13 and Eq. 4.3.15 equate the ratio T_c/T_h to $-q_c/q_h$; but whereas T_c and T_h refer in Eq. 4.3.13 to the *ideal-gas* temperatures of the heat reservoirs, in Eq. 4.3.15 they refer to the *thermodynamic* temperatures. This means that the ratio of the ideal-gas temperatures of two bodies is equal to the ratio of the thermodynamic temperatures of the same bodies, and therefore the two scales are proportional to one another. The proportionality factor is arbitrary, but must be unity if the same unit (e.g., kelvins) is used in both scales. Thus, as stated on page 42, the two scales expressed in kelvins are identical.

BIOGRAPHICAL SKETCH

William Thomson, Lord Kelvin (1824–1907)

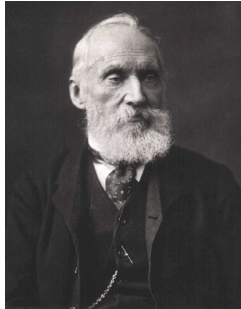

William Thomson was born in Belfast, Ireland. His mother died when he was six. In 1832 the family moved to Glasgow, Scotland, where his father had been appointed as the chair of mathematics at the University.

In 1845 Thomson was age 21. He had recently graduated from Cambridge University with high honors in mathematics, and was in Paris for discussions with French physicists and mathematicians. He had learned about Carnot's book from Clapeyron's 1834 paper but could not find a copy—no bookseller in Paris had even heard of it. Nevertheless, the information he had was sufficient for him to realize that Carnot's ideas would allow a thermodynamic temperature scale to be defined, one that does not depend on any particular gas.

The following year, Thomson became the Chair of Natural Philosophy at Glasgow University, largely through the influence of his father. He remained there until his retirement in 1899. His concept of a thermodynamic temperature scale, his best-known contribution to thermodynamics, was published in 1848.^a

Thomson published other papers on the theory of heat, but his ideas eventually changed as a result of hearing a presentation by James Joule at a meeting in Oxford in 1847. Joule was describing his experiments with the conversion of work to thermal energy by a paddle wheel. In a letter written to his nephew, J. T. Bottomley, Thomson wrote:^b

I made Joule's acquaintance at the Oxford meeting, and it quickly ripened into a life-long friendship.

I heard his paper read in the section, and felt strongly impelled at first to rise and say that it must be wrong because the true mechanical value of heat given, suppose in warm water, must, for small differences of temperature, be proportional to the square of its quantity. I knew from Carnot that this *must* be true (and it *is* true; only now I call it 'motivity,' to avoid clashing with Joule's 'mechanical value.')

But as I listened on and on, I saw that (though Carnot had vitally important truth, not to be abandoned) Joule had certainly a great truth and a great discovery, and a most important measurement to bring forward. So instead of rising with my objection to the meeting I waited till it was over, and said my say to Joule himself, at the end of the meeting. This made my first introduction to him. After that I had a long talk over the whole matter at one of the *conversaziones* of the Association, and we became fast friends from thenceforward.

The physicist Charles Everitt described Thomson's personality as follows:^c

Thomson was the kind of man who created all around him a sense of bustle and excitement. ... [He] was a man of violent enthusiasms. He would take up a subject, work at it furiously for a few weeks, throw out a string of novel ideas, and then inexplicably drop everything and pass on.

During his career, Thomson published more than 600 papers and received many honors. In addition to the theory of heat, his work included a dynamical theory of electricity and magnetism, and the invention of the mirror galvanometer used as the telegraph receiver for the first transatlantic submarine cables.

Thomson was the chief technical consultant for the initial cable projects. As a result of their success and his involvement in the construction of a global cable network, he became extremely wealthy and was knighted in 1866. In 1892 he became Baron Kelvin of Largs. "Kelvin" is the name of the river that flows past Glasgow University, "Largs" is the town where he had his home, and *kelvin* is now the SI unit of thermodynamic temperature.

^aRef. [96]. ^bRef. [17]. ^cRef. [53].

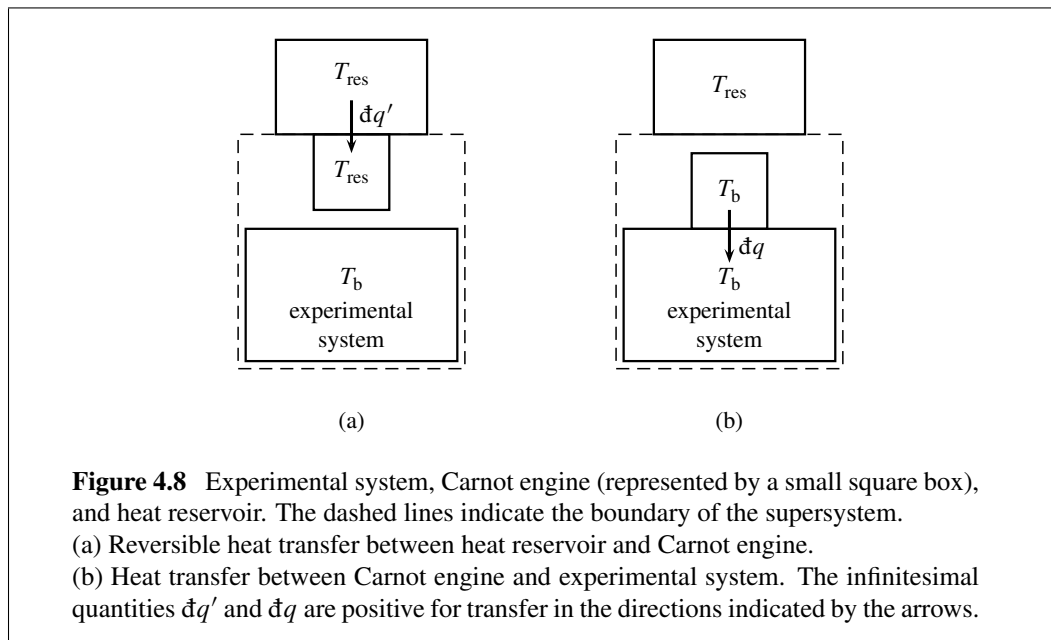

4.4 The Second Law for Reversible Processes

This section derives the existence and properties of the state function called entropy. To begin, a useful relation called the Clausius inequality will be derived.

4.4.1 The Clausius inequality

Consider an arbitrary cyclic process of a closed system. To avoid confusion, this system will be the “experimental system” and the process will be the “experimental process” or “experimental cycle.” There are no restrictions on the contents of the experimental system—it may have any degree of complexity whatsoever. The experimental process may involve more than one kind of work, phase changes and reactions may occur, there may be temperature and pressure gradients, constraints and external fields may be present, and so on. All parts of the process must be either irreversible or reversible, but not impossible.

We imagine that the experimental cycle is carried out in a special way that allows us to apply the Kelvin–Planck statement of the second law. The heat transferred across the boundary of the experimental system in each infinitesimal path element of the cycle is exchanged with a hypothetical Carnot engine. The combination of the experimental system and the Carnot engine is a closed *supersystem* (see Fig. 4.8). In the surroundings of the supersystem is a heat reservoir of arbitrary constant temperature T_{res} . By allowing the supersystem to exchange heat with only this single heat reservoir, we will be able to apply the Kelvin–Planck statement to a cycle of the supersystem.⁶

We assume that we are able to control changes of the work coordinates of the experimental system from the surroundings of the supersystem. We are also able to control the Carnot engine from these surroundings, for example by moving the piston of a cylinder-and-piston device containing the working substance. Thus the energy transferred by *work*

⁶This procedure is similar to ones described in Ref. [81], Sec. 16.1; Ref. [139], p. 36; Ref. [136], p. 21-23; Ref. [1], p. 68-69; and Ref. [132].

BIOGRAPHICAL SKETCH

Max Karl Ernst Ludwig Planck (1858–1947)

Max Planck, best known for his formulation of the quantum theory, had a passionate interest in thermodynamics in the early part of his career.

He was born in Kiel, Germany, where his father was a distinguished law professor. His family had a long tradition of conservatism, idealism, and excellence in scholarship.

As a youth, Planck had difficulty deciding between music and physics as a career, finally settling on physics. He acquired his interest in thermodynamics from studies with Hermann von Helmholtz and Gustav Kirchhoff and from the writings of Rudolf Clausius. His doctoral dissertation at the University of Munich (1879) was on the second law.

In 1897, Planck turned his papers on thermodynamics into a concise introductory textbook, *Treatise on Thermodynamics*. It went through at least seven editions and has been translated into English.^a

Concerning the second law he wrote:^b

Another controversy arose with relation to the question of the analogy between the passage of heat from a higher to a lower temperature and the sinking of a weight from a greater to a smaller height. I had emphasized the need for a sharp distinction between these two processes. . . . However, this theory of mine was contradicted by the view universally accepted in those days, and I just could not make my fellow physicists see it my way. . . .

A consequence of this point of view [held by others] was that the assumption of irreversibility for proving the Second Law of Thermodynamics

was declared to be unessential; furthermore, the existence of an absolute zero of temperature was disputed, on the ground that for temperature, just as for height, only differences can be measured. It is one of the most painful experiences of my entire scientific life that I have but seldom—in fact, I might say, never—succeeded in gaining universal recognition for a new result, the truth of which I could demonstrate by a conclusive, albeit only theoretical proof. This is what happened this time, too. All my sound arguments fell on deaf ears.

Planck became an associate professor of physics at the University of Kiel. In 1889 he succeeded Kirchhoff as Professor at Berlin University. By the end of the following year, at the age of 42, he had worked out his quantum theory to explain the experimental facts of blackbody radiation, a formulation that started a revolution in physics. He was awarded the 1918 Nobel Prize in Physics “in recognition of the services he rendered to the advancement of Physics by his discovery of energy quanta.”

Planck was reserved and only enjoyed socializing with persons of similar rank. He was a gifted pianist with perfect pitch, and enjoyed hiking and climbing well into his old age. He was known for his fairness, integrity, and moral force.

He endured many personal tragedies in his later years. His first wife died after 22 years of a happy marriage. His elder son was killed in action during World War I. Both of his twin daughters died in childbirth.

Planck openly opposed the Nazi persecution of Jews but remained in Germany during World War II out of a sense of duty. The war brought further tragedy: his house in Berlin was destroyed by bombs, and his second son was implicated in the failed 1944 attempt to assassinate Hitler and was executed by the Gestapo. Planck and his second wife escaped the bombings by hiding in the woods and sleeping in haystacks in the countryside. They were rescued by American troops in May, 1945.

^aRef. [143]. ^bRef. [144], pages 29–30.

across the boundary of the experimental system, and the work required to operate the Carnot engine, is exchanged with the surroundings of the supersystem.

During each stage of the experimental process with nonzero heat, we allow the Carnot engine to undergo many infinitesimal Carnot cycles with infinitesimal quantities of heat and work. In one of the isothermal steps of each Carnot cycle, the Carnot engine is in thermal contact with the heat reservoir, as depicted in Fig. 4.8(a). In this step the Carnot engine has the same temperature as the heat reservoir, and reversibly exchanges heat $\delta q'$ with it. The sign convention is that $\delta q'$ is positive if heat is transferred in the direction of the arrow, from the heat reservoir to the Carnot engine.

In the other isothermal step of the Carnot cycle, the Carnot engine is in thermal contact with the experimental system at a portion of the system's boundary as depicted in Fig. 4.8(b). The Carnot engine now has the same temperature, T_b , as the experimental system at this part of the boundary, and exchanges heat with it. The heat δq is positive if the transfer is into the experimental system.

The relation between temperatures and heats in the isothermal steps of a Carnot cycle is given by Eq. 4.3.15. From this relation we obtain, for one infinitesimal Carnot cycle, the relation $T_b/T_{\text{res}} = \delta q/\delta q'$, or

$$\delta q' = T_{\text{res}} \frac{\delta q}{T_b} \quad (4.4.1)$$

After many infinitesimal Carnot cycles, the experimental cycle is complete, the experimental system has returned to its initial state, and the Carnot engine has returned to its initial state in thermal contact with the heat reservoir. Integration of Eq. 4.4.1 around the experimental cycle gives the net heat entering the supersystem during the process:

$$q' = T_{\text{res}} \oint \frac{\delta q}{T_b} \quad (4.4.2)$$

The integration here is over each path element of the experimental process and over each surface element of the boundary of the experimental system.

Keep in mind that the value of the cyclic integral $\oint(\delta q/T_b)$ depends only on the path of the experimental cycle, that this process can be reversible or irreversible, and that T_{res} is a positive constant.

In this experimental cycle, could the net heat q' transferred to the supersystem be positive? If so, the net work would be negative (to make the internal energy change zero) and the supersystem would have converted heat from a single heat reservoir completely into work, a process the Kelvin–Planck statement of the second law says is impossible. Therefore it is impossible for q' to be positive, and from Eq. 4.4.2 we obtain the relation

$$\oint \frac{\delta q}{T_b} \leq 0 \quad (4.4.3)$$

(cyclic process of a closed system)

This relation is known as the **Clausius inequality**. It is valid only if the integration is taken around a cyclic path in a direction with nothing but reversible and irreversible changes—the path must not include an impossible change, such as the reverse of an irreversible change. The Clausius inequality says that if a cyclic path meets this specification, it is impossible for the cyclic integral $\oint(\delta q/T_b)$ to be positive.

If the entire experimental cycle is adiabatic (which is only possible if the process is reversible), the Carnot engine is not needed and Eq. 4.4.3 can be replaced by $\oint(\delta q/T_b) = 0$.

4.4.2 Using reversible processes to define the entropy

Next let us investigate a *reversible* nonadiabatic process of the closed experimental system. Starting with a particular equilibrium state A, we carry out a reversible process in which there is a net flow of heat into the system, and in which δq is either positive or zero in each path element. The final state of this process is equilibrium state B. Let δq_{rev} denote an infinitesimal quantity of heat in a reversible process. If δq_{rev} is positive or zero during the process, then the integral $\int_A^B (\delta q_{\text{rev}}/T_b)$ must be positive. In this case the Clausius inequality tells us that if the system completes a cycle by returning from state B back to state A by a different path, the integral $\int_B^A (\delta q_{\text{rev}}/T_b)$ for this second path must be negative. Therefore the change B→A cannot be carried out by any *adiabatic* process.

Any reversible process can be carried out in reverse. Thus, by reversing the reversible nonadiabatic process, it is possible to change the state from B to A by a reversible process with a net flow of heat out of the system and with δq_{rev} either negative or zero in each element of the reverse path. In contrast, the absence of an adiabatic path from B to A means that it is impossible to carry out the change A→B by a reversible adiabatic process.

The general rule, then, is that whenever equilibrium state A of a closed system can be changed to equilibrium state B by a reversible process with finite “one-way” heat (i.e., the flow of heat is either entirely into the system or else entirely out of it), it is impossible for the system to change from either of these states to the other by a reversible adiabatic process.

A simple example will relate this rule to experience. We can increase the temperature of a liquid by allowing heat to flow reversibly into the liquid. It is impossible to duplicate this change of state by a reversible process without heat—that is, by using some kind of reversible work. The reason is that reversible work involves the change of a work coordinate that brings the system to a different final state. There is nothing in the rule that says we can’t increase the temperature *irreversibly* without heat, as we can for instance with stirring work.

States A and B can be arbitrarily close. We conclude that *every equilibrium state of a closed system has other equilibrium states infinitesimally close to it that are inaccessible by a reversible adiabatic process*. This is Carathéodory’s principle of adiabatic inaccessibility.⁷

Next let us consider the reversible adiabatic processes that *are* possible. To carry out a reversible adiabatic process, starting at an initial equilibrium state, we use an adiabatic boundary and slowly vary one or more of the work coordinates. A certain final temperature will result. It is helpful in visualizing this process to think of an N -dimensional space in which each axis represents one of the N independent variables needed to describe an equilibrium state. A point in this space represents an equilibrium state, and the path of a reversible process can be represented as a curve in this space.

A suitable set of independent variables for equilibrium states of a closed system of uniform temperature consists of the temperature T and each of the work coordinates (Sec. 3.10). We can vary the work coordinates independently while keeping the boundary adiabatic, so the paths for possible reversible adiabatic processes can connect any arbitrary combinations of work coordinate values.

⁷Constantin Carathéodory in 1909 combined this principle with a mathematical theorem (Carathéodory’s theorem) to deduce the existence of the entropy function. The derivation outlined here avoids the complexities of that mathematical treatment and leads to the same results.

There is, however, the additional dimension of temperature in the N -dimensional space. Do the paths for possible reversible adiabatic processes, starting from a common initial point, lie in a *volume* in the N -dimensional space? Or do they fall on a *surface* described by T as a function of the work coordinates? If the paths lie in a volume, then every point in a volume element surrounding the initial point must be accessible from the initial point by a reversible adiabatic path. This accessibility is precisely what Carathéodory's principle of adiabatic inaccessibility denies. Therefore, the paths for all possible reversible adiabatic processes with a common initial state must lie on a unique *surface*. This is an $(N - 1)$ -dimensional hypersurface in the N -dimensional space, or a curve if N is 2. One of these surfaces or curves will be referred to as a **reversible adiabatic surface**.

Now consider the initial and final states of a reversible process with one-way heat (i.e., each nonzero infinitesimal quantity of heat δq_{rev} has the same sign). Since we have seen that it is impossible for there to be a reversible *adiabatic* path between these states, the points for these states must lie on different reversible adiabatic surfaces that do not intersect anywhere in the N -dimensional space. Consequently, there is an infinite number of nonintersecting reversible adiabatic surfaces filling the N -dimensional space. (To visualize this for $N = 3$, think of a flexed stack of paper sheets; each sheet represents a different reversible adiabatic surface in three-dimensional space.) A reversible, nonadiabatic process with one-way heat is represented by a path beginning at a point on one reversible adiabatic surface and ending at a point on a different surface. If q is positive, the final surface lies on one side of the initial surface, and if q is negative, the final surface is on the opposite side.

The existence of reversible adiabatic surfaces is the justification for defining a new state function S , the **entropy**. S is specified to have the same value everywhere on one of these surfaces, and a different, unique value on each different surface. In other words, the reversible adiabatic surfaces are surfaces of *constant entropy* in the N -dimensional space. The fact that the surfaces fill this space without intersecting ensures that S is a state function for equilibrium states, because any point in this space represents an equilibrium state and also lies on a single reversible adiabatic surface with a definite value of S .

We know the entropy function must exist, because the reversible adiabatic surfaces exist. For instance, Fig. 4.9 on the next page shows a family of these surfaces for a closed system of a pure substance in a single phase. In this system, N is equal to 2, and the surfaces are two-dimensional curves. Each curve is a contour of constant S . At this stage in the derivation, our assignment of values of S to the different curves is entirely arbitrary.

How can we assign a unique value of S to each reversible adiabatic surface? We can order the values by letting a reversible process with *positive* one-way heat, which moves the point for the state to a new surface, correspond to an *increase* in the value of S . Negative one-way heat will then correspond to decreasing S . We can assign an arbitrary value to the entropy on one particular reversible adiabatic surface. (The third law of thermodynamics is used for this purpose—see Sec. 6.1.) Then all that is needed to assign a value of S to each equilibrium state is a formula for evaluating the *difference* in the entropies of any two surfaces.

Consider a reversible process with *positive* one-way heat that changes the system from state A to state B. The path for this process must move the system from a reversible adiabatic surface of a certain entropy to a different surface of greater entropy. An example is the path A→B in Fig. 4.10(a) on the next page. (The adiabatic surfaces in this figure are actually two-dimensional curves.) As before, we combine the experimental system with a Carnot engine to form a supersystem that exchanges heat with a single heat reservoir of constant

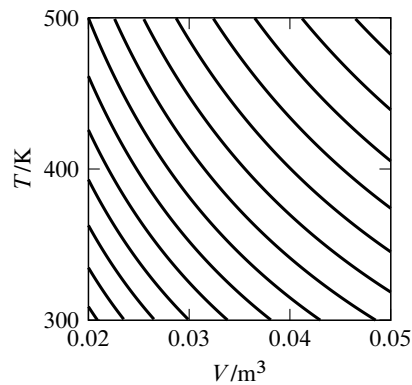

Figure 4.9 A family of reversible adiabatic curves (two-dimensional reversible adiabatic surfaces) for an ideal gas with V and T as independent variables. A reversible adiabatic process moves the state of the system along a curve, whereas a reversible process with positive heat moves the state from one curve to another above and to the right. The curves are calculated for $n = 1$ mol and $C_{V,m} = (3/2)R$. Adjacent curves differ in entropy by 1 J K^{-1} .

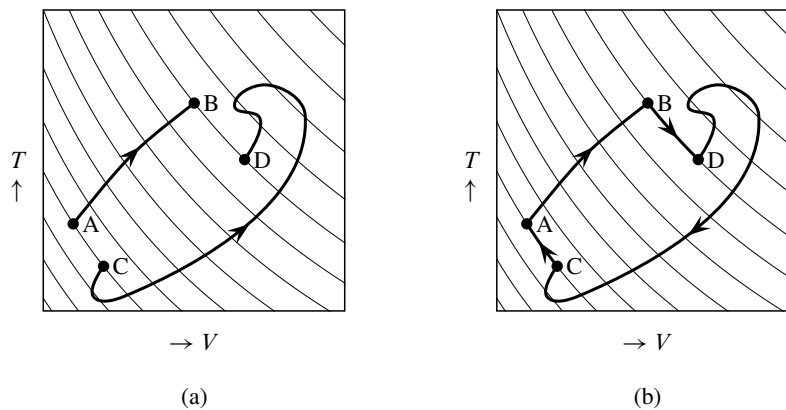

Figure 4.10 Reversible paths in V - T space. The thin curves are reversible adiabatic surfaces.

(a) Two paths connecting the same pair of reversible adiabatic surfaces.

(b) A cyclic path.

temperature T_{res} . The net heat entering the supersystem, found by integrating Eq. 4.4.1, is

$$q' = T_{\text{res}} \int_A^B \frac{\delta q_{\text{rev}}}{T_b} \quad (4.4.4)$$

and it is positive.

Suppose the same experimental system undergoes a second reversible process, not necessarily with one-way heat, along a different path connecting the same pair of reversible adiabatic surfaces. This could be path $C \rightarrow D$ in Fig. 4.10(a). The net heat entering the

supersystem during this second process is q'' :

$$q'' = T_{\text{res}} \int_C^D \frac{\delta q_{\text{rev}}}{T_b} \quad (4.4.5)$$

We can then devise a *cycle* of the supersystem in which the experimental system undergoes the reversible path $A \rightarrow B \rightarrow D \rightarrow C \rightarrow A$, as shown in Fig. 4.10(b). Step $A \rightarrow B$ is the first process described above, step $D \rightarrow C$ is the reverse of the second process described above, and steps $B \rightarrow D$ and $C \rightarrow A$ are reversible and adiabatic. The net heat entering the supersystem in the cycle is $q' - q''$. In the reverse cycle the net heat is $q'' - q'$. In both of these cycles the heat is exchanged with a single heat reservoir; therefore, according to the Kelvin–Planck statement, neither cycle can have positive net heat. Therefore q' and q'' must be equal, and Eqs. 4.4.4 and 4.4.5 then show the integral $\int (\delta q_{\text{rev}}/T_b)$ has the same value when evaluated along either of the reversible paths from the lower to the higher entropy surface.

Note that since the second path ($C \rightarrow D$) does not necessarily have one-way heat, it can take the experimental system through any sequence of intermediate entropy values, provided it starts at the lower entropy surface and ends at the higher. Furthermore, since the path is reversible, it can be carried out in reverse resulting in reversal of the signs of ΔS and $\int (\delta q_{\text{rev}}/T_b)$.

It should now be apparent that a satisfactory formula for defining the entropy change of a reversible process in a closed system is

$$\Delta S = \int \frac{\delta q_{\text{rev}}}{T_b} \quad (4.4.6)$$

(reversible process,
closed system)

This formula satisfies the necessary requirements: it makes the value of ΔS positive if the process has positive one-way heat, negative if the process has negative one-way heat, and zero if the process is adiabatic. It gives the same value of ΔS for any reversible change between the same two reversible adiabatic surfaces, and it makes the sum of the ΔS values of several consecutive reversible processes equal to ΔS for the overall process.

In Eq. 4.4.6, ΔS is the entropy change when the system changes from one arbitrary equilibrium state to another. If the change is an infinitesimal path element of a reversible process, the equation becomes

$$dS = \frac{\delta q_{\text{rev}}}{T_b} \quad (4.4.7)$$

(reversible process,
closed system)

In Eq. 4.4.7, the quantity $1/T_b$ is called an *integrating factor* for δq_{rev} , a factor that makes the product $(1/T_b) \delta q_{\text{rev}}$ be an exact differential and the infinitesimal change of a state function. The quantity c/T_b , where c is any nonzero constant, would also be a satisfactory integrating factor; so the definition of entropy, using $c=1$, is actually one of an infinite number of possible choices for assigning values to the reversible adiabatic surfaces.

4.4.3 Alternative derivation of entropy as a state function

The Clausius inequality $\oint (\delta q/T_b) \leq 0$ (Eq. 4.4.3) can be used to show, by a more direct route than in the preceding section, that $(\delta q_{\text{rev}}/T_b)$ is an exact differential during a

reversible process of a closed system. When we equate dS to this differential, as in Eq. 4.4.7, the entropy S can be shown to be a state function.

The proof uses the fact that when a reversible process is reversed and the system passes through the same continuous sequence of equilibrium states in reverse order, the heat δq_{rev} in each infinitesimal step changes its sign but not its magnitude (Sec. 3.2.1). As a result, the integral $\int (\delta q_{\text{rev}}/T_b)$ changes its sign but not its magnitude when the process is reversed.

Consider an arbitrary reversible cyclic process of a closed system. Could the cyclic integral $\oint (\delta q_{\text{rev}}/T_b)$ for this process be *positive*? No, that is impossible according to the Clausius inequality. Could the cyclic integral be *negative*? No, because in this case $\oint (\delta q_{\text{rev}}/T_b)$ for the reverse cycle is positive, which is also impossible. Thus the value of the cyclic integral for a reversible cyclic process must be *zero*:

$$\oint \frac{\delta q_{\text{rev}}}{T_b} = 0 \quad (4.4.8)$$

(reversible cyclic process
of a closed system)

Let A and B be any two equilibrium states. Let path 1 and path 2 be two arbitrary but different reversible paths starting at state A and ending at state B, and let path 3 be the path from state B to state A that is the reverse of path 2. When the system changes from state A to state B along path 1, and then changes back to state A along path 3, it has undergone a reversible cyclic process. From Eq. 4.4.8, the sum of the integrals of $(\delta q_{\text{rev}}/T_b)$ along paths 1 and 3 is zero. The integral of $(\delta q_{\text{rev}}/T_b)$ along path 3 has the same magnitude and opposite sign of the integral of $(\delta q_{\text{rev}}/T_b)$ along path 2. Therefore the integral $\int_A^B (\delta q_{\text{rev}}/T_b)$ must have the same value along paths 1 and 2. The result would be the same for a reversible cycle using any other two paths from state A to state B. We conclude that the value of $(\delta q_{\text{rev}}/T_b)$ integrated over a reversible path between any two equilibrium states depends only on the initial and final states and not on the path; that is, $(\delta q_{\text{rev}}/T_b)$ is an exact differential as defined on page 53.

When we equate dS to $(\delta q_{\text{rev}}/T_b)$, the entropy change along a reversible path from any initial equilibrium state A to any final equilibrium state B is given by

$$\Delta S_{A \rightarrow B} = S_B - S_A = \int_A^B dS = \int_A^B \frac{\delta q_{\text{rev}}}{T_b} \quad (4.4.9)$$

Since the value of $\int_A^B (\delta q_{\text{rev}}/T_b)$ depends only on the initial and final states A and B, so also does the value of $\Delta S_{A \rightarrow B}$. If a value of S is assigned to a reference state, Eq. 4.4.9 in principle allows the value of S to be evaluated for any other equilibrium state of the system. Each value of S then depends only on the state and not on the past or future history of the system. Therefore, by the definition in Sec. 2.4.1 on page 47, the entropy is a state function.

4.4.4 Some properties of the entropy

It is not difficult to show that the entropy of a closed system in an equilibrium state is an *extensive* property. Suppose a system of uniform temperature T is divided into two closed subsystems A and B. When a reversible infinitesimal change occurs, the entropy changes of the subsystems are $dS_A = \delta q_A/T$ and $dS_B = \delta q_B/T$ and of the system $dS = \delta q_{\text{rev}}/T$.

But δq_{rev} is the sum of δq_A and δq_B , which gives $dS = dS_A + dS_B$. Thus, the entropy changes are additive, so that entropy must be extensive: $S = S_A + S_B$.⁸

How can we evaluate the entropy of a particular equilibrium state of the system? We must assign an arbitrary value to one state and then evaluate the entropy change along a reversible path from this state to the state of interest using $\Delta S = \int (\delta q_{\text{rev}}/T_b)$.

We may need to evaluate the entropy of a *nonequilibrium* state. To do this, we imagine imposing hypothetical internal constraints that change the nonequilibrium state to a constrained equilibrium state with the same internal structure. Some examples of such internal constraints were given in Sec. 2.4.4, and include rigid adiabatic partitions between phases of different temperature and pressure, semipermeable membranes to prevent transfer of certain species between adjacent phases, and inhibitors to prevent chemical reactions.

We assume that we can, in principle, impose or remove such constraints reversibly without heat, so there is no entropy change. If the nonequilibrium state includes macroscopic internal motion, the imposition of internal constraints involves negative reversible work to bring moving regions of the system to rest.⁹ If the system is nonuniform over its extent, the internal constraints will partition it into practically-uniform regions whose entropy is additive. The entropy of the nonequilibrium state is then found from $\Delta S = \int (\delta q_{\text{rev}}/T_b)$ using a reversible path that changes the system from an equilibrium state of known entropy to the constrained equilibrium state with the same entropy as the state of interest. This procedure allows every possible state (at least conceptually) to have a definite value of S .

4.5 The Second Law for Irreversible Processes

We know that during a reversible process of a closed system, each infinitesimal entropy change dS is equal to $\delta q/T_b$ and the finite change ΔS is equal to the integral $\int (\delta q/T_b)$ —but what can we say about dS and ΔS for an *irreversible* process?

The derivation of this section will show that for an infinitesimal irreversible change of a closed system, dS is greater than $\delta q/T_b$, and for an entire irreversible process ΔS is greater than $\int (\delta q/T_b)$. That is, the *equalities* that apply to a reversible process are replaced, for an irreversible process, by *inequalities*.

The derivation begins with irreversible processes that are adiabatic, and is then extended to irreversible processes in general.

4.5.1 Irreversible adiabatic processes

Consider an arbitrary irreversible adiabatic process of a closed system starting with a particular initial state A. The final state B depends on the path of this process. We wish to investigate the sign of the entropy change $\Delta S_{A \rightarrow B}$. Our reasoning will depend on whether or not there is work during the process.

If there is work along any infinitesimal path element of the irreversible adiabatic process ($\delta w \neq 0$), we know from experience that this work would be different if the work coordinate or coordinates were changing at a different rate, because energy dissipation from

⁸The argument is not quite complete, because we have not shown that when each subsystem has an entropy of zero, so does the entire system. The zero of entropy will be discussed in Sec. 6.1.

⁹This concept amounts to defining the entropy of a state with macroscopic internal motion to be the same as the entropy of a state with the same internal structure but without the motion, i.e., the same state frozen in time. By this definition, ΔS for a purely mechanical process (Sec. 3.2.4) is zero.

internal friction would then be different. In the limit of infinite slowness, an adiabatic process with initial state A and the same change of work coordinates would become reversible, and the net work and final internal energy would differ from those of the irreversible process. Because the final state of the reversible adiabatic process is different from B, there is no reversible adiabatic path with work between states A and B.

All states of a reversible process, including the initial and final states, must be equilibrium states. There is therefore a conceptual difficulty in considering reversible paths between two states if either of these states are nonequilibrium states. In such a case we will assume that the state has been replaced by a constrained equilibrium state of the same entropy, as described in Sec. 4.4.4.

If, on the other hand, there is no work along any infinitesimal path element of the irreversible adiabatic process ($\delta w = 0$), the process is taking place at constant internal energy U in an *isolated* system. A reversible limit cannot be reached without heat or work (page 66). Thus any reversible adiabatic change from state A would require work, causing a change of U and preventing the system from reaching state B by any reversible adiabatic path.

So regardless of whether or not an irreversible adiabatic process $A \rightarrow B$ involves work, there is no *reversible* adiabatic path between A and B. The only reversible paths between these states must be *nonadiabatic*. It follows that the entropy change $\Delta S_{A \rightarrow B}$, given by the value of $\delta q_{\text{rev}}/T_b$ integrated over a reversible path from A to B, cannot be zero.

Next we ask whether $\Delta S_{A \rightarrow B}$ could be negative. In each infinitesimal path element of the irreversible adiabatic process $A \rightarrow B$, δq is zero and the integral $\int_A^B (\delta q/T_b)$ along the path of this process is zero. Suppose the system completes a cycle by returning along a different, reversible path from state B back to state A. The Clausius inequality (Eq. 4.4.3) tells us that in this case the integral $\int_B^A (\delta q_{\text{rev}}/T_b)$ along the reversible path cannot be positive. But this integral for the reversible path is equal to $-\Delta S_{A \rightarrow B}$, so $\Delta S_{A \rightarrow B}$ cannot be negative.

We conclude that because the entropy change of the irreversible adiabatic process $A \rightarrow B$ cannot be zero, and it cannot be negative, it must be *positive*.

In this derivation, the initial state A is arbitrary and the final state B is reached by an irreversible adiabatic process. If the two states are only infinitesimally different, then the change is infinitesimal. Thus for an infinitesimal change that is irreversible and adiabatic, dS must be *positive*.

4.5.2 Irreversible processes in general

To treat an irreversible process of a closed system that is nonadiabatic, we proceed as follows. As in Sec. 4.4.1, we use a Carnot engine for heat transfer across the boundary of the experimental system. We move the boundary of the supersystem of Fig. 4.8 so that the supersystem now includes the experimental system, the Carnot engine, and a heat reservoir of constant temperature T_{res} , as depicted in Fig. 4.11 on the next page.

During an irreversible change of the experimental system, the Carnot engine undergoes many infinitesimal cycles. During each cycle, the Carnot engine exchanges heat $\delta q'$ at temperature T_{res} with the heat reservoir and heat δq at temperature T_b with the experimental system, as indicated in the figure. We use the sign convention that $\delta q'$ is positive if heat is transferred to the Carnot engine, and δq is positive if heat is transferred to the experimental system, in the directions of the arrows in the figure.

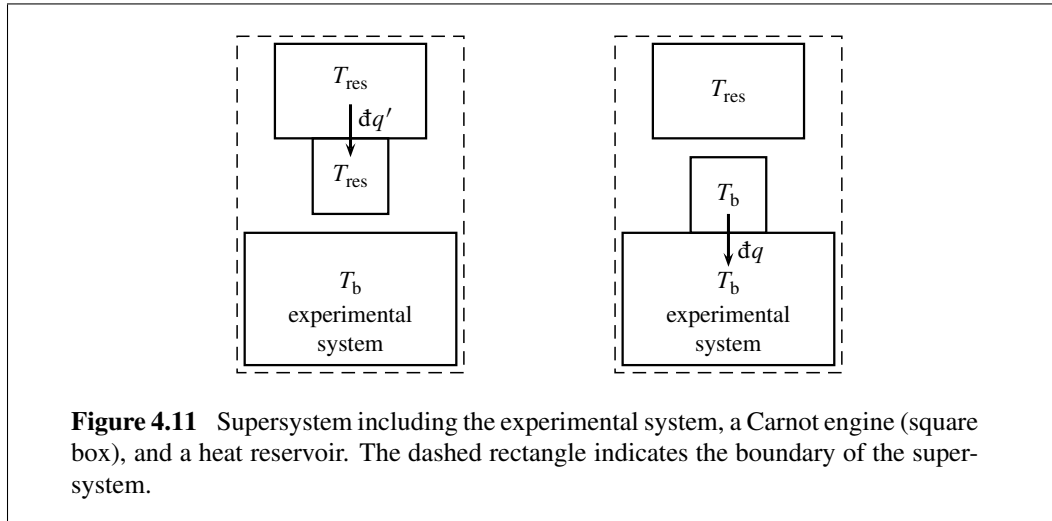

The supersystem exchanges work, but not heat, with its surroundings. (The work involves the Carnot engine, but not necessarily the experimental system.) During one infinitesimal cycle of the Carnot engine, the net entropy change of the Carnot engine is zero, the entropy change of the experimental system is dS , the heat transferred between the Carnot engine and the experimental system is $\dot{d}q$, and the heat transferred between the heat reservoir and the Carnot engine is given by $\dot{d}q' = T_{\text{res}} \dot{d}q / T_b$ (Eq. 4.4.1). The heat transfer between the heat reservoir and Carnot engine is reversible, so the entropy change of the heat reservoir is

$$dS_{\text{res}} = -\frac{\dot{d}q'}{T_{\text{res}}} = -\frac{\dot{d}q}{T_b} \quad (4.5.1)$$

The entropy change of the supersystem is the sum of the entropy changes of its parts:

$$dS_{\text{ss}} = dS + dS_{\text{res}} = dS - \frac{\dot{d}q}{T_b} \quad (4.5.2)$$

The process within the supersystem is adiabatic and includes an irreversible change within the experimental system, so according to the conclusions of Sec. 4.5.1, dS_{ss} is positive. Equation 4.5.2 then shows that dS , the infinitesimal entropy change during the irreversible change of the experimental system, must be greater than $\dot{d}q / T_b$:

$$dS > \frac{\dot{d}q}{T_b} \quad (4.5.3) \quad (\text{irreversible change, closed system})$$

This relation includes the case of an irreversible *adiabatic* change, because it shows that if $\dot{d}q$ is zero, dS is greater than zero.

By integrating both sides of Eq. 4.5.3 between the initial and final states of the irreversible process, we obtain a relation for the finite entropy change corresponding to many infinitesimal cycles of the Carnot engine:

$$\Delta S > \int \frac{\dot{d}q}{T_b} \quad (4.5.4) \quad (\text{irreversible process, closed system})$$

4.6 Applications

The lengthy derivation in Secs. 4.3–4.5 is based on the Kelvin–Planck statement describing the impossibility of converting completely into work the energy transferred into the system by heat from a single heat reservoir. The derivation has now given us all parts of the mathematical statement of the second law shown in the box on page 106. The mathematical statement includes an equality, $dS = \delta q_{\text{rev}}/T_b$, that applies to an infinitesimal *reversible* change, and an inequality, $dS > \delta q/T_b$, that applies to an infinitesimal *irreversible* change. It is convenient to combine the equality and inequality in a single relation that is a general mathematical statement of the second law:

$$dS \geq \frac{\delta q}{T_b} \quad (4.6.1)$$

(irrev, closed system)

The inequality refers to an irreversible change and the equality to a reversible change, as indicated by the notation $\overset{\text{irrev}}{\text{rev}}$ in the conditions of validity. The integrated form of this relation is

$$\Delta S \geq \int \frac{\delta q}{T_b} \quad (4.6.2)$$

(irrev, closed system)

During a reversible process, the states are equilibrium states and the temperature is usually uniform throughout the system. The only exception is if the system happens to have internal adiabatic partitions that allow phases of different temperatures in an equilibrium state. As mentioned in the footnote on page 106, when the process is reversible and the temperature is uniform, we can replace $dS = \delta q_{\text{rev}}/T_b$ by $dS = \delta q_{\text{rev}}/T$.

The rest of Sec. 4.6 will apply Eqs. 4.6.1 and 4.6.2 to various reversible and irreversible processes.

4.6.1 Reversible heating

The definition of the heat capacity C of a closed system is given by Eq. 3.1.9 on page 63: $C \stackrel{\text{def}}{=} \delta q/dT$. For reversible heating or cooling of a homogeneous phase, δq is equal to $T dS$ and we can write

$$\Delta S = \int_{T_1}^{T_2} \frac{C}{T} dT \quad (4.6.3)$$

where C should be replaced by C_V if the volume is constant, or by C_p if the pressure is constant (Sec. 3.1.5). If the heat capacity has a constant value over the temperature range from T_1 to T_2 , the equation becomes

$$\Delta S = C \ln \frac{T_2}{T_1} \quad (4.6.4)$$

Heating increases the entropy, and cooling decreases it.

4.6.2 Reversible expansion of an ideal gas

When the volume of an ideal gas, or of any other fluid, is changed reversibly and *adiabatically*, there is of course no entropy change.

When the volume of an ideal gas is changed reversibly and *isothermally*, there is expansion work given by $w = -nRT \ln(V_2/V_1)$ (Eq. 3.5.1). Since the internal energy of an ideal gas is constant at constant temperature, there must be heat of equal magnitude and opposite sign: $q = nRT \ln(V_2/V_1)$. The entropy change is therefore

$$\Delta S = nR \ln \frac{V_2}{V_1} \quad (4.6.5)$$

(reversible isothermal volume
change of an ideal gas)

Isothermal expansion increases the entropy, and isothermal compression decreases it.

Since the change of a state function depends only on the initial and final states, Eq. 4.6.5 gives a valid expression for ΔS of an ideal gas under the less stringent condition $T_2 = T_1$; it is not necessary for the intermediate states to be equilibrium states of the same temperature.

4.6.3 Spontaneous changes in an isolated system

An isolated system is one that exchanges no matter or energy with its surroundings. Any change of state of an isolated system that actually occurs is spontaneous, and arises solely from conditions within the system, uninfluenced by changes in the surroundings—the process occurs by itself, of its own accord. The initial state and the intermediate states of the process must be nonequilibrium states, because by definition an equilibrium state would not change over time in the isolated system.

Unless the spontaneous change is purely mechanical, it is irreversible. According to the second law, during an infinitesimal change that is irreversible and adiabatic, the entropy increases. For the isolated system, we can therefore write

$$dS > 0 \quad (4.6.6)$$

(irreversible change, isolated system)

In later chapters, the inequality of Eq. 4.6.6 will turn out to be one of the most useful for deriving conditions for spontaneity and equilibrium in chemical systems: *The entropy of an isolated system continuously increases during a spontaneous, irreversible process until it reaches a maximum value at equilibrium.*

If we treat the universe as an isolated system (although cosmology provides no assurance that this is a valid concept), we can say that as spontaneous changes occur in the universe, its entropy continuously increases. Clausius summarized the first and second laws in a famous statement: *Die Energie der Welt ist constant; die Entropie der Welt strebt einem Maximum zu* (the energy of the universe is constant; the entropy of the universe strives toward a maximum).

4.6.4 Internal heat flow in an isolated system

Suppose the system is a solid body whose temperature initially is nonuniform. Provided there are no internal adiabatic partitions, the initial state is a nonequilibrium state lacking internal thermal equilibrium. If the system is surrounded by thermal insulation, and volume changes are negligible, this is an isolated system. There will be a spontaneous, irreversible internal redistribution of thermal energy that eventually brings the system to a final equilibrium state of uniform temperature.

In order to be able to specify internal temperatures at any instant, we treat the system as an assembly of phases, each having a uniform temperature that can vary with time. To describe a region that has a continuous temperature gradient, we approximate the region with a very large number of very small phases or parcels, each having a temperature infinitesimally different from its neighbors.

We use Greek letters to label the phases. The temperature of phase α at any given instant is T^α . We can treat each phase as a subsystem with a boundary across which there can be energy transfer in the form of heat. Let $\delta q_{\alpha\beta}$ represent an infinitesimal quantity of heat transferred during an infinitesimal interval of time to phase α from phase β . The heat transfer, if any, is to the cooler from the warmer phase. If phases α and β are in thermal contact and T^α is less than T^β , then $\delta q_{\alpha\beta}$ is positive; if the phases are in thermal contact and T^α is greater than T^β , $\delta q_{\alpha\beta}$ is negative; and if neither of these conditions is satisfied, $\delta q_{\alpha\beta}$ is zero.

To evaluate the entropy change, we need a reversible path from the initial to the final state. The net quantity of heat transferred to phase α during an infinitesimal time interval is $\delta q^\alpha = \sum_{\beta \neq \alpha} \delta q_{\alpha\beta}$. The entropy change of phase α is the same as it would be for the reversible transfer of this heat from a heat reservoir of temperature T^α : $dS^\alpha = \delta q^\alpha / T^\alpha$. The entropy change of the entire system along the reversible path is found by summing over all phases:

$$\begin{aligned} dS &= \sum_{\alpha} dS^\alpha = \sum_{\alpha} \frac{\delta q^\alpha}{T^\alpha} = \sum_{\alpha} \sum_{\beta \neq \alpha} \frac{\delta q_{\alpha\beta}}{T^\alpha} \\ &= \sum_{\alpha} \sum_{\beta > \alpha} \left(\frac{\delta q_{\alpha\beta}}{T^\alpha} + \frac{\delta q_{\beta\alpha}}{T^\beta} \right) \end{aligned} \quad (4.6.7)$$

There is also the condition of quantitative energy transfer, $\delta q_{\beta\alpha} = -\delta q_{\alpha\beta}$, which we use to rewrite Eq. 4.6.7 in the form

$$dS = \sum_{\alpha} \sum_{\beta > \alpha} \left(\frac{1}{T^\alpha} - \frac{1}{T^\beta} \right) \delta q_{\alpha\beta} \quad (4.6.8)$$

Consider an individual term of the sum on the right side of Eq. 4.6.8 that has a nonzero value of $\delta q_{\alpha\beta}$ due to finite heat transfer between phases α and β . If T^α is less than T^β , then both $\delta q_{\alpha\beta}$ and $(1/T^\alpha - 1/T^\beta)$ are positive. If, on the other hand, T^α is greater than T^β , both $\delta q_{\alpha\beta}$ and $(1/T^\alpha - 1/T^\beta)$ are negative. Thus each term of the sum is either zero or positive, and as long as phases of different temperature are present, dS is positive.

This derivation shows that during a spontaneous thermal equilibration process in an isolated system, starting with any initial distribution of the internal temperatures, the entropy continuously increases until the system reaches a state of thermal equilibrium with a single uniform temperature throughout.¹⁰ The result agrees with Eq. 4.6.6.

4.6.5 Free expansion of a gas

Consider the free expansion of a gas shown in Fig. 3.9 on page 82. The *system* is the gas. Assume that the vessel walls are rigid and adiabatic, so that the system is isolated. When the

¹⁰Leff, in Ref. [105], obtains the same result by a more complicated derivation.

stopcock between the two vessels is opened, the gas expands irreversibly into the vacuum without heat or work and at constant internal energy. To carry out the same change of state reversibly, we confine the gas at its initial volume and temperature in a cylinder-and-piston device and use the piston to expand the gas adiabatically with negative work. Positive heat is then needed to return the internal energy reversibly to its initial value. Because the reversible path has positive heat, the entropy change is positive.

This is an example of an irreversible process in an isolated system for which a reversible path between the initial and final states has both heat and work.

4.6.6 Adiabatic process with work

In general (page 98), an adiabatic process with a given initial equilibrium state and a given change of a work coordinate has the least positive or most negative work in the reversible limit. Consider an irreversible adiabatic process with work w_{irr} . The same change of state can be accomplished reversibly by the following two steps: (1) a reversible adiabatic change of the work coordinate with work w_{rev} , followed by (2) reversible transfer of heat q_{rev} with no further change of the work coordinate. Since w_{rev} is algebraically less than w_{irr} , q_{rev} must be positive in order to make ΔU the same in the irreversible and reversible paths. The positive heat increases the entropy along the reversible path, and consequently the irreversible adiabatic process has a positive entropy change. This conclusion agrees with the second-law inequality of Eq. 4.6.1.

4.7 Summary

Some of the important terms and definitions discussed in this chapter are as follows.

- Any conceivable process is either spontaneous, reversible, or impossible.
- A *reversible* process proceeds by a continuous sequence of equilibrium states.
- A *spontaneous* process is one that proceeds naturally at a finite rate.
- An *irreversible* process is a spontaneous process whose reverse is impossible.
- A *purely mechanical process* is an idealized process without temperature gradients, and without friction or other dissipative effects, that is spontaneous in either direction. This kind of process will be ignored in the remaining chapters of this book.
- Except for a purely mechanical process, the terms *spontaneous* and *irreversible* are equivalent.

The derivation of the mathematical statement of the second law shows that during a reversible process of a closed system, the infinitesimal quantity $\delta q/T_b$ equals the infinitesimal change of a state function called the entropy, S . Here δq is heat transferred at the boundary where the temperature is T_b .

In each infinitesimal path element of a process of a closed system, dS is equal to $\delta q/T_b$ if the process is reversible, and is greater than $\delta q/T_b$ if the process is irreversible, as summarized by the relation $dS \geq \delta q/T_b$.

Consider two particular equilibrium states 1 and 2 of a closed system. The system can change from state 1 to state 2 by either a reversible process, with ΔS equal to the integral $\int(\delta q/T_b)$, or an irreversible process, with ΔS greater than $\int(\delta q/T_b)$. It is important to keep in mind the point made by Fig. 4.12 on the next page: because S is a state function, it

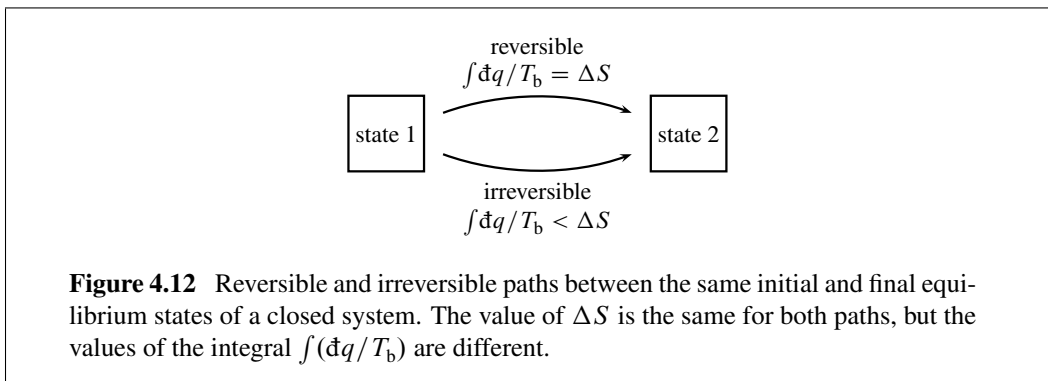

is the value of the integral that is different in the two cases, and not the value of ΔS .

The second law establishes no general relation between entropy changes and heat in an open system, or for an impossible process. The entropy of an open system may increase or decrease depending on whether matter enters or leaves. It is possible to imagine different impossible processes in which dS is less than, equal to, and greater than $\dot{d}q/T_b$.

4.8 The Statistical Interpretation of Entropy

Because entropy is such an important state function, it is natural to seek a description of its meaning on the microscopic level.

Entropy is sometimes said to be a measure of “disorder.” According to this idea, the entropy increases whenever a closed system becomes more disordered on a microscopic scale. This description of entropy as a measure of disorder is highly misleading. It does not explain why entropy is increased by reversible heating at constant volume or pressure, or why it increases during the reversible isothermal expansion of an ideal gas. Nor does it seem to agree with the freezing of a supercooled liquid or the formation of crystalline solute in a supersaturated solution; these processes can take place spontaneously in an isolated system, yet are accompanied by an apparent *decrease* of disorder.

Thus we should not interpret entropy as a measure of disorder. We must look elsewhere for a satisfactory microscopic interpretation of entropy.

A rigorous interpretation is provided by the discipline of *statistical mechanics*, which derives a precise expression for entropy based on the behavior of macroscopic amounts of microscopic particles. Suppose we focus our attention on a particular macroscopic equilibrium state. Over a period of time, while the system is in this equilibrium state, the system at each instant is in a *microstate*, or stationary quantum state, with a definite energy. The microstate is one that is *accessible* to the system—that is, one whose wave function is compatible with the system’s volume and with any other conditions and constraints imposed on the system. The system, while in the equilibrium state, continually jumps from one accessible microstate to another, and the macroscopic state functions described by classical thermodynamics are time averages of these microstates.

The fundamental assumption of statistical mechanics is that accessible microstates of equal energy are equally probable, so that the system while in an equilibrium state spends an equal fraction of its time in each such microstate. The statistical entropy of the equilibrium

state then turns out to be given by the equation

$$S_{\text{stat}} = k \ln W + C \quad (4.8.1)$$

where k is the Boltzmann constant $k = R/N_A$, W is the number of accessible microstates, and C is a constant.

In the case of an equilibrium state of a perfectly-isolated system of constant internal energy U , the accessible microstates are the ones that are compatible with the constraints and whose energies all have the same value, equal to the value of U .

It is more realistic to treat an equilibrium state with the assumption the system is in thermal equilibrium with an external constant-temperature heat reservoir. The internal energy then fluctuates over time with extremely small deviations from the average value U , and the accessible microstates are the ones with energies close to this average value. In the language of statistical mechanics, the results for an isolated system are derived with a microcanonical ensemble, and for a system of constant temperature with a canonical ensemble.

A change ΔS_{stat} of the statistical entropy function given by Eq. 4.8.1 is the same as the change ΔS of the macroscopic second-law entropy, because the derivation of Eq. 4.8.1 is based on the macroscopic relation $dS_{\text{stat}} = \delta q/T = (dU - \delta w)/T$ with dU and δw given by statistical theory. If the integration constant C is set equal to zero, S_{stat} becomes the third-law entropy S to be described in Chap. 6.

Equation 4.8.1 shows that a reversible process in which entropy increases is accompanied by an increase in the number of accessible microstates of equal, or nearly equal, internal energies. This interpretation of entropy increase has been described as the spreading and sharing of energy¹¹ and as the dispersal of energy.¹² It has even been proposed that entropy should be thought of as a “spreading function” with its symbol S suggesting *spreading*.^{13,14}

¹¹Ref. [106]. ¹²Ref. [103]. ¹³Ref. [104]. ¹⁴The symbol S for entropy seems originally to have been an arbitrary choice by Clausius; see Ref. [89].

PROBLEMS

An underlined problem number or problem-part letter indicates that the numerical answer appears in Appendix I.

- 4.1** Explain why an electric refrigerator, which transfers energy by means of heat from the cold food storage compartment to the warmer air in the room, is not an impossible “Clausius device.”
- 4.2** A system consisting of a fixed amount of an ideal gas is maintained in thermal equilibrium with a heat reservoir at temperature T . The system is subjected to the following isothermal cycle:
1. The gas, initially in an equilibrium state with volume V_0 , is allowed to expand into a vacuum and reach a new equilibrium state of volume V' .
 2. The gas is reversibly compressed from V' to V_0 .

For this cycle, find expressions or values for w , $\oint \dot{q}/T$, and $\oint dS$.

- 4.3** In an irreversible isothermal process of a closed system:
- (a) Is it possible for ΔS to be negative?
 - (b) Is it possible for ΔS to be less than q/T ?
- 4.4** Suppose you have two blocks of copper, each of heat capacity $C_V = 200.0 \text{ J K}^{-1}$. Initially one block has a uniform temperature of 300.00 K and the other 310.00 K. Calculate the entropy change that occurs when you place the two blocks in thermal contact with one another and surround them with perfect thermal insulation. Is the sign of ΔS consistent with the second law? (Assume the process occurs at constant volume.)
- 4.5** Refer to the apparatus shown in Figs. 3.23 on page 101 and 3.26 on page 103 and described in Probs. 3.3 and 3.8. For both systems, evaluate ΔS for the process that results from opening the stopcock. Also evaluate $\int \dot{q}/T_{\text{ext}}$ for both processes (for the apparatus in Fig. 3.26, assume the vessels have adiabatic walls). Are your results consistent with the mathematical statement of the second law?

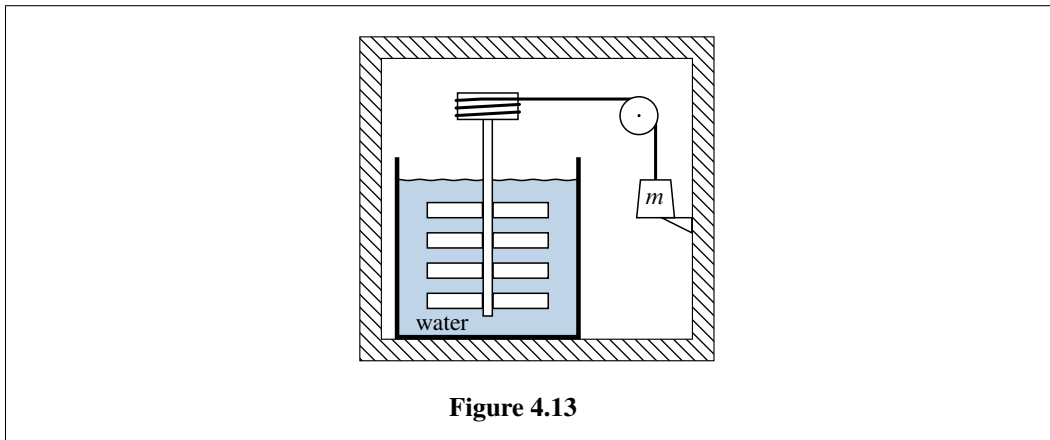

Figure 4.13

- 4.6** Figure 4.13 shows the walls of a rigid thermally-insulated box (cross hatching). The system is the contents of this box. In the box is a paddle wheel immersed in a container of water, connected by a cord and pulley to a weight of mass m . The weight rests on a stop located a distance h above the bottom of the box. Assume the heat capacity of the system, C_V , is independent of temperature. Initially the system is in an equilibrium state at temperature T_1 .

When the stop is removed, the weight irreversibly sinks to the bottom of the box, causing the paddle wheel to rotate in the water. Eventually the system reaches a final equilibrium state with thermal equilibrium. Describe a *reversible* process with the same entropy change as this irreversible process, and derive a formula for ΔS in terms of m , h , C_V , and T_1 .

THERMODYNAMIC POTENTIALS

This chapter begins with a discussion of mathematical properties of the total differential of a dependent variable. Three extensive state functions with dimensions of energy are introduced: enthalpy, Helmholtz energy, and Gibbs energy. These functions, together with internal energy, are called **thermodynamic potentials**.¹ Some formal mathematical manipulations of the four thermodynamic potentials are described that lead to expressions for heat capacities, surface work, and criteria for spontaneity in closed systems.

5.1 Total Differential of a Dependent Variable

Recall from Sec. 2.4.1 that the state of the system at each instant is defined by a certain minimum number of state functions, the independent variables. State functions not treated as independent variables are dependent variables. Infinitesimal changes in any of the independent variables will, in general, cause an infinitesimal change in each dependent variable.

A dependent variable is a function of the independent variables. The **total differential** of a dependent variable is an expression for the infinitesimal change of the variable in terms of the infinitesimal changes of the independent variables. As explained in Sec. F.2 of Appendix F, the expression can be written as a sum of terms, one for each independent variable. Each term is the product of a partial derivative with respect to one of the independent variables and the infinitesimal change of that independent variable. For example, if the system has two independent variables, and we take these to be T and V , the expression for the total differential of the pressure is

$$dp = \left(\frac{\partial p}{\partial T} \right)_V dT + \left(\frac{\partial p}{\partial V} \right)_T dV \quad (5.1.1)$$

Thus, in the case of a fixed amount of an ideal gas with pressure given by $p = nRT/V$, the total differential of the pressure can be written

$$dp = \frac{nR}{V} dT - \frac{nRT}{V^2} dV \quad (5.1.2)$$

¹The term *thermodynamic potential* should not be confused with the *chemical potential*, μ , to be introduced on page 140.

5.2 Total Differential of the Internal Energy

For a closed system undergoing processes in which the only kind of work is expansion work, the first law becomes $dU = \delta q + \delta w = \delta q - p_b dV$. Since it will often be useful to make a distinction between expansion work and other kinds of work, this book will sometimes write the first law in the form

$$dU = \delta q - p_b dV + \delta w' \quad (5.2.1)$$

(closed system)

where $\delta w'$ is **nonexpansion work**—that is, any thermodynamic work that is not expansion work.

Consider a closed system of one chemical component (e.g., a pure substance) in a single homogeneous phase. The only kind of work is expansion work, with V as the work variable. This kind of system has *two* independent variables (Sec. 2.4.3). During a *reversible* process in this system, the heat is $\delta q = T dS$, the work is $\delta w = -p dV$, and an infinitesimal internal energy change is given by

$$dU = T dS - p dV \quad (5.2.2)$$

(closed system, $C=1$,
 $P=1$, $\delta w'=0$)

In the conditions of validity shown next to this equation, $C=1$ means there is one component (C is the number of components) and $P=1$ means there is one phase (P is the number of phases).

The appearance of the intensive variables T and p in Eq. 5.2.2 implies, of course, that the temperature and pressure are uniform throughout the system during the process. If they were not uniform, the phase would not be homogeneous and there would be more than two independent variables. The temperature and pressure are strictly uniform only if the process is reversible; it is not necessary to include “reversible” as one of the conditions of validity.

A real process approaches a reversible process in the limit of infinite slowness. For all practical purposes, therefore, we may apply Eq. 5.2.2 to a process obeying the conditions of validity and taking place so slowly that the temperature and pressure remain essentially uniform—that is, for a process in which the system stays very close to thermal and mechanical equilibrium.

Because the system under consideration has two independent variables, Eq. 5.2.2 is an expression for the total differential of U with S and V as the independent variables. In general, an expression for the differential dX of a state function X is a total differential if

1. it is a valid expression for dX , consistent with the physical nature of the system and any conditions and constraints;
2. it is a sum with the same number of terms as the number of independent variables;
3. each term of the sum is a function of state functions multiplied by the differential of one of the independent variables.

Note that the work coordinate of any kind of dissipative work—work without a reversible limit—cannot appear in the expression for a total differential, because it is not a state function (Sec. 3.10).

As explained in Appendix F, we may identify the coefficient of each term in an expression for the total differential of a state function as a partial derivative of the function. We identify the coefficients on the right side of Eq. 5.2.2 as follows:

$$T = \left(\frac{\partial U}{\partial S} \right)_V \quad -p = \left(\frac{\partial U}{\partial V} \right)_S \quad (5.2.3)$$

Now let us consider some of the ways a system might have more than two independent variables. Suppose the system has one phase and one substance, with expansion work only, and is *open* so that the amount n of the substance can vary. Such a system has three independent variables. Let us write the formal expression for the total differential of U with S , V , and n as the three independent variables:

$$dU = \left(\frac{\partial U}{\partial S} \right)_{V,n} dS + \left(\frac{\partial U}{\partial V} \right)_{S,n} dV + \left(\frac{\partial U}{\partial n} \right)_{S,V} dn \quad (5.2.4)$$

(pure substance,
 $P=1, \dot{w}'=0$)

We have seen above that if the system is *closed*, the partial derivatives are $(\partial U/\partial S)_V = T$ and $(\partial U/\partial V)_S = -p$. Since both of these partial derivatives are for a closed system in which n is constant, they are the same as the first two partial derivatives on the right side of Eq. 5.2.4.

The quantity given by the third partial derivative, $(\partial U/\partial n)_{S,V}$, is represented by the symbol μ (mu). This quantity is an intensive state function called the **chemical potential**.

With these substitutions, Eq. 5.2.4 becomes

$$dU = T dS - p dV + \mu dn \quad (5.2.5)$$

(pure substance,
 $P=1, \dot{w}'=0$)

and this is a valid expression for the total differential of U under the given conditions.

If a system contains a mixture of s different substances in a single phase, and the system is open so that the amount of each substance can vary independently, there are $2 + s$ independent variables and the total differential of U can be written

$$dU = T dS - p dV + \sum_{i=1}^s \mu_i dn_i \quad (5.2.6)$$

(open system,
 $P=1, \dot{w}'=0$)

The coefficient μ_i is the chemical potential of substance i . We identify it as the partial derivative $(\partial U/\partial n_i)_{S,V,n_j \neq i}$.

The term $-p dV$ on the right side of Eq. 5.2.6 is the reversible work. However, the term $T dS$ does not equal the reversible heat as it would if the system were closed. This is because the entropy change dS is partly due to the entropy of the matter transferred across the boundary. It follows that the remaining term, $\sum_i \mu_i dn_i$ (sometimes called the “chemical work”), should not be interpreted as the energy brought into the system by the transfer of matter.²

²Ref. [100].

Suppose that in addition to expansion work, other kinds of reversible work are possible. Each work coordinate adds an additional independent variable. Thus, for a closed system of one component in one phase, with reversible nonexpansion work given by $\delta w' = Y dX$, the total differential of U becomes

$$dU = T dS - p dV + Y dX \quad (5.2.7)$$

(closed system,
 $C=1, P=1$)

5.3 Enthalpy, Helmholtz Energy, and Gibbs Energy

For the moment we shall confine our attention to closed systems with one component in one phase. The total differential of the internal energy in such a system is given by Eq. 5.2.2: $dU = T dS - p dV$. The independent variables in this equation, S and V , are called the *natural variables* of U .

In the laboratory, entropy and volume may not be the most convenient variables to measure and control. Entropy is especially inconvenient, as its value cannot be measured directly. The way to change the independent variables is to make Legendre transforms, as explained in Sec. F.4 in Appendix F.

A Legendre transform of a dependent variable is made by subtracting one or more products of *conjugate variables*. In the total differential $dU = T dS - p dV$, T and S are conjugates (that is, they comprise a *conjugate pair*), and $-p$ and V are conjugates. Thus the products that can be subtracted from U are either TS or $-pV$, or both. Three Legendre transforms of the internal energy are possible, defined as follows:

$$\mathbf{Enthalpy} \quad H \stackrel{\text{def}}{=} U + pV \quad (5.3.1)$$

$$\mathbf{Helmholtz energy} \quad A \stackrel{\text{def}}{=} U - TS \quad (5.3.2)$$

$$\mathbf{Gibbs energy} \quad G \stackrel{\text{def}}{=} U - TS + pV = H - TS \quad (5.3.3)$$

These definitions are used whether or not the system has only two independent variables.

The enthalpy, Helmholtz energy, and Gibbs energy are important functions used extensively in thermodynamics. They are state functions (because the quantities used to define them are state functions) and are extensive (because U , S , and V are extensive). If temperature or pressure are not uniform in the system, we can apply the definitions to constituent phases, or to subsystems small enough to be essentially uniform, and sum over the phases or subsystems.

Alternative names for the Helmholtz energy are Helmholtz function, Helmholtz free energy, and work function. Alternative names for the Gibbs energy are Gibbs function and Gibbs free energy. Both the Helmholtz energy and Gibbs energy have been called simply free energy, and the symbol F has been used for both. The nomenclature in this book follows the recommendations of the IUPAC Green Book (Ref. [36]).

Expressions for infinitesimal changes of H , A , and G are obtained by applying the rules of differentiation to their defining equations:

$$dH = dU + p dV + V dp \quad (5.3.4)$$

BIOGRAPHICAL SKETCH
Josiah Willard Gibbs (1839–1903)

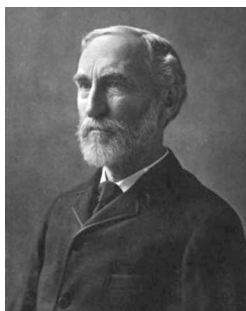

Willard Gibbs's brilliant and rigorous formulation of the theoretical basis of classical thermodynamics was essential for further development of the subject.

Gibbs was born in New Haven, Connecticut, and lived there all his life. His father was a professor in the Yale Divinity School. Gibbs was Professor of Mathematical Physics at Yale College from 1871 until his death.

Gibbs never married. In demeanor he was serene, kindly, reserved, and self-effacing. A biographer wrote:^a

Gibbs' attitude toward his discoveries is also illuminating as to his character. . . he made no effort to "sell" his discoveries (aside from the usual distribution of reprints of his papers) or to popularize the results. He was so confident of their rightness and ability to stand on their own feet that he was entirely content to let their value and importance be "discovered" by others. The fact that *he* had made a discovery was to him an irrelevant matter; the important thing was the truth established.

In 1873, when he was 34, the first two of Gibbs's remarkable papers on theoretical thermodynamics appeared in an obscure journal, *Transactions of the Connecticut Academy*.^{b,c} These papers explored relations among state functions using two- and three-dimensional geometrical constructions.

James Clerk Maxwell promoted Gibbs's ideas in England, and made a small plaster model of the three-dimensional S - V - U sur-

face for H_2O which he sent to Gibbs.

The two papers of 1873 were followed by a monumental paper in the same journal—in two parts (1876 and 1878) and over 300 pages in length!—entitled simply "On the Equilibrium of Heterogeneous Substances."^d This third paper used an analytical rather than geometrical approach. From the first and second laws of thermodynamics, it derived the conditions needed for equilibrium in the general case of a multiphase, multicomponent system. It introduced the state functions now known as enthalpy, Helmholtz energy,^e Gibbs energy, and chemical potential. Included in the paper was the exposition of the Gibbs phase rule.

The only public comment Gibbs ever made on his thermodynamic papers was in a letter of 1881 accepting membership in the American Academy of Arts and Sciences.^f

The leading idea which I followed in my paper on the Equilibrium of Heterogeneous Substances was to develop the *rôles* of energy and entropy in the theory of thermo-dynamic equilibrium. By means of these quantities the general condition of equilibrium is easily expressed, and by applying this to various cases we are led at once to the special conditions which characterize them. We thus obtain the consequences resulting from the fundamental principles of thermo-dynamics (which are implied in the definitions of energy and entropy) by a process which seems more simple, and which lends itself more readily to the solution of problems, than the usual method, in which the several parts of a cyclic operation are explicitly and separately considered. Although my results were in a large measure such as had previously been demonstrated by other methods, yet, as I readily obtained those which were to me before unknown, I was confirmed in my belief in the suitability of the method adopted.

Gibbs had a visit about 1898 from a young Gilbert Lewis. He told Lewis that he was rather lonely at Yale, where few others were actively interested in his work.^g

^aRef. [183], page 83. ^bRef. [67]. ^cRef. [68]. ^dRef. [69]. ^eHermann von Helmholtz, a German physiologist and physicist, introduced the term "free energy" for this quantity in 1882. ^fRef. [183], page 89. ^gRef. [141].

$$dA = dU - T dS - S dT \quad (5.3.5)$$

$$dG = dU - T dS - S dT + p dV + V dp \quad (5.3.6)$$

These expressions for dH , dA , and dG are general expressions for any system or phase with uniform T and p . They are *not* total differentials of H , A , and G , as the variables in the differentials in each expression are not independent.

A useful property of the enthalpy in a closed system can be found by replacing dU in Eq. 5.3.4 by the first law expression $\dot{d}q - p dV + \dot{d}w'$, to obtain $dH = \dot{d}q + V dp + \dot{d}w'$. Thus, in a process at constant pressure ($dp = 0$) with expansion work only ($\dot{d}w' = 0$), we have

$$dH = \dot{d}q \quad (5.3.7)$$

(closed system, constant p ,
 $\dot{d}w' = 0$)

The enthalpy change under these conditions is equal to the heat. The integrated form of this relation is $\int dH = \int \dot{d}q$, or

$$\Delta H = q \quad (5.3.8)$$

(closed system, constant p ,
 $w' = 0$)

Equation 5.3.7 is analogous to the following relation involving the internal energy, obtained from the first law:

$$dU = \dot{d}q \quad (5.3.9)$$

(closed system, constant V ,
 $\dot{d}w' = 0$)

That is, in a process at constant volume with expansion work only, the internal energy change is equal to the heat.

5.4 Closed Systems

In order to find expressions for the total differentials of H , A , and G in a closed system with one component in one phase, we must replace dU in Eqs. 5.3.4–5.3.6 with

$$dU = T dS - p dV \quad (5.4.1)$$

to obtain

$$dH = T dS + V dp \quad (5.4.2)$$

$$dA = -S dT - p dV \quad (5.4.3)$$

$$dG = -S dT + V dp \quad (5.4.4)$$

Equations 5.4.1–5.4.4 are sometimes called the **Gibbs equations**. They are expressions for the total differentials of the thermodynamic potentials U , H , A , and G in closed systems of one component in one phase with expansion work only. Each equation shows how

the dependent variable on the left side varies as a function of changes in two independent variables (the natural variables of the dependent variable) on the right side.

By identifying the coefficients on the right side of Eqs. 5.4.1–5.4.4, we obtain the following relations (which again are valid for a closed system of one component in one phase with expansion work only):

$$\text{from Eq. 5.4.1: } \left(\frac{\partial U}{\partial S} \right)_V = T \quad (5.4.5)$$

$$\left(\frac{\partial U}{\partial V} \right)_S = -p \quad (5.4.6)$$

$$\text{from Eq. 5.4.2: } \left(\frac{\partial H}{\partial S} \right)_p = T \quad (5.4.7)$$

$$\left(\frac{\partial H}{\partial p} \right)_S = V \quad (5.4.8)$$

$$\text{from Eq. 5.4.3: } \left(\frac{\partial A}{\partial T} \right)_V = -S \quad (5.4.9)$$

$$\left(\frac{\partial A}{\partial V} \right)_T = -p \quad (5.4.10)$$

$$\text{from Eq. 5.4.4: } \left(\frac{\partial G}{\partial T} \right)_p = -S \quad (5.4.11)$$

$$\left(\frac{\partial G}{\partial p} \right)_T = V \quad (5.4.12)$$

This book now uses for the first time an extremely useful mathematical tool called the **reciprocity relation** of a total differential (Sec. F.2). Suppose the independent variables are x and y and the total differential of a dependent state function f is given by

$$df = a dx + b dy \quad (5.4.13)$$

where a and b are functions of x and y . Then the reciprocity relation is

$$\left(\frac{\partial a}{\partial y} \right)_x = \left(\frac{\partial b}{\partial x} \right)_y \quad (5.4.14)$$

The reciprocity relations obtained from the Gibbs equations (Eqs. 5.4.1–5.4.4) are called **Maxwell relations** (again valid for a closed system with $C=1$, $P=1$, and $\delta w'=0$):

$$\text{from Eq. 5.4.1: } \left(\frac{\partial T}{\partial V} \right)_S = - \left(\frac{\partial p}{\partial S} \right)_V \quad (5.4.15)$$

$$\text{from Eq. 5.4.2: } \left(\frac{\partial T}{\partial p} \right)_S = \left(\frac{\partial V}{\partial S} \right)_p \quad (5.4.16)$$

$$\text{from Eq. 5.4.3: } \left(\frac{\partial S}{\partial V} \right)_T = \left(\frac{\partial p}{\partial T} \right)_V \quad (5.4.17)$$

$$\text{from Eq. 5.4.4: } - \left(\frac{\partial S}{\partial p} \right)_T = \left(\frac{\partial V}{\partial T} \right)_p \quad (5.4.18)$$

5.5 Open Systems

An open system of one substance in one phase, with expansion work only, has three independent variables. The total differential of U is given by Eq. 5.2.5:

$$dU = T dS - p dV + \mu dn \quad (5.5.1)$$

In this open system the natural variables of U are S , V , and n . Substituting this expression for dU into the expressions for dH , dA , and dG given by Eqs. 5.3.4–5.3.6, we obtain the following total differentials:

$$dH = T dS + V dp + \mu dn \quad (5.5.2)$$

$$dA = -S dT - p dV + \mu dn \quad (5.5.3)$$

$$dG = -S dT + V dp + \mu dn \quad (5.5.4)$$

Note that these are the same as the four Gibbs equations (Eqs. 5.4.1–5.4.4) with the addition of a term μdn to allow for a change in the amount of substance.

Identification of the coefficient of the last term on the right side of each of these equations shows that the chemical potential can be equated to four different partial derivatives:

$$\mu = \left(\frac{\partial U}{\partial n} \right)_{S,V} = \left(\frac{\partial H}{\partial n} \right)_{S,p} = \left(\frac{\partial A}{\partial n} \right)_{T,V} = \left(\frac{\partial G}{\partial n} \right)_{T,p} \quad (5.5.5)$$

All four of these partial derivatives must have the same value for a given state of the system; the value, of course, depends on what that state is.

The last partial derivative on the right side of Eq. 5.5.5, $(\partial G/\partial n)_{T,p}$, is especially interesting because it is the rate at which the Gibbs energy increases with the amount of substance added to a system whose intensive properties remain constant. Thus, μ is revealed to be equal to G_m , the molar Gibbs energy of the substance.

Suppose the system contains several substances or species in a single phase (a mixture) whose amounts can be varied independently. We again assume the only work is expansion work. Then, making use of Eq. 5.2.6, we find the total differentials of the thermodynamic potentials are given by

$$dU = T dS - p dV + \sum_i \mu_i dn_i \quad (5.5.6)$$

$$dH = T dS + V dp + \sum_i \mu_i dn_i \quad (5.5.7)$$

$$dA = -S dT - p dV + \sum_i \mu_i dn_i \quad (5.5.8)$$

$$dG = -S dT + V dp + \sum_i \mu_i dn_i \quad (5.5.9)$$

The independent variables on the right side of each of these equations are the natural variables of the corresponding thermodynamic potential. Section F.4 shows that all of the information contained in an algebraic expression for a state function is preserved in a Legendre transform of the function. What this means for the thermodynamic potentials is that an

expression for any one of them, as a function of its natural variables, can be converted to an expression for each of the other thermodynamic potentials as a function of its natural variables.

Willard Gibbs, after whom the Gibbs energy is named, called Eqs. 5.5.6–5.5.9 the *fundamental equations* of thermodynamics, because from any single one of them not only the other thermodynamic potentials but also all thermal, mechanical, and chemical properties of the system can be deduced.³ Problem 5.4 illustrates this useful application of the total differential of a thermodynamic potential.

In Eqs. 5.5.6–5.5.9, the coefficient μ_i is the chemical potential of species i . The equations show that μ_i can be equated to four different partial derivatives, similar to the equalities shown in Eq. 5.5.5 for a pure substance:

$$\mu_i = \left(\frac{\partial U}{\partial n_i} \right)_{S,V,n_j \neq i} = \left(\frac{\partial H}{\partial n_i} \right)_{S,p,n_j \neq i} = \left(\frac{\partial A}{\partial n_i} \right)_{T,V,n_j \neq i} = \left(\frac{\partial G}{\partial n_i} \right)_{T,p,n_j \neq i} \quad (5.5.10)$$

The partial derivative $(\partial G/\partial n_i)_{T,p,n_j \neq i}$ is called the *partial molar Gibbs energy* of species i , another name for the chemical potential as will be discussed in Sec. 9.2.6.

5.6 Expressions for Heat Capacity

As explained in Sec. 3.1.5, the heat capacity of a closed system is defined as the ratio of an infinitesimal quantity of heat transferred across the boundary under specified conditions and the resulting infinitesimal temperature change: heat capacity $\stackrel{\text{def}}{=} \delta q/dT$. The heat capacities of isochoric (constant volume) and isobaric (constant pressure) processes are of particular interest.

The **heat capacity at constant volume**, C_V , is the ratio $\delta q/dT$ for a process in a closed constant-volume system with no nonexpansion work—that is, no work at all. The first law shows that under these conditions the internal energy change equals the heat: $dU = \delta q$ (Eq. 5.3.9). We can replace δq by dU and write C_V as a partial derivative:

$$C_V = \left(\frac{\partial U}{\partial T} \right)_V \quad (5.6.1)$$

(closed system)

If the closed system has more than two independent variables, additional conditions are needed to define C_V unambiguously. For instance, if the system is a gas mixture in which reaction can occur, we might specify that the system remains in reaction equilibrium as T changes at constant V .

Equation 5.6.1 does not require the condition $\delta w' = 0$, because all quantities appearing in the equation are *state* functions whose relations to one another are fixed by the nature of the system and not by the path. Thus, if heat transfer into the system at constant V causes U to increase at a certain rate with respect to T , and this rate is defined as C_V , the performance of electrical work on the system at constant V will cause the same rate of increase of U with respect to T and can equally well be used to evaluate C_V .

Note that C_V is a state function whose value depends on the state of the system—that is, on T , V , and any additional independent variables. C_V is an *extensive* property: the

³Ref. [69], p. 86.

combination of two identical phases has twice the value of C_V that one of the phases has by itself.

For a phase containing a pure substance, the **molar heat capacity at constant volume** is defined by $C_{V,m} \stackrel{\text{def}}{=} C_V/n$. $C_{V,m}$ is an *intensive* property.

If the system is an ideal gas, its internal energy depends only on T , regardless of whether V is constant, and Eq. 5.6.1 can be simplified to

$$C_V = \frac{dU}{dT} \quad (5.6.2)$$

(closed system, ideal gas)

Thus the internal energy change of an ideal gas is given by $dU = C_V dT$, as mentioned earlier in Sec. 3.5.3.

The **heat capacity at constant pressure**, C_p , is the ratio $\delta q/dT$ for a process in a closed system with a constant, uniform pressure and with expansion work only. Under these conditions, the heat δq is equal to the enthalpy change dH (Eq. 5.3.7), and we obtain a relation analogous to Eq. 5.6.1:

$$C_p = \left(\frac{\partial H}{\partial T} \right)_p \quad (5.6.3)$$

(closed system)

C_p is an extensive state function. For a phase containing a pure substance, the **molar heat capacity at constant pressure** is $C_{p,m} = C_p/n$, an intensive property.

Since the enthalpy of a fixed amount of an ideal gas depends only on T (Prob. 5.1), we can write a relation analogous to Eq. 5.6.2:

$$C_p = \frac{dH}{dT} \quad (5.6.4)$$

(closed system, ideal gas)

5.7 Surface Work

Sometimes we need more than the usual two independent variables to describe an equilibrium state of a closed system of one substance in one phase. This is the case when, in addition to expansion work, another kind of work is possible. The total differential of U is then given by $dU = T dS - p dV + Y dX$ (Eq. 5.2.7), where $Y dX$ represents the nonexpansion work $\delta w'$.

A good example of this situation is surface work in a system in which surface area is relevant to the description of the state.

A liquid–gas interface behaves somewhat like a stretched membrane. The upper and lower surfaces of the liquid film in the device depicted in Fig. 5.1 on the next page exert a force F on the sliding rod, tending to pull it in the direction that reduces the surface area. We can measure the force by determining the opposing force F_{ext} needed to prevent the rod from moving. This force is found to be proportional to the length of the rod and independent of the rod position x . The force also depends on the temperature and pressure.

The **surface tension** or interfacial tension, γ , is the force exerted by an interfacial surface per unit length. The film shown in Fig. 5.1 has two surfaces, so we have $\gamma = F/2l$ where l is the rod length.

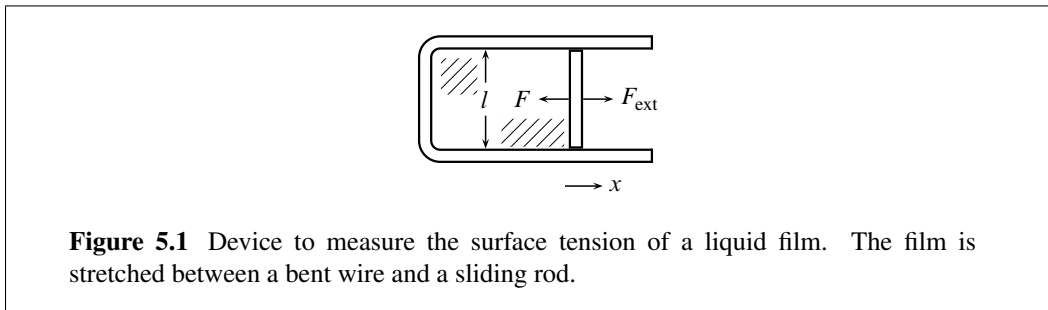

To increase the surface area of the film by a practically-reversible process, we slowly pull the rod to the right in the $+x$ direction. The *system* is the liquid. The x component of the force exerted by the system on the surroundings at the moving boundary, F_x^{sys} , is equal to $-F$ (F is positive and F_x^{sys} is negative). The displacement of the rod results in surface work given by Eq. 3.1.2: $\delta w' = -F_x^{\text{sys}} dx = 2\gamma l dx$. The increase in surface area, dA_s , is $2l dx$, so the surface work is $\delta w' = \gamma dA_s$ where γ is the work coefficient and A_s is the work coordinate. Equation 5.2.7 becomes

$$dU = T dS - p dV + \gamma dA_s \quad (5.7.1)$$

Substitution into Eq. 5.3.6 gives

$$dG = -S dT + V dp + \gamma dA_s \quad (5.7.2)$$

which is the total differential of G with T , p , and A_s as the independent variables. Identifying the coefficient of the last term on the right side as a partial derivative, we find the following expression for the surface tension:

$$\gamma = \left(\frac{\partial G}{\partial A_s} \right)_{T,p} \quad (5.7.3)$$

That is, the surface tension is not only a force per unit length, but also a Gibbs energy per unit area.

From Eq. 5.7.2, we obtain the reciprocity relation

$$\left(\frac{\partial \gamma}{\partial T} \right)_{p,A_s} = - \left(\frac{\partial S}{\partial A_s} \right)_{T,p} \quad (5.7.4)$$

It is valid to replace the partial derivative on the left side by $(\partial\gamma/\partial T)_p$ because γ is independent of A_s . Thus, the variation of surface tension with temperature tells us how the entropy of the liquid varies with surface area.

5.8 Criteria for Spontaneity

In this section we combine the first and second laws in order to derive some general relations for changes during a reversible or irreversible process of a closed system. The temperature and pressure will be assumed to be practically uniform during the process, even if the process is irreversible. For example, the volume might be changing at a finite rate but very

slowly, or there might be a spontaneous homogeneous reaction in a mixture of uniform temperature and pressure.

The second law states that dS is equal to $\delta q/T$ if the process is reversible, and is greater than $\delta q/T$ if the process is irreversible:

$$dS \geq \delta q/T \quad (5.8.1)$$

(irrev, closed system)

or

$$\delta q \leq T dS \quad (5.8.2)$$

(irrev, closed system)

The *inequalities* in these relations refer to an irreversible process and the *equalities* to a reversible process, as indicated by the notation $\frac{\text{irrev}}{\text{rev}}$.

When we substitute δq from Eq. 5.8.2 into the first law in the form $dU = \delta q - p dV + \delta w'$, where $\delta w'$ is nonexpansion work, we obtain the relation

$$dU \leq T dS - p dV + \delta w' \quad (5.8.3)$$

(irrev, closed system)

We substitute this relation for dU into the differentials of enthalpy, Helmholtz energy, and Gibbs energy given by Eqs. 5.3.4–5.3.6 to obtain three more relations:

$$dH \leq T dS + V dp + \delta w' \quad (5.8.4)$$

(irrev, closed system)

$$dA \leq -S dT - p dV + \delta w' \quad (5.8.5)$$

(irrev, closed system)

$$dG \leq -S dT + V dp + \delta w' \quad (5.8.6)$$

(irrev, closed system)

The last two of these relations provide valuable criteria for spontaneity under common laboratory conditions. Equation 5.8.5 shows that during a spontaneous irreversible change at constant temperature and volume, dA is less than $\delta w'$. If the only work is expansion work (i.e., $\delta w'$ is zero), the Helmholtz energy decreases during a spontaneous process at constant T and V and has its minimum value when the system reaches an equilibrium state.

Equation 5.8.6 is especially useful. From it, we can conclude the following:

- Reversible nonexpansion work at constant T and p is equal to the Gibbs energy change. For example, if the system is a galvanic cell operated in the reversible limit (Sec. 3.8.3) at constant T and p , the electrical work is given by $\delta w_{\text{el, rev}} = dG$. There is an application of this relation in Sec. 14.3.1.
- During a spontaneous process at constant T and p in a closed system with expansion work only, the Gibbs energy continuously decreases until the system reaches an equilibrium state.

Ben-Amotz and Honig⁴ developed a “rectification” procedure that simplifies the mathematical manipulation of inequalities. Following this procedure, we can write

$$dS = \delta q/T + \delta\theta \quad (5.8.7)$$

where $\delta\theta$ is an *excess entropy function* that is positive for an irreversible change and zero for a reversible change ($\delta\theta \geq 0$). Solving for δq gives the expression $\delta q = T dS - T \delta\theta$ that, when substituted in the first law expression $dU = \delta q - p dV + \delta w'$, produces

$$dU = T dS - p dV + \delta w' - T \delta\theta \quad (5.8.8)$$

The equality of this equation is equivalent to the combined equality and inequality of Eq. 5.8.3. Then by substitution of this expression for dU into Eqs. 5.3.4–5.3.6, we obtain equalities equivalent to Eqs. 5.8.4–5.8.6, for example

$$dG = -S dT + V dp + \delta w' - T \delta\theta \quad (5.8.9)$$

Equation 5.8.9 tells us that during a process at constant T and p , with expansion work only ($\delta w'=0$), dG has the same sign as $-T \delta\theta$: negative for an irreversible change and zero for a reversible change.

⁴Refs. [11] and [88].

PROBLEMS

An underlined problem number or problem-part letter indicates that the numerical answer appears in Appendix I.

- 5.1** Show that the enthalpy of a fixed amount of an ideal gas depends only on the temperature.
- 5.2** From concepts in this chapter, show that the heat capacities C_V and C_p of a fixed amount of an ideal gas are functions only of T .
- 5.3** During the reversible expansion of a fixed amount of an ideal gas, each increment of heat is given by the expression $\delta q = C_V dT + (nRT/V) dV$ (Eq. 4.3.4).
- (a) A necessary and sufficient condition for this expression to be an exact differential is that the reciprocity relation must be satisfied for the independent variables T and V (see Appendix F). Apply this test to show that the expression is *not* an exact differential, and that heat therefore is not a state function.
- (b) By the same method, show that the entropy increment during the reversible expansion, given by the expression $dS = \delta q/T$, is an exact differential, so that entropy is a state function.
- 5.4** This problem illustrates how an expression for one of the thermodynamic potentials as a function of its natural variables contains the information needed to obtain expressions for the other thermodynamic potentials and many other state functions.

From statistical mechanical theory, a simple model for a hypothetical “hard-sphere” liquid (spherical molecules of finite size without attractive intermolecular forces) gives the following expression for the Helmholtz energy with its natural variables T , V , and n as the independent variables:

$$A = -nRT \ln \left[cT^{3/2} \left(\frac{V}{n} - b \right) \right] - nRT + na$$

Here a , b , and c are constants. Derive expressions for the following state functions of this hypothetical liquid as functions of T , V , and n .

- (a) The entropy, S
- (b) The pressure, p
- (c) The chemical potential, μ
- (d) The internal energy, U
- (e) The enthalpy, H
- (f) The Gibbs energy, G
- (g) The heat capacity at constant volume, C_V
- (h) The heat capacity at constant pressure, C_p (hint: use the expression for p to solve for V as a function of T , p , and n ; then use $H = U + pV$)
- 5.5** Figure 5.2 on the next page depicts a hypothetical liquid in equilibrium with its vapor. The liquid and gas are confined in a cylinder by a piston. An electrical resistor is immersed in the liquid. The *system* is the contents of the cylinder to the left of the piston (the liquid, gas, and resistor). The initial state of the system is described by

$$V_1 = 0.2200 \text{ m}^3 \quad T_1 = 300.0 \text{ K} \quad p_1 = 2.50 \times 10^5 \text{ Pa}$$

A constant current $I = 0.5000 \text{ A}$ is passed for 1600 s through the resistor, which has electric resistance $R_{\text{el}} = 50.00 \Omega$. The piston moves slowly to the right against a constant external

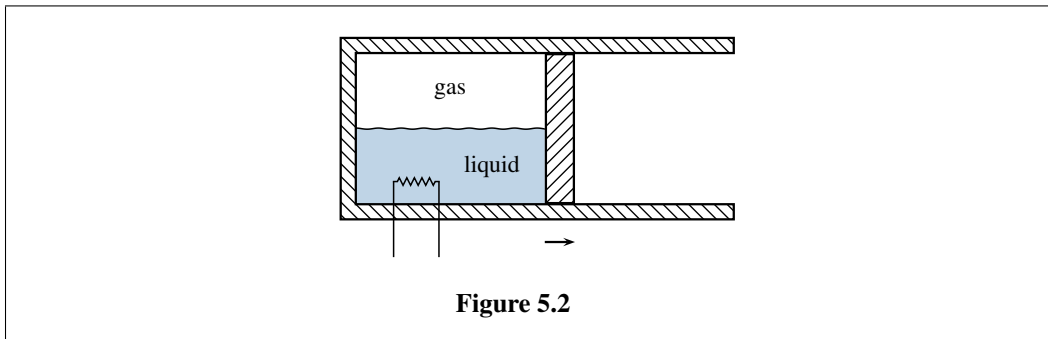

Figure 5.2

pressure equal to the vapor pressure of the liquid, 2.50×10^5 Pa, and some of the liquid vaporizes. Assume that the process is adiabatic and that T and p remain uniform and constant. The final state is described by

$$V_2 = 0.2400 \text{ m}^3 \quad T_2 = 300.0 \text{ K} \quad p_2 = 2.50 \times 10^5 \text{ Pa}$$

- Calculate q , w , ΔU , and ΔH .
- Is the process reversible? Explain.
- Devise a reversible process that accomplishes the same change of state, and use it to calculate ΔS .
- Compare q for the reversible process with ΔH . Does your result agree with Eq. 5.3.8?

Table 5.1 Surface tension of water at 1 bar^a

$t/^\circ\text{C}$	$\gamma/10^{-6} \text{ J cm}^{-2}$
15	7.350
20	7.275
25	7.199
30	7.120
35	7.041

^aRef. [175].

- 5.6** Use the data in Table 5.1 to evaluate $(\partial S/\partial A_s)_{T,p}$ at 25°C , which is the rate at which the entropy changes with the area of the air–water interface at this temperature.
- 5.7** When an ordinary rubber band is hung from a clamp and stretched with constant downward force F by a weight attached to the bottom end, gentle heating is observed to cause the rubber band to contract in length. To keep the length l of the rubber band constant during heating, F must be increased. The stretching work is given by $\delta w' = F dl$. From this information, find the sign of the partial derivative $(\partial T/\partial l)_{S,p}$; then predict whether stretching of the rubber band will cause a heating or a cooling effect.

(Hint: make a Legendre transform of U whose total differential has the independent variables needed for the partial derivative, and write a reciprocity relation.)

You can check your prediction experimentally by touching a rubber band to the side of your face before and after you rapidly stretch it.

CHAPTER 6

THE THIRD LAW AND CRYOGENICS

The third law of thermodynamics concerns the entropy of perfectly-ordered crystals at zero kelvins.

When a chemical reaction or phase transition is studied at low temperatures, and all substances are pure crystals presumed to be perfectly ordered, the entropy change is found to approach zero as the temperature approaches zero kelvins:

$$\lim_{T \rightarrow 0} \Delta S = 0 \quad (6.0.1)$$

(pure, perfectly-ordered crystals)

Equation 6.0.1 is the mathematical statement of the *Nernst heat theorem*¹ or **third law of thermodynamics**. It is true in general only if each reactant and product is a pure crystal with identical unit cells arranged in perfect spatial order.

6.1 The Zero of Entropy

There is no theoretical relation between the entropies of different chemical elements. We can arbitrarily choose the entropy of every pure crystalline element to be zero at zero kelvins. Then the experimental observation expressed by Eq. 6.0.1 requires that the entropy of every pure crystalline *compound* also be zero at zero kelvins, in order that the entropy change for the formation of a compound from its elements will be zero at this temperature.

A classic statement of the third law principle appears in the 1923 book *Thermodynamics and the Free Energy of Chemical Substances* by G. N. Lewis and M. Randall:²

“If the entropy of each element in some crystalline state be taken as zero at the absolute zero of temperature: *every substance has a finite positive entropy, but at the absolute zero of temperature the entropy may become zero, and does so become in the case of perfect crystalline substances.*”

According to this principle, every substance (element or compound) in a pure, perfectly-

¹ Nernst preferred to avoid the use of the entropy function and to use in its place the partial derivative $-(\partial A/\partial T)_V$ (Eq. 5.4.9). The original 1906 version of his heat theorem was in the form $\lim_{T \rightarrow 0} (\partial \Delta A/\partial T)_V = 0$ (Ref. [39]).

²Ref. [110], p. 448.

BIOGRAPHICAL SKETCH

Walther Hermann Nernst (1864–1941)

Walther Nernst was a German physical chemist best known for his heat theorem, also known as the third law of thermodynamics.

Nernst was born in Briesen, West Prussia (now Poland). His father was a district judge.

From all accounts, Nernst was not an easy person to get along with. Gilbert Lewis, who spent a semester in Nernst's laboratory, was one of those who developed an enmity toward him; in later years, Lewis delighted in pointing out what he considered to be errors in Nernst's writings. The American physicist Robert A. Millikan, who studied with Nernst at Göttingen, wrote in a memorial article:^a

He was a little fellow with a fish-like mouth and other well-marked idiosyncrasies. However, he was in the main popular in the laboratory, despite the fact that in the academic world he nearly always had a quarrel on with somebody. He lived on the second floor of the institute with his wife and three young children. As we students came to our work in the morning we would not infrequently meet him in his hunting suit going out for some early morning shooting. . . . His greatest weakness lay in his intense prejudices and the personal, rather than the objective, character of some of his judgments.

At Leipzig University, in 1888, he published the Nernst equation, and in 1890 the Nernst distribution law.

In 1891 he moved to the University of Göttingen, where in 1895 he became director of the Göttingen Physicochemical Institute.

In 1892 Nernst married Emma Lohmeyer, daughter of a Göttingen medical professor.

They had two sons, both killed in World War I, and three daughters.

Nernst wrote an influential textbook of physical chemistry, the second in the field, entitled *Theoretische Chemie vom Standpunkte der Avogadro'schen Regel und der Thermodynamik*. It was first published in 1893 and its last edition was in 1926.

Nernst began work in 1893 on a novel electric incandescent lamp based on solid-state electrolytes. His sale of the patent in 1898 made him wealthy, but the lamp was not commercially successful.

In 1905 Nernst was appointed director of the Berlin Physicochemical Institute; at the end of that year he reported the discovery of his heat theorem.

Nernst was awarded the Nobel Prize in Chemistry for the year 1920 "in recognition of his work in thermochemistry." In his Nobel Lecture, describing the heat theorem, he said:

...in all cases chemical affinity and evolution of heat become identical at low temperatures. Not, and this is the essential point, in the sense that they intersect at absolute zero, but rather in the sense that they invariably become practically identical some distance before absolute zero is reached; in other words the two curves become mutually tangential in the vicinity of absolute zero.

If we frame this principle in quite general terms, i.e. if we apply it not only to chemical but to all processes, then we have the new heat theorem which gives rise to a series of very far-reaching consequences . . .

Nernst would have nothing to do with the Nazis. When they passed the 1933 law barring Jews from state employment, he refused to fire the Jewish scientists at the Berlin institute, and instead took the opportunity to retire. He caused a stir at a meeting by refusing to stand for the singing of the *Horst Wessel Lied*. Before his death he ordered that letters he had received be burned, perhaps to protect his correspondents from the Nazi authorities.^b

^aRef. [124]. ^bRef. [35].

ordered crystal at 0 K, at any pressure,³ has a molar entropy of zero:

$$S_m(0 \text{ K}) = 0 \quad (6.1.1)$$

(pure, perfectly-ordered crystal)

This convention establishes a scale of absolute entropies at temperatures above zero kelvins called **third-law entropies**, as explained in the next section.

6.2 Molar Entropies

With the convention that the entropy of a pure, perfectly-ordered crystalline solid at zero kelvins is zero, we can establish the third-law value of the molar entropy of a pure substance at any temperature and pressure. Absolute values of S_m are what are usually tabulated for calculational use.

6.2.1 Third-law molar entropies

Suppose we wish to evaluate the entropy of an amount n of a pure substance at a certain temperature T' and a certain pressure. The same substance, in a perfectly-ordered crystal at zero kelvins and the same pressure, has an entropy of zero. The entropy at the temperature and pressure of interest, then, is the entropy change $\Delta S = \int_0^{T'} \dot{q}/T$ of a reversible heating process at constant pressure that converts the perfectly-ordered crystal at zero kelvins to the state of interest.

Consider a reversible isobaric heating process of a pure substance while it exists in a single phase. The definition of heat capacity as \dot{q}/dT (Eq. 3.1.9) allows us to substitute $C_p dT$ for \dot{q} , where C_p is the heat capacity of the phase at constant pressure.

If the substance in the state of interest is a liquid or gas, or a crystal of a different form than the perfectly-ordered crystal present at zero kelvins, the heating process will include one or more equilibrium phase transitions under conditions where two phases are in equilibrium at the same temperature and pressure (Sec. 2.2.2). For example, a reversible heating process at a pressure above the triple point that transforms the crystal at 0 K to a gas may involve transitions from one crystal form to another, and also melting and vaporization transitions.

Each such reversible phase transition requires positive heat q_{trs} . Because the pressure is constant, the heat is equal to the enthalpy change (Eq. 5.3.8). The ratio q_{trs}/n is called the molar heat or molar enthalpy of the transition, $\Delta_{\text{trs}}H$ (see Sec. 8.3.1). Because the phase transition is reversible, the entropy change during the transition is given by $\Delta_{\text{trs}}S = q_{\text{trs}}/nT_{\text{trs}}$ where T_{trs} is the transition temperature.

With these considerations, we can write the following expression for the entropy change of the entire heating process:

$$\Delta S = \int_0^{T'} \frac{C_p}{T} dT + \sum \frac{n\Delta_{\text{trs}}H}{T_{\text{trs}}} \quad (6.2.1)$$

³The entropy becomes independent of pressure as T approaches zero kelvins. This behavior can be deduced from the relation $(\partial S/\partial p)_T = -\alpha V$ (Table 7.1 on page 180) combined with the experimental observation that the cubic expansion coefficient α approaches zero as T approaches zero kelvins.

The resulting operational equation for the calculation of the *molar* entropy of the substance at the temperature and pressure of interest is

$$S_m(T') = \frac{\Delta S}{n} = \int_0^{T'} \frac{C_{p,m}}{T} dT + \sum \frac{\Delta_{\text{trs}} H}{T_{\text{trs}}} \quad (6.2.2)$$

(pure substance,
constant p)

where $C_{p,m} = C_p/n$ is the molar heat capacity at constant pressure. The summation is over each equilibrium phase transition occurring during the heating process.

Since $C_{p,m}$ is positive at all temperatures above zero kelvins, and $\Delta_{\text{trs}} H$ is positive for all transitions occurring during a reversible heating process, the molar entropy of a substance is *positive* at all temperatures above zero kelvins.

The heat capacity and transition enthalpy data required to evaluate $S_m(T')$ using Eq. 6.2.2 come from calorimetry. The calorimeter can be cooled to about 10 K with liquid hydrogen, but it is difficult to make measurements below this temperature. Statistical mechanical theory may be used to approximate the part of the integral in Eq. 6.2.2 between zero kelvins and the lowest temperature at which a value of $C_{p,m}$ can be measured. The appropriate formula for nonmagnetic nonmetals comes from the Debye theory for the lattice vibration of a monatomic crystal. This theory predicts that at low temperatures (from 0 K to about 30 K), the molar heat capacity at constant volume is proportional to T^3 : $C_{V,m} = aT^3$, where a is a constant. For a solid, the molar heat capacities at constant volume and at constant pressure are practically equal. Thus for the integral on the right side of Eq. 6.2.2 we can, to a good approximation, write

$$\int_0^{T'} \frac{C_{p,m}}{T} dT = a \int_0^{T''} T^2 dT + \int_{T''}^{T'} \frac{C_{p,m}}{T} dT \quad (6.2.3)$$

where T'' is the lowest temperature at which $C_{p,m}$ is measured. The first term on the right side of Eq. 6.2.3 is

$$a \int_0^{T''} T^2 dT = (aT^3/3)|_0^{T''} = a(T'')^3/3 \quad (6.2.4)$$

But $a(T'')^3$ is the value of $C_{p,m}$ at T'' , so Eq. 6.2.2 becomes

$$S_m(T') = \frac{C_{p,m}(T'')}{3} + \int_{T''}^{T'} \frac{C_{p,m}}{T} dT + \sum \frac{\Delta_{\text{trs}} H}{T_{\text{trs}}} \quad (6.2.5)$$

(pure substance,
constant p)

In the case of a metal, statistical mechanical theory predicts an electronic contribution to the molar heat capacity, proportional to T at low temperature, that should be added to the Debye T^3 term: $C_{p,m} = aT^3 + bT$. The error in using Eq. 6.2.5, which ignores the electronic term, is usually negligible if the heat capacity measurements are made down to about 10 K.

We may evaluate the integral on the right side of Eq. 6.2.5 by numerical integration. We need the area under the curve of $C_{p,m}/T$ plotted as a function of T between some low temperature, T'' , and the temperature T' at which the molar entropy is to be evaluated.

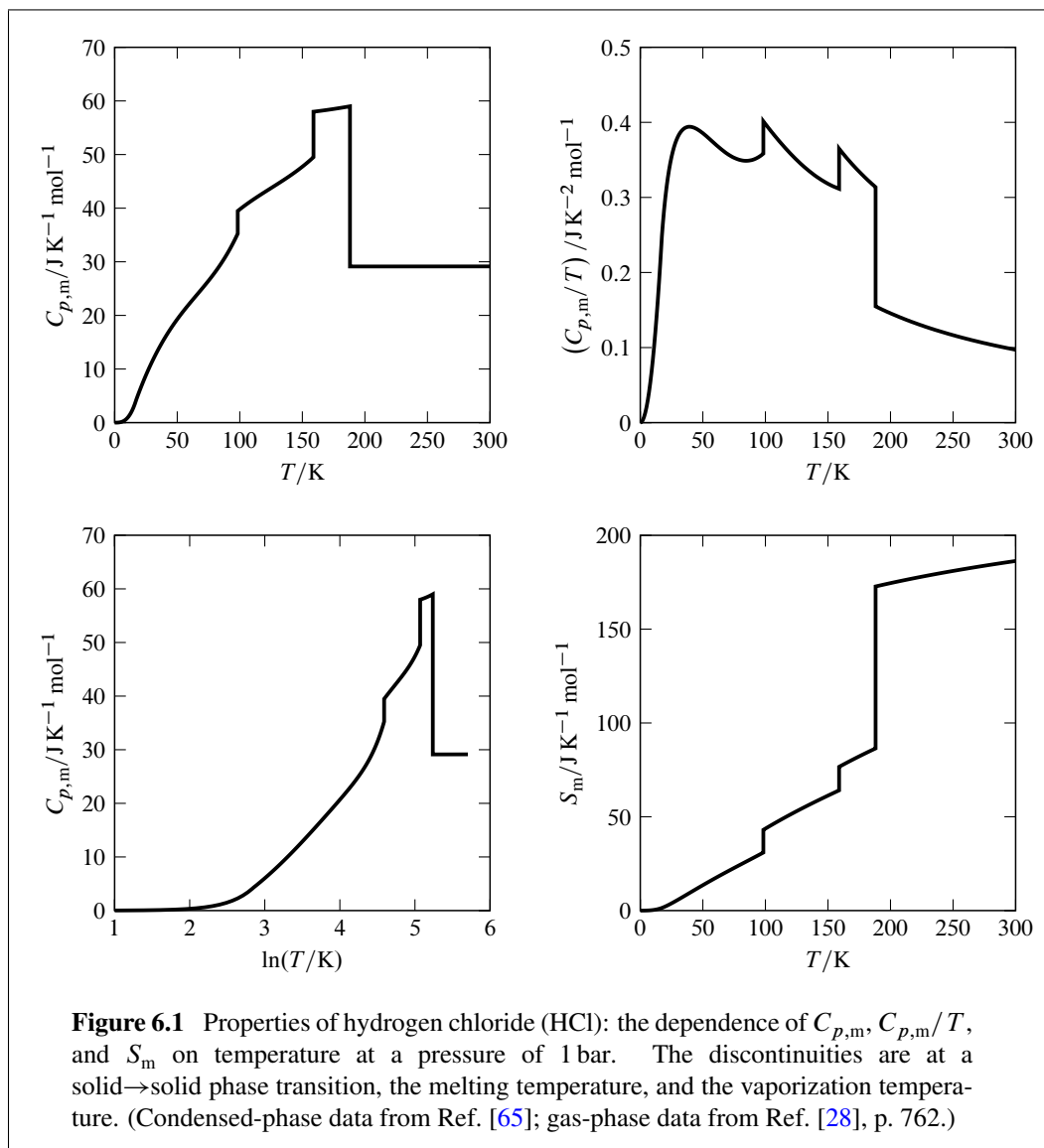

Since the integral may be written in the form

$$\int_{T''}^{T'} \frac{C_{p,m}}{T} dT = \int_{T=T''}^{T=T'} C_{p,m} d \ln(T/K) \quad (6.2.6)$$

we may also evaluate the integral from the area under a curve of $C_{p,m}$ plotted as a function of $\ln(T/K)$.

The procedure of evaluating the entropy from the heat capacity is illustrated for the case of hydrogen chloride in Fig. 6.1. The areas under the curves of $C_{p,m}/T$ versus T , and of $C_{p,m}$ versus $\ln(T/K)$, in a given temperature range are numerically identical (Eq. 6.2.6). Either curve may be used in Eq. 6.2.2 to find the dependence of S_m on T . Note how the molar entropy increases continuously with increasing T and has a discontinuity at each phase transition.

As explained in Sec. 6.1, by convention the zero of entropy of any substance refers to the pure, perfectly-ordered crystal at zero kelvins. In practice, experimental entropy values depart from this convention in two respects. First, an element is usually a mixture of two or more isotopes, so that the substance is not isotopically pure. Second, if any of the nuclei have spins, weak interactions between the nuclear spins in the crystal would cause the spin orientations to become ordered at a very low temperature. Above 1 K, however, the orientation of the nuclear spins become essentially random, and this change of orientation is not included in the Debye T^3 formula.

The neglect of these two effects results in a *practical entropy scale*, or conventional entropy scale, on which the crystal that is assigned an entropy of zero has randomly-mixed isotopes and randomly-oriented nuclear spins, but is pure and ordered in other respects. This is the scale that is used for published values of absolute “third-law” molar entropies. The shift of the zero away from a completely-pure and perfectly-ordered crystal introduces no inaccuracies into the calculated value of ΔS for any process occurring above 1 K, because the shift is the same in the initial and final states. That is, isotopes remain randomly mixed and nuclear spins remain randomly oriented.

6.2.2 Molar entropies from spectroscopic measurements

Statistical mechanical theory applied to spectroscopic measurements provides an accurate means of evaluating the molar entropy of a pure ideal gas from experimental molecular properties. This is often the preferred method of evaluating S_m for a gas. The zero of entropy is the same as the practical entropy scale—that is, isotope mixing and nuclear spin interactions are ignored. Intermolecular interactions are also ignored, which is why the results apply only to an ideal gas.

The statistical mechanics formula writes the molar entropy as the sum of a translational contribution and an internal contribution: $S_m = S_{m,\text{trans}} + S_{m,\text{int}}$. The translational contribution is given by the Sackur–Tetrode equation:

$$S_{m,\text{trans}} = R \ln \frac{(2\pi M)^{3/2} (RT)^{5/2}}{p h^3 N_A^4} + (5/2)R \quad (6.2.7)$$

Here h is the Planck constant and N_A is the Avogadro constant. The internal contribution is given by

$$S_{m,\text{int}} = R \ln q_{\text{int}} + RT(d \ln q_{\text{int}}/dT) \quad (6.2.8)$$

where q_{int} is the molecular partition function defined by

$$q_{\text{int}} = \sum_i \exp(-\epsilon_i/kT) \quad (6.2.9)$$

In Eq. 6.2.9, ϵ_i is the energy of a molecular quantum state relative to the lowest energy level, k is the Boltzmann constant, and the sum is over the quantum states of one molecule with appropriate averaging for natural isotopic abundance. The experimental data needed to evaluate q_{int} consist of the energies of low-lying electronic energy levels, values of electronic degeneracies, fundamental vibrational frequencies, rotational constants, and other spectroscopic parameters.

When the spectroscopic method is used to evaluate S_m with p set equal to the standard pressure $p^\circ = 1$ bar, the value is the *standard* molar entropy, S_m° , of the substance in the gas phase. This value is useful for thermodynamic calculations even if the substance is not an ideal gas at the standard pressure, as will be discussed in Sec. 7.9.

Table 6.1 Standard molar entropies of several substances (ideal gases at $T = 298.15$ K and $p = 1$ bar) and molar residual entropies

Substance	$S_m^\circ/\text{J K}^{-1} \text{ mol}^{-1}$		$S_{m,0}/\text{J K}^{-1} \text{ mol}^{-1}$
	calorimetric	spectroscopic ^a	
HCl	186.3 ± 0.4^b	186.901	0.6 ± 0.4
CO	193.4 ± 0.4^c	197.65 ± 0.04	4.3 ± 0.4
NO	208.0 ± 0.4^d	210.758	2.8 ± 0.4
N ₂ O (NNO)	215.3 ± 0.4^e	219.957	4.7 ± 0.4
H ₂ O	185.4 ± 0.2^f	188.834 ± 0.042	3.4 ± 0.2

^aRef. [28]. ^bRef. [65]. ^cRef. [34]. ^dRef. [90]. ^eRef. [15]. ^fRef. [64].

6.2.3 Residual entropy

Ideally, the molar entropy values obtained by the calorimetric (third-law) method for a gas should agree closely with the values calculated from spectroscopic data. Table 6.1 shows that for some substances this agreement is not present. The table lists values of S_m° for ideal gases at 298.15 K evaluated by both the calorimetric and spectroscopic methods. The quantity $S_{m,0}$ in the last column is the difference between the two S_m° values, and is called the molar *residual entropy*.

In the case of HCl, the experimental value of the residual entropy is comparable to its uncertainty, indicating good agreement between the calorimetric and spectroscopic methods. This agreement is typical of most substances, particularly those like HCl whose molecules are polar and asymmetric with a large energetic advantage of forming perfectly-ordered crystals.

The other substances listed in Table 6.1 have residual entropies that are greater than zero within the uncertainty of the data. What is the meaning of this discrepancy between the calorimetric and spectroscopic results? We can assume that the true values of S_m° at 298.15 K are the *spectroscopic* values, because their calculation assumes the solid has only one microstate at 0 K, with an entropy of zero, and takes into account all of the possible accessible microstates of the ideal gas. The *calorimetric* values, on the other hand, are based on Eq. 6.2.2 which assumes the solid becomes a perfectly-ordered crystal as the temperature approaches 0 K.⁴

The conventional explanation of a nonzero residual entropy is the presence of random rotational orientations of molecules in the solid at the lowest temperature at which the heat capacity can be measured, so that the crystals are not perfectly ordered. The random structure is established as the crystals form from the liquid, and becomes frozen into the crystals as the temperature is lowered below the freezing point. This tends to happen with almost-symmetric molecules with small dipole moments which in the crystal can have random rotational orientations of practically equal energy. In the case of solid H₂O it is the arrangement of intermolecular hydrogen bonds that is random. Crystal imperfections such as dislocations can also contribute to the residual entropy. If such crystal imperfection is

⁴The calorimetric values in Table 6.1 were calculated as follows. Measurements of heat capacities and heats of transition were used in Eq. 6.2.2 to find the third-law value of S_m for the vapor at the boiling point of the substance at $p = 1$ atm. This calculated value for the gas was corrected to that for the ideal gas at $p = 1$ bar and adjusted to $T = 298.15$ K with spectroscopic data.

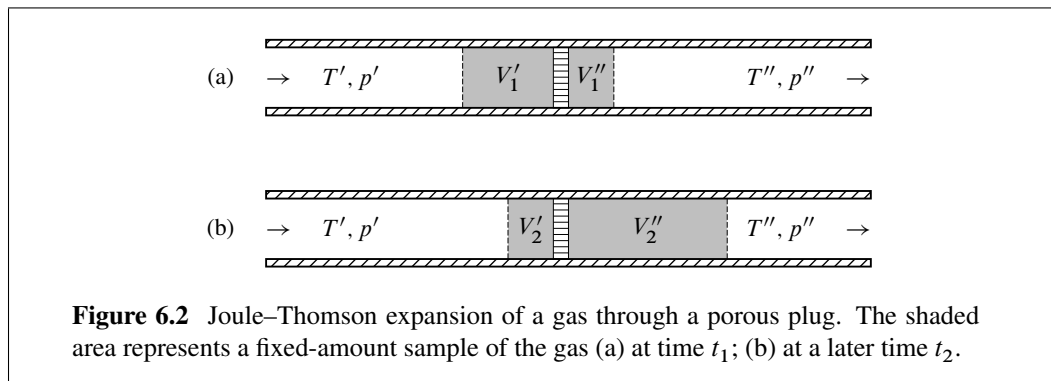

Figure 6.2 Joule–Thomson expansion of a gas through a porous plug. The shaded area represents a fixed-amount sample of the gas (a) at time t_1 ; (b) at a later time t_2 .

present at the lowest experimental temperature, the calorimetric value of S_m° for the gas at 298.15 K is the molar entropy increase for the change at 1 bar from the imperfectly-ordered solid at 0 K to the ideal gas at 298.15 K, and the residual entropy $S_{m,0}$ is the molar entropy of this imperfectly-ordered solid.

6.3 Cryogenics

The field of cryogenics involves the production of very low temperatures, and the study of the behavior of matter at these temperatures. These low temperatures are needed to evaluate third-law entropies using calorimetric measurements. There are some additional interesting thermodynamic applications.

6.3.1 Joule–Thomson expansion

A gas can be cooled by expanding it adiabatically with a piston (Sec. 3.5.3), and a liquid can be cooled by pumping on its vapor to cause evaporation (vaporization). An evaporation procedure with a refrigerant fluid is what produces the cooling in an ordinary kitchen refrigerator.

For further cooling of a fluid, a common procedure is to use a continuous **throttling process** in which the fluid is forced to flow through a porous plug, valve, or other constriction that causes an abrupt drop in pressure. A slow continuous adiabatic throttling of a gas is called the **Joule–Thomson experiment**, or Joule–Kelvin experiment, after the two scientists who collaborated between 1852 and 1862 to design and analyze this procedure.⁵

The principle of the Joule–Thomson experiment is shown in Fig. 6.2. A tube with thermally insulated walls contains a gas maintained at a constant pressure p' at the left side of a porous plug and at a constant lower pressure p'' at the right side. Because of the pressure difference, the gas flows continuously from left to right through the plug. The flow is slow, and the pressure is essentially uniform throughout the portion of the tube at each side of the plug, but has a large gradient within the pores of the plug.

After the gas has been allowed to flow for a period of time, a steady state develops in the tube. In this steady state, the gas is assumed to have a uniform temperature T' at the left side of the plug and a uniform temperature T'' (not necessarily equal to T') at the right side of the plug.

⁵William Thomson later became Lord Kelvin.

Consider the segment of gas whose position at times t_1 and t_2 is indicated by shading in Fig. 6.2. This segment contains a fixed amount of gas and expands as it moves through the porous plug from higher to lower pressure. We can treat this gas segment as a *closed system*. During the interval between times t_1 and t_2 , the system passes through a sequence of different states, none of which is an equilibrium state since the process is irreversible. The energy transferred across the boundary by heat is *zero*, because the tube wall is insulated and there is no temperature gradient at either end of the gas segment. We calculate the energy transferred by work at each end of the gas segment from $\delta w = -p_b A_s dx$, where p_b is the pressure (either p' or p'') at the moving boundary, A_s is the cross-section area of the tube, and x is the distance along the tube. The result is

$$w = -p'(V_2' - V_1') - p''(V_2'' - V_1'') \quad (6.3.1)$$

where the meaning of the volumes V_1' , V_2' , and so on is indicated in the figure.

The internal energy change ΔU of the gas segment must be equal to w , since q is zero. Now let us find the enthalpy change ΔH . At each instant, a portion of the gas segment is in the pores of the plug, but this portion contributes an unchanging contribution to both U and H because of the steady state. The rest of the gas segment is in the portions on either side of the plug, with enthalpies $U' + p'V'$ at the left and $U'' + p''V''$ at the right. The overall enthalpy change of the gas segment must be

$$\Delta H = \Delta U + (p'V_2' + p''V_2'') - (p'V_1' + p''V_1'') \quad (6.3.2)$$

which, when combined with the expression of Eq. 6.3.1 for $w = \Delta U$, shows that ΔH is *zero*. In other words, the gas segment has the same enthalpy before and after it passes through the plug: the throttling process is *isenthalpic*.

The temperatures T' and T'' can be measured directly. When values of T'' versus p'' are plotted for a series of Joule–Thomson experiments having the same values of T' and p' and different values of p'' , the curve drawn through the points is a curve of constant enthalpy. The slope at any point on this curve is equal to the **Joule–Thomson coefficient** (or Joule–Kelvin coefficient) defined by

$$\mu_{JT} \stackrel{\text{def}}{=} \left(\frac{\partial T}{\partial p} \right)_H \quad (6.3.3)$$

For an ideal gas, μ_{JT} is zero because the enthalpy of an ideal gas depends only on T (Prob. 5.1); T cannot change if H is constant. For a *nonideal* gas, μ_{JT} is a function of T and p and the kind of gas.⁶ For most gases, at low to moderate pressures and at temperatures not much greater than room temperature, μ_{JK} is positive. Under these conditions, a Joule–Thomson expansion to a lower pressure has a cooling effect, because T will decrease as p decreases at constant H . Hydrogen and helium, however, have negative values of μ_{JK} at room temperature and must be cooled by other means to about 200 K and 40 K, respectively, in order for a Joule–Thomson expansion to cause further cooling.

The cooling effect of a Joule–Thomson expansion is often used to cool a gas down to its condensation temperature. This procedure can be carried out continuously by pumping the gas through the throttle and recirculating the cooler gas on the low-pressure side through a heat exchanger to help cool the gas on the high-pressure side. Starting at room temperature,

⁶See Sec. 7.5.2 for the relation of the Joule–Thomson coefficient to other properties of a gas.

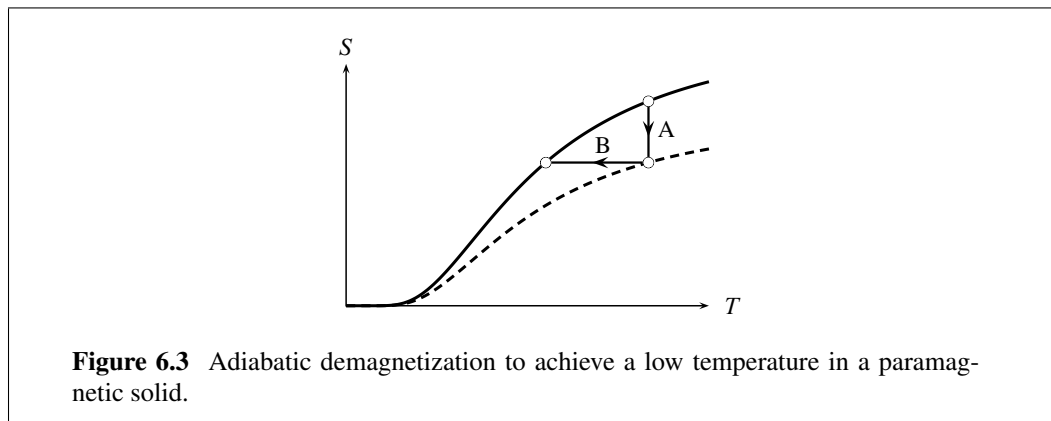

gaseous nitrogen can be condensed by this means to liquid nitrogen at 77.4 K. The liquid nitrogen can then be used as a cooling bath for gaseous hydrogen. At 77.4 K, hydrogen has a positive Joule–Thomson coefficient, so that it in turn can be converted by a throttling process to liquid hydrogen at 20.3 K. Finally, gaseous helium, whose Joule–Thomson coefficient is positive at 20.3 K, can be converted to liquid helium at 4.2 K. Further cooling of the liquid helium to about 1 K can be carried out by pumping to cause rapid evaporation.

6.3.2 Magnetization

The work of magnetization of an isotropic paramagnetic phase can be written $\delta w' = B dm_{\text{mag}}$, where B is the magnitude of the magnetic flux density and m_{mag} is the magnitude of the magnetic dipole moment of the phase. The total differential of the internal energy of a closed isotropic phase with magnetization is given by

$$dU = T dS - p dV + B dm_{\text{mag}} \quad (6.3.4)$$

with S , V , and m_{mag} as the independent variables.

The technique of **adiabatic demagnetization** can be used to obtain temperatures below 1 K. This method, suggested by Peter Debye in 1926 and independently by William Giaque in 1927, requires a paramagnetic solid in which ions with unpaired electrons are sufficiently separated that at 1 K the orientations of the magnetic dipoles are almost completely random. Gadolinium(III) sulfate octahydrate, $\text{Gd}_2(\text{SO}_4)_3 \cdot 8\text{H}_2\text{O}$, is commonly used.

Figure 6.3 illustrates the principle of the technique. The solid curve shows the temperature dependence of the entropy of a paramagnetic solid in the absence of an applied magnetic field, and the dashed curve is for the solid in a constant, finite magnetic field. The temperature range shown is from 0 K to approximately 1 K. At 0 K, the magnetic dipoles are perfectly ordered. The increase of S shown by the solid curve between 0 K and 1 K is due almost entirely to increasing disorder in the orientations of the magnetic dipoles as heat enters the system.

Path A represents the process that occurs when the paramagnetic solid, surrounded by gaseous helium in thermal contact with liquid helium that has been cooled to about 1 K, is slowly moved into a strong magnetic field. The process is *isothermal magnetization*, which partially orients the magnetic dipoles and reduces the entropy. During this process there is heat transfer to the liquid helium, which partially boils away. In path B, the thermal contact

BIOGRAPHICAL SKETCH

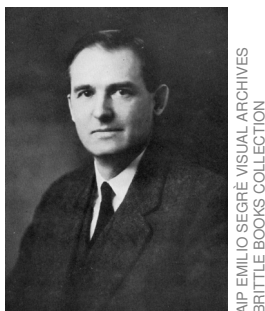
William Francis Giauque (1895–1982)AIP EMILIO SEGRÈ VISUAL ARCHIVES
BRITTLER BOOKS COLLECTION

William Giauque was an American chemist who made important contributions to the field of cryogenics. He received the 1949 Nobel Prize in Chemistry “for his contributions in the field of chemical thermodynamics, particularly concerning the behaviour of substances at extremely low temperatures.”

Giauque was born in Niagara Falls, Ontario, Canada, but as his father was a citizen of the United States, William was able to adopt American citizenship. His father worked as a weighmaster and station agent for the Michigan Central Railroad in Michigan.

Giauque’s initial career goal after high school was electrical engineering. After working for two years at the Hooker Electrochemical Company in Niagara Falls, New York, he left to continue his education with the idea of becoming a chemical engineer. Hearing of the scientific reputation of G. N. Lewis, the chair of the chemistry department at the University of California at Berkeley (page 272), and motivated by the free tuition there, he enrolled instead in that department.^a

Giauque spent the rest of his life in the chemistry department at Berkeley, first as an undergraduate; then as a graduate student; and finally, after receiving his Ph.D. in 1922, as a faculty member. Some of his undergraduate courses were in engineering, which later helped him in the design and construction of the heavy equipment for producing the high magnetic fields and the liquid hydrogen and helium needed in his research.

Beginning in 1928, with the help of his

graduate students and collaborators, he began to publish papers on various aspects of the third law.^b The research included the evaluation of third-law molar entropies and comparison to molar entropies calculated from spectroscopic data, and the study of the residual entropy of crystals. Faint unexplained lines in the absorption spectrum of gaseous oxygen led him to the discovery of the previously unknown ¹⁷O and ¹⁸O isotopes of oxygen.

Giauque’s best-known accomplishment is his invention and exploitation of cooling to very low temperatures by adiabatic demagnetization. In 1924, he learned of the unusual properties of gadolinium sulfate octahydrate at the temperature of liquid helium. In his Nobel Lecture, he said:^c

I was greatly surprised to find, that the application of a magnetic field removes a large amount of entropy from this substance, at a temperature so low that it had been thought that there was practically no entropy left to remove. . . . Those familiar with thermodynamics will realize that in principle any process involving an entropy change may be used to produce either cooling or heating. Accordingly it occurred to me that adiabatic demagnetization could be made the basis of a method for producing temperatures lower than those obtainable with liquid helium.

It wasn’t until 1933 that he was able to build the equipment and publish the results from his first adiabatic demagnetization experiment, reporting a temperature of 0.25 K.^d

He was married to a botanist and had two sons. According to one biography:^e

Giauque’s students remember pleasant Thanksgiving dinners at the Giauque home, with Muriel [his wife] as cook and Frank (as she called him) as raconteur, with a keen sense of humor. The stories he most enjoyed telling were those in which the joke was on him. . . . Giauque’s conservatism was legendary. He always appeared at the university dressed in an iron-gray tweed suit. . . . A dominant personality himself, Giauque not only tolerated but respected students who disagreed with him, and he was especially pleased when they could prove their point.

^aRef. [142]. ^bRef. [166]. ^cRef. [66]. ^dRef. [63]. ^eRef. [142].

between the solid and the liquid helium has been broken by pumping away the gas surrounding the solid, and the sample is slowly moved away from the magnetic field. This step is a reversible adiabatic demagnetization. Because the process is reversible and adiabatic, the entropy change is zero, which brings the state of the solid to a lower temperature as shown.

The sign of $(\partial T/\partial B)_{S,p}$ is of interest because it tells us the sign of the temperature change during a reversible adiabatic demagnetization (path B of Fig. 6.3 on page 162). To change the independent variables in Eq. 6.3.4 to S , p , and B , we define the Legendre transform

$$H' \stackrel{\text{def}}{=} U + pV - Bm_{\text{mag}} \quad (6.3.5)$$

(H' is sometimes called the *magnetic enthalpy*.) From Eqs. 6.3.4 and 6.3.5 we obtain the total differential

$$dH' = T dS + V dp - m_{\text{mag}} dB \quad (6.3.6)$$

From it we find the reciprocity relation

$$\left(\frac{\partial T}{\partial B}\right)_{S,p} = -\left(\frac{\partial m_{\text{mag}}}{\partial S}\right)_{p,B} \quad (6.3.7)$$

According to Curie's law of magnetization, the magnetic dipole moment m_{mag} of a paramagnetic phase at constant magnetic flux density B is proportional to $1/T$. This law applies when B is small, but even if B is not small m_{mag} decreases with increasing T . To increase the temperature of a phase at constant B , we allow heat to enter the system, and S then increases. Thus, $(\partial m_{\text{mag}}/\partial S)_{p,B}$ is negative and, according to Eq. 6.3.7, $(\partial T/\partial B)_{S,p}$ must be positive. Adiabatic demagnetization is a constant-entropy process in which B decreases, and therefore the temperature also *decreases*.

We can find the sign of the entropy change during the isothermal magnetization process shown as path A in Fig. 6.3 on page 162. In order to use T , p , and B as the independent variables, we define the Legendre transform $G' \stackrel{\text{def}}{=} H' - TS$. Its total differential is

$$dG' = -S dT + V dp - m_{\text{mag}} dB \quad (6.3.8)$$

From this total differential, we obtain the reciprocity relation

$$\left(\frac{\partial S}{\partial B}\right)_{T,p} = \left(\frac{\partial m_{\text{mag}}}{\partial T}\right)_{p,B} \quad (6.3.9)$$

Since m_{mag} at constant B decreases with increasing T , as explained above, we see that the entropy change during isothermal magnetization is *negative*.

By repeatedly carrying out a procedure of isothermal magnetization and adiabatic demagnetization, starting each stage at the temperature produced by the previous stage, it has been possible to attain a temperature as low as 0.0015 K. The temperature can be reduced still further, down to 16 microkelvins, by using adiabatic nuclear demagnetization. However, as is evident from the figure, if in accordance with the third law both of the entropy curves come together at the absolute zero of the kelvin scale, then it is not possible to attain a temperature of zero kelvins in a finite number of stages of adiabatic demagnetization. This conclusion is called the *principle of the unattainability of absolute zero*.

PROBLEM

6.1 Calculate the molar entropy of carbon disulfide at 25.00 °C and 1 bar from the heat capacity data for the solid in Table 6.2 and the following data for $p = 1$ bar. At the melting point,

Table 6.2 Molar heat capacity of CS₂(s) at $p = 1$ bar^a

T/K	$C_{p,m}/\text{J K}^{-1} \text{mol}^{-1}$
15.05	6.9
20.15	12.0
29.76	20.8
42.22	29.2
57.52	35.6
75.54	40.0
94.21	45.0
108.93	48.5
131.54	52.6
156.83	56.6

^aRef. [25].

161.11 K, the molar enthalpy of fusion is $\Delta_{\text{fus}}H = 4.39 \times 10^3 \text{ J mol}^{-1}$. The molar heat capacity of the liquid in the range 161–300 K is described by $C_{p,m} = a + bT$, where the constants have the values $a = 74.6 \text{ J K}^{-1} \text{ mol}^{-1}$ and $b = 0.0034 \text{ J K}^{-2} \text{ mol}^{-1}$.

PURE SUBSTANCES IN SINGLE PHASES

This chapter applies concepts introduced in earlier chapters to the simplest kind of system, one consisting of a pure substance or a single component in a single phase. The system has three independent variables if it is open, and two if it is closed. Relations among various properties of a single phase are derived, including temperature, pressure, and volume. The important concepts of standard states and chemical potential are introduced.

7.1 Volume Properties

Two volume properties of a closed system are defined as follows:

$$\text{cubic expansion coefficient} \quad \alpha \stackrel{\text{def}}{=} \frac{1}{V} \left(\frac{\partial V}{\partial T} \right)_p \quad (7.1.1)$$

$$\text{isothermal compressibility} \quad \kappa_T \stackrel{\text{def}}{=} -\frac{1}{V} \left(\frac{\partial V}{\partial p} \right)_T \quad (7.1.2)$$

The cubic expansion coefficient is also called the coefficient of thermal expansion and the expansivity coefficient. Other symbols for the isothermal compressibility are β and γ_T .

These definitions show that α is the fractional volume increase per unit temperature increase at constant pressure, and κ_T is the fractional volume decrease per unit pressure increase at constant temperature. Both quantities are *intensive* properties. Most substances have positive values of α ,¹ and all substances have positive values of κ_T , because a pressure increase at constant temperature requires a volume decrease.

If an amount n of a substance is in a single phase, we can divide the numerator and denominator of the right sides of Eqs. 7.1.1 and 7.1.2 by n to obtain the alternative expressions

¹The cubic expansion coefficient is not always positive. α is negative for liquid water below its temperature of maximum density, 3.98 °C. The crystalline ceramics zirconium tungstate (ZrW_2O_8) and hafnium tungstate (HfW_2O_8) have the remarkable behavior of contracting uniformly and continuously in all three dimensions when they are heated from 0.3 K to about 1050 K; α is negative throughout this very wide temperature range (Ref. [117]). The intermetallic compound YbGaGe has been found to have a value of α that is practically zero in the range 100–300 K (Ref. [158]).

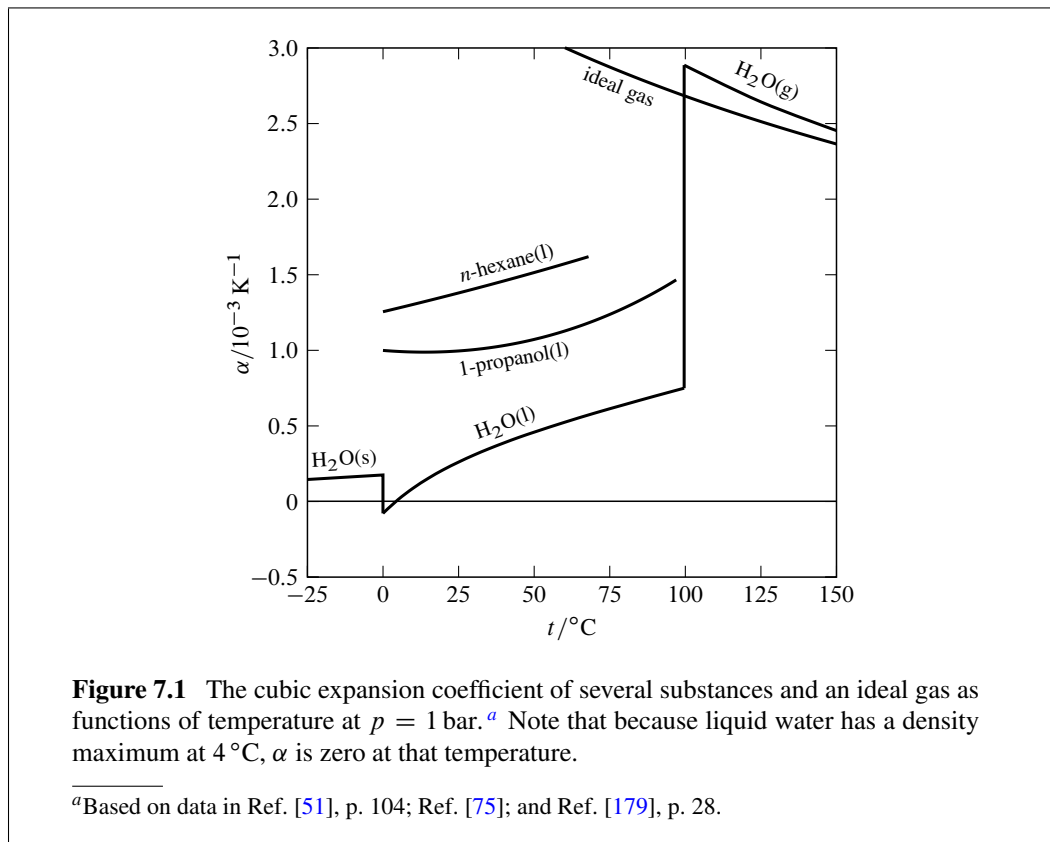

$$\alpha = \frac{1}{V_m} \left(\frac{\partial V_m}{\partial T} \right)_p \quad (7.1.3)$$

(pure substance, $P=1$)

$$\kappa_T = -\frac{1}{V_m} \left(\frac{\partial V_m}{\partial p} \right)_T \quad (7.1.4)$$

(pure substance, $P=1$)

where V_m is the molar volume. P in the conditions of validity is the number of phases. Note that only intensive properties appear in Eqs. 7.1.3 and 7.1.4; the amount of the substance is irrelevant. Figures 7.1 and 7.2 show the temperature variation of α and κ_T for several substances.

If we choose T and p as the independent variables of the closed system, the total differential of V is given by

$$dV = \left(\frac{\partial V}{\partial T} \right)_p dT + \left(\frac{\partial V}{\partial p} \right)_T dp \quad (7.1.5)$$

With the substitutions $(\partial V/\partial T)_p = \alpha V$ (from Eq. 7.1.1) and $(\partial V/\partial p)_T = -\kappa_T V$ (from Eq. 7.1.2), the expression for the total differential of V becomes

$$dV = \alpha V dT - \kappa_T V dp \quad (7.1.6)$$

(closed system,
 $C=1, P=1$)

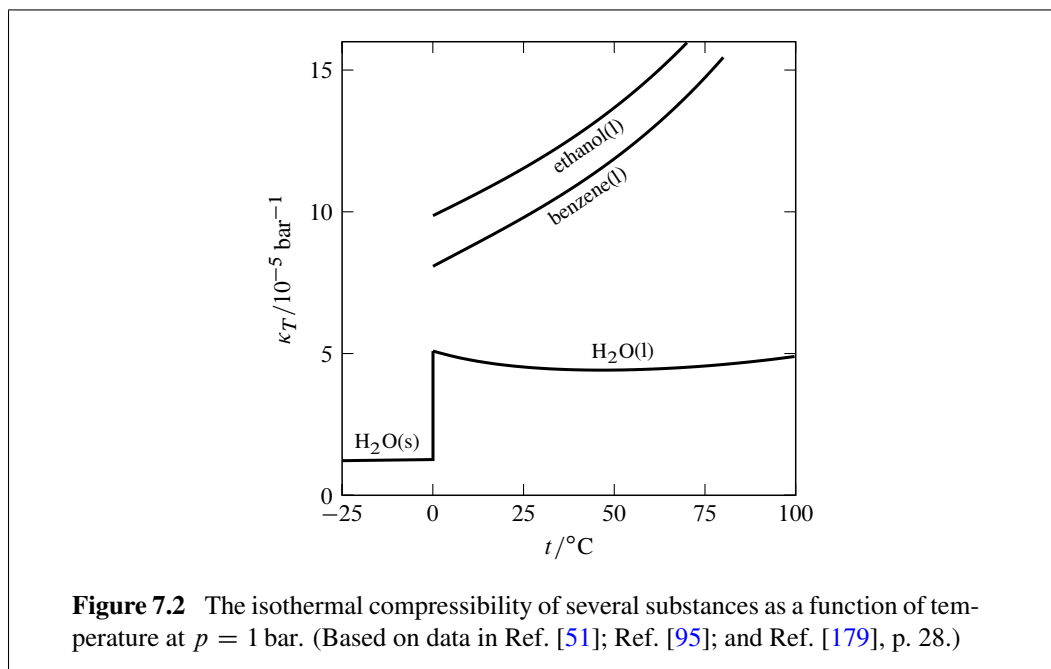

Figure 7.2 The isothermal compressibility of several substances as a function of temperature at $p = 1$ bar. (Based on data in Ref. [51]; Ref. [95]; and Ref. [179], p. 28.)

To find how p varies with T in a closed system kept at constant volume, we set dV equal to zero in Eq. 7.1.6: $0 = \alpha V dT - \kappa_T V dp$, or $dp/dT = \alpha/\kappa_T$. Since dp/dT under the condition of constant volume is the partial derivative $(\partial p/\partial T)_V$, we have the general relation

$$\left(\frac{\partial p}{\partial T}\right)_V = \frac{\alpha}{\kappa_T} \quad (7.1.7)$$

(closed system,
 $C=1, P=1$)

7.2 Internal Pressure

The partial derivative $(\partial U/\partial V)_T$ applied to a fluid phase in a closed system is called the **internal pressure**. (Note that U and pV have dimensions of energy; therefore, U/V has dimensions of pressure.)

To relate the internal pressure to other properties, we divide Eq. 5.2.2 by dV : $dU/dV = T(dS/dV) - p$. Then we impose a condition of constant T : $(\partial U/\partial V)_T = T(\partial S/\partial V)_T - p$. When we make a substitution for $(\partial S/\partial V)_T$ from the Maxwell relation of Eq. 5.4.17, we obtain

$$\left(\frac{\partial U}{\partial V}\right)_T = T \left(\frac{\partial p}{\partial T}\right)_V - p \quad (7.2.1)$$

(closed system,
fluid phase, $C=1$)

This equation is sometimes called the “thermodynamic equation of state” of the fluid.

For an ideal-gas phase, we can write $p = nRT/V$ and then

$$\left(\frac{\partial p}{\partial T}\right)_V = \frac{nR}{V} = \frac{p}{T} \quad (7.2.2)$$

Making this substitution in Eq. 7.2.1 gives us

$$\left(\frac{\partial U}{\partial V}\right)_T = 0 \quad (7.2.3)$$

(closed system of an ideal gas)

showing that the internal pressure of an ideal gas is zero.

In Sec. 3.5.1, an ideal gas was defined as a gas (1) that obeys the ideal gas equation, and (2) for which U in a closed system depends only on T . Equation 7.2.3, derived from the first part of this definition, expresses the second part. It thus appears that the second part of the definition is redundant, and that we could define an ideal gas simply as a gas obeying the ideal gas equation. This argument is valid only if we assume the ideal-gas temperature is the same as the thermodynamic temperature (Secs. 2.3.6 and 4.3.4) since this assumption is required to derive Eq. 7.2.3. Without this assumption, we can't define an ideal gas solely by $pV = nRT$, where T is the ideal gas temperature.

Here is a simplified interpretation of the significance of the internal pressure. When the volume of a fluid increases, the average distance between molecules increases and the potential energy due to intermolecular forces changes. If attractive forces dominate, as they usually do unless the fluid is highly compressed, expansion causes the potential energy to *increase*. The internal energy is the sum of the potential energy and thermal energy. The internal pressure, $(\partial U/\partial V)_T$, is the rate at which the internal energy changes with volume at constant temperature. At constant temperature, the thermal energy is constant so that the internal pressure is the rate at which just the potential energy changes with volume. Thus, the internal pressure is a measure of the strength of the intermolecular forces and is positive if attractive forces dominate.² In an ideal gas, intermolecular forces are absent and therefore the internal pressure of an ideal gas is zero.

With the substitution $(\partial p/\partial T)_V = \alpha/\kappa_T$ (Eq. 7.1.7), Eq. 7.2.1 becomes

$$\left(\frac{\partial U}{\partial V}\right)_T = \frac{\alpha T}{\kappa_T} - p \quad (7.2.4)$$

(closed system,
fluid phase, $C=1$)

The internal pressure of a liquid at $p = 1$ bar is typically much larger than 1 bar (see Prob. 7.6). Equation 7.2.4 shows that, in this situation, the internal pressure is approximately equal to $\alpha T/\kappa_T$.

7.3 Thermal Properties

For convenience in derivations to follow, expressions from Chap. 5 are repeated here that apply to processes in a closed system in the absence of nonexpansion work (i.e., $\delta w' = 0$). For a process at *constant volume* we have³

$$dU = \delta q \quad C_V = \left(\frac{\partial U}{\partial T}\right)_V \quad (7.3.1)$$

²These attractive intermolecular forces are the cohesive forces that can allow a negative pressure to exist in a liquid; see page 40. ³Eqs. 5.3.9 and 5.6.1.

and for a process at *constant pressure* we have⁴

$$dH = \delta q \quad C_p = \left(\frac{\partial H}{\partial T} \right)_p \quad (7.3.2)$$

A closed system of one component in a single phase has only two independent variables. In such a system, the partial derivatives above are complete and unambiguous definitions of C_V and C_p because they are expressed with two independent variables— T and V for C_V , and T and p for C_p . As mentioned on page 146, additional conditions would have to be specified to define C_V for a more complicated system; the same is true for C_p .

For a closed system of an *ideal gas* we have⁵

$$C_V = \frac{dU}{dT} \quad C_p = \frac{dH}{dT} \quad (7.3.3)$$

7.3.1 The relation between $C_{V,m}$ and $C_{p,m}$

The value of $C_{p,m}$ for a substance is greater than $C_{V,m}$. The derivation is simple in the case of a fixed amount of an *ideal gas*. Using substitutions from Eq. 7.3.3, we write

$$C_p - C_V = \frac{dH}{dT} - \frac{dU}{dT} = \frac{d(H - U)}{dT} = \frac{d(pV)}{dT} = nR \quad (7.3.4)$$

Division by n to obtain molar quantities and rearrangement then gives

$$C_{p,m} = C_{V,m} + R \quad (7.3.5)$$

(ideal gas, pure substance)

For any phase in general, we proceed as follows. First we write

$$C_p = \left(\frac{\partial H}{\partial T} \right)_p = \left[\frac{\partial(U + pV)}{\partial T} \right]_p = \left(\frac{\partial U}{\partial T} \right)_p + p \left(\frac{\partial V}{\partial T} \right)_p \quad (7.3.6)$$

Then we write the total differential of U with T and V as independent variables and identify one of the coefficients as C_V :

$$dU = \left(\frac{\partial U}{\partial T} \right)_V dT + \left(\frac{\partial U}{\partial V} \right)_T dV = C_V dT + \left(\frac{\partial U}{\partial V} \right)_T dV \quad (7.3.7)$$

When we divide both sides of the preceding equation by dT and impose a condition of constant p , we obtain

$$\left(\frac{\partial U}{\partial T} \right)_p = C_V + \left(\frac{\partial U}{\partial V} \right)_T \left(\frac{\partial V}{\partial T} \right)_p \quad (7.3.8)$$

Substitution of this expression for $(\partial U/\partial T)_p$ in the equation for C_p yields

$$C_p = C_V + \left[\left(\frac{\partial U}{\partial V} \right)_T + p \right] \left(\frac{\partial V}{\partial T} \right)_p \quad (7.3.9)$$

⁴Eqs. 5.3.7 and 5.6.3. ⁵Eqs. 5.6.2 and 5.6.4.

Finally we set the partial derivative $(\partial U/\partial V)_T$ (the internal pressure) equal to $(\alpha T/\kappa_T) - p$ (Eq. 7.2.4) and $(\partial V/\partial T)_p$ equal to αV to obtain

$$C_p = C_V + \frac{\alpha^2 T V}{\kappa_T} \quad (7.3.10)$$

and divide by n to obtain molar quantities:

$$C_{p,m} = C_{V,m} + \frac{\alpha^2 T V_m}{\kappa_T} \quad (7.3.11)$$

Since the quantity $\alpha^2 T V_m/\kappa_T$ must be positive, $C_{p,m}$ is greater than $C_{V,m}$.

7.3.2 The measurement of heat capacities

The most accurate method of evaluating the heat capacity of a phase is by measuring the temperature change resulting from heating with electrical work. The procedure in general is called calorimetry, and the apparatus containing the phase of interest and the electric heater is a **calorimeter**. The principles of three commonly-used types of calorimeters with electrical heating are described below.

Adiabatic calorimeters

An adiabatic calorimeter is designed to have negligible heat flow to or from its surroundings. The calorimeter contains the phase of interest, kept at either constant volume or constant pressure, and also an electric heater and a temperature-measuring device such as a platinum resistance thermometer, thermistor, or quartz crystal oscillator. The contents may be stirred to ensure temperature uniformity.

To minimize conduction and convection, the calorimeter usually is surrounded by a jacket separated by an air gap or an evacuated space. The outer surface of the calorimeter and inner surface of the jacket may be polished to minimize radiation emission from these surfaces. These measures, however, are not sufficient to ensure a completely adiabatic boundary, because energy can be transferred by heat along the mounting hardware and through the electrical leads. Therefore, the temperature of the jacket, or of an outer metal shield, is adjusted throughout the course of the experiment so as to be as close as possible to the varying temperature of the calorimeter. This goal is most easily achieved when the temperature change is slow.

To make a heat capacity measurement, a constant electric current is passed through the heater circuit for a known period of time. The *system* is the calorimeter and its contents. The electrical work w_{el} performed on the system by the heater circuit is calculated from the integrated form of Eq. 3.8.5 on page 91: $w_{el} = I^2 R_{el} \Delta t$, where I is the electric current, R_{el} is the electric resistance, and Δt is the time interval. We assume the boundary is adiabatic and write the first law in the form

$$dU = -p dV + \dot{w}_{el} + \dot{w}_{cont} \quad (7.3.12)$$

where $-p dV$ is expansion work and w_{cont} is any continuous mechanical work from stirring (the subscript “cont” stands for continuous). If electrical work is done on the system by a

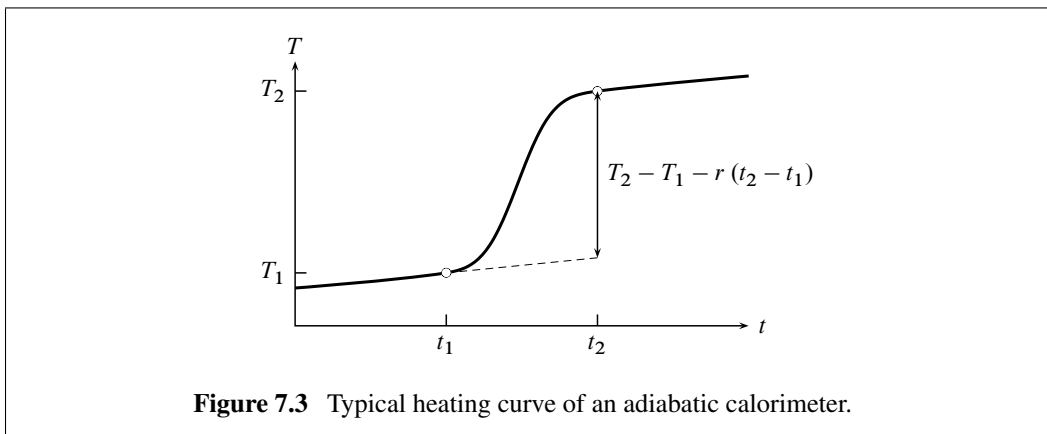

Figure 7.3 Typical heating curve of an adiabatic calorimeter.

thermometer using an external electrical circuit, such as a platinum resistance thermometer, this work is included in w_{cont} .

Consider first an adiabatic calorimeter in which the heating process is carried out at *constant volume*. There is no expansion work, and Eq. 7.3.12 becomes

$$dU = \delta w_{\text{el}} + \delta w_{\text{cont}} \quad (7.3.13)$$

(constant V)

An example of a measured heating curve (temperature T as a function of time t) is shown in Fig. 7.3. We select two points on the heating curve, indicated in the figure by open circles. Time t_1 is at or shortly before the instant the heater circuit is closed and electrical heating begins, and time t_2 is after the heater circuit has been opened and the slope of the curve has become essentially constant.

In the time periods before t_1 and after t_2 , the temperature may exhibit a slow rate of increase due to the continuous work w_{cont} from stirring and temperature measurement. If this work is performed at a constant rate throughout the course of the experiment, the slope is constant and the same in both time periods as shown in the figure.

The relation between the slope and the rate of work is given by a quantity called the **energy equivalent**, ϵ . The energy equivalent is the heat capacity of the calorimeter under the conditions of an experiment. The heat capacity of a constant-volume calorimeter is given by $\epsilon = (\partial U / \partial T)_V$ (Eq. 5.6.1). Thus, at times before t_1 or after t_2 , when δw_{el} is zero and dU equals δw_{cont} , the slope r of the heating curve is given by

$$r = \frac{dT}{dt} = \frac{dT}{dU} \frac{dU}{dt} = \frac{1}{\epsilon} \frac{\delta w_{\text{cont}}}{dt} \quad (7.3.14)$$

The rate of the continuous work is therefore $\delta w_{\text{cont}} / dt = \epsilon r$. This rate is constant throughout the experiment. In the time interval from t_1 to t_2 , the total quantity of continuous work is $w_{\text{cont}} = \epsilon r(t_2 - t_1)$, where r is the slope of the heating curve measured *outside* this time interval.

To find the energy equivalent, we integrate Eq. 7.3.13 between the two points on the curve:

$$\Delta U = w_{\text{el}} + w_{\text{cont}} = w_{\text{el}} + \epsilon r(t_2 - t_1) \quad (7.3.15)$$

(constant V)

Then the average heat capacity between temperatures T_1 and T_2 is

$$\epsilon = \frac{\Delta U}{T_2 - T_1} = \frac{w_{\text{el}} + \epsilon r(t_2 - t_1)}{T_2 - T_1} \quad (7.3.16)$$

Solving for ϵ , we obtain

$$\epsilon = \frac{w_{\text{el}}}{T_2 - T_1 - r(t_2 - t_1)} \quad (7.3.17)$$

The value of the denominator on the right side is indicated by the vertical line in Fig. 7.3. It is the temperature change that would have been observed if the same quantity of electrical work had been performed without the continuous work.

Next, consider the heating process in a calorimeter at *constant pressure*. In this case the enthalpy change is given by $dH = dU + p dV$ which, with substitution from Eq. 7.3.12, becomes

$$dH = \delta w_{\text{el}} + \delta w_{\text{cont}} \quad (7.3.18)$$

(constant p)

We follow the same procedure as for the constant-volume calorimeter, using Eq. 7.3.18 in place of Eq. 7.3.13 and equating the energy equivalent ϵ to $(\partial H/\partial T)_p$, the heat capacity of the calorimeter at constant pressure (Eq. 5.6.3). We obtain the relation

$$\Delta H = w_{\text{el}} + w_{\text{cont}} = w_{\text{el}} + \epsilon r(t_2 - t_1) \quad (7.3.19)$$

(constant p)

in place of Eq. 7.3.15 and end up again with the expression of Eq. 7.3.17 for ϵ .

The value of ϵ calculated from Eq. 7.3.17 is an *average* value for the temperature interval from T_1 to T_2 , and we can identify this value with the heat capacity at the temperature of the midpoint of the interval. By taking the difference of values of ϵ measured with and without the phase of interest present in the calorimeter, we obtain C_V or C_p for the phase alone.

It may seem paradoxical that we can use an adiabatic process, one without heat, to evaluate a quantity defined by heat (heat capacity = $\delta q/dT$). The explanation is that energy transferred into the adiabatic calorimeter as electrical work, and dissipated completely to thermal energy, substitutes for the heat that would be needed for the same change of state without electrical work.

Isothermal-jacket calorimeters

A second common type of calorimeter is similar in construction to an adiabatic calorimeter, except that the surrounding jacket is maintained at constant temperature. It is sometimes called an *isoperibol calorimeter*. A correction is made for heat transfer resulting from the difference in temperature across the gap separating the jacket from the outer surface of the calorimeter. It is important in making this correction that the outer surface have a uniform temperature without "hot spots."

Assume the outer surface of the calorimeter has a uniform temperature T that varies with time, the jacket temperature has a constant value T_{ext} , and convection has been eliminated by evacuating the gap. Then heat transfer is by conduction and radiation, and its rate

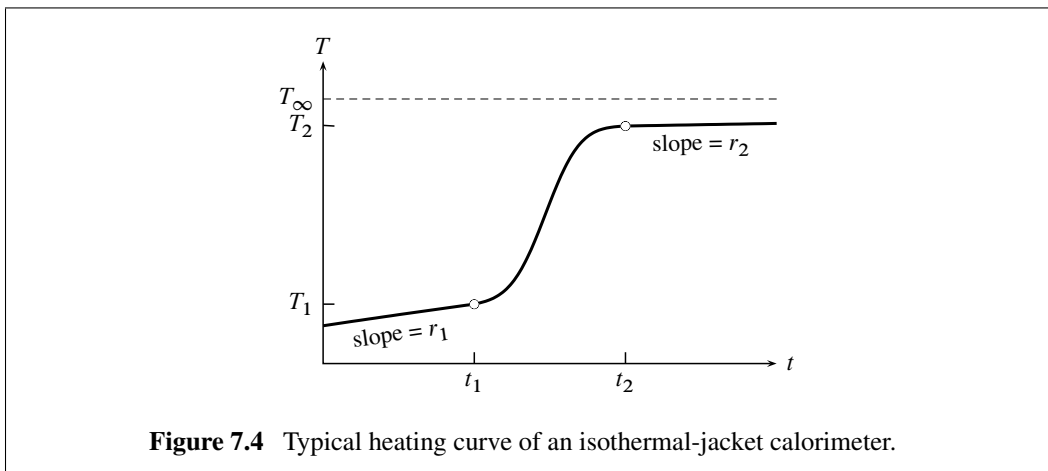

Figure 7.4 Typical heating curve of an isothermal-jacket calorimeter.

is given by Newton's law of cooling

$$\frac{\dot{d}q}{dt} = -k(T - T_{\text{ext}}) \quad (7.3.20)$$

where k is a constant (the thermal conductance). Heat flows from a warmer to a cooler body, so $\dot{d}q/dt$ is positive if T is less than T_{ext} and negative if T is greater than T_{ext} .

The possible kinds of work are the same as for the adiabatic calorimeter: expansion work $-p dV$, intermittent work w_{el} done by the heater circuit, and continuous work w_{cont} . By combining the first law and Eq. 7.3.20, we obtain the following relation for the rate at which the internal energy changes:

$$\frac{dU}{dt} = \frac{\dot{d}q}{dt} + \frac{\dot{d}w}{dt} = -k(T - T_{\text{ext}}) - p \frac{dV}{dt} + \frac{\dot{d}w_{\text{el}}}{dt} + \frac{\dot{d}w_{\text{cont}}}{dt} \quad (7.3.21)$$

For heating at constant *volume* ($dV/dt = 0$), this relation becomes

$$\frac{dU}{dt} = -k(T - T_{\text{ext}}) + \frac{\dot{d}w_{\text{el}}}{dt} + \frac{\dot{d}w_{\text{cont}}}{dt} \quad (7.3.22)$$

(constant V)

An example of a heating curve is shown in Fig. 7.4. In contrast to the curve of Fig. 7.3, the slopes are different before and after the heating interval due to the changed rate of heat flow. Times t_1 and t_2 are before and after the heater circuit is closed. In any time interval before time t_1 or after time t_2 , the system behaves as if it is approaching a steady state of constant temperature T_{∞} (called the convergence temperature), which it would eventually reach if the experiment were continued without closing the heater circuit. T_{∞} is greater than T_{ext} because of the energy transferred to the system by stirring and electrical temperature measurement. By setting dU/dt and $\dot{d}w_{\text{el}}/dt$ equal to zero and T equal to T_{∞} in Eq. 7.3.22, we obtain $\dot{d}w_{\text{cont}}/dt = k(T_{\infty} - T_{\text{ext}})$. We assume $\dot{d}w_{\text{cont}}/dt$ is constant. Substituting this expression into Eq. 7.3.22 gives us a general expression for the rate at which U changes in terms of the unknown quantities k and T_{∞} :

$$\frac{dU}{dt} = -k(T - T_{\infty}) + \frac{\dot{d}w_{\text{el}}}{dt} \quad (7.3.23)$$

(constant V)

This relation is valid throughout the experiment, not only while the heater circuit is closed. If we multiply by dt and integrate from t_1 to t_2 , we obtain the internal energy change in the time interval from t_1 to t_2 :

$$\Delta U = -k \int_{t_1}^{t_2} (T - T_\infty) dt + w_{\text{el}} \quad (7.3.24)$$

(constant V)

All the intermittent work w_{el} is performed in this time interval.

The derivation of Eq. 7.3.24 is a general one. The equation can be applied also to a isothermal-jacket calorimeter in which a reaction is occurring. Section 11.5.2 will mention the use of this equation for an internal energy correction of a reaction calorimeter with an isothermal jacket.

The average value of the energy equivalent in the temperature range T_1 to T_2 is

$$\epsilon = \frac{\Delta U}{T_2 - T_1} = \frac{-\epsilon(k/\epsilon) \int_{t_1}^{t_2} (T - T_\infty) dt + w_{\text{el}}}{T_2 - T_1} \quad (7.3.25)$$

Solving for ϵ , we obtain

$$\epsilon = \frac{w_{\text{el}}}{(T_2 - T_1) + (k/\epsilon) \int_{t_1}^{t_2} (T - T_\infty) dt} \quad (7.3.26)$$

The value of w_{el} is known from $w_{\text{el}} = I^2 R_{\text{el}} \Delta t$, where Δt is the time interval during which the heater circuit is closed. The integral can be evaluated numerically once T_∞ is known.

For heating at constant *pressure*, dH is equal to $dU + p dV$, and we can write

$$\frac{dH}{dt} = \frac{dU}{dt} + p \frac{dV}{dt} = -k(T - T_{\text{ext}}) + \frac{dw_{\text{el}}}{dt} + \frac{dw_{\text{cont}}}{dt} \quad (7.3.27)$$

(constant p)

which is analogous to Eq. 7.3.22. By the procedure described above for the case of constant V , we obtain

$$\Delta H = -k \int_{t_1}^{t_2} (T - T_\infty) dt + w_{\text{el}} \quad (7.3.28)$$

(constant p)

At constant p , the energy equivalent is equal to $C_p = \Delta H/(T_2 - T_1)$, and the final expression for ϵ is the same as that given by Eq. 7.3.26.

To obtain values of k/ϵ and T_∞ for use in Eq. 7.3.26, we need the slopes of the heating curve in time intervals (rating periods) just before t_1 and just after t_2 . Consider the case of constant *volume*. In these intervals, dw_{el}/dt is zero and dU/dt equals $-k(T - T_\infty)$ (from Eq. 7.3.23). The heat capacity at constant volume is $C_V = dU/dT$. The slope r in general is then given by

$$r = \frac{dT}{dt} = \frac{dT}{dU} \frac{dU}{dt} = -(k/\epsilon)(T - T_\infty) \quad (7.3.29)$$

Applying this relation to the points at times t_1 and t_2 , we have the following simultaneous equations in the unknowns k/ϵ and T_∞ :

$$r_1 = -(k/\epsilon)(T_1 - T_\infty) \quad r_2 = -(k/\epsilon)(T_2 - T_\infty) \quad (7.3.30)$$

The solutions are

$$(k/\epsilon) = \frac{r_1 - r_2}{T_2 - T_1} \quad T_\infty = \frac{r_1 T_2 - r_2 T_1}{r_1 - r_2} \quad (7.3.31)$$

Finally, k is given by

$$k = (k/\epsilon)\epsilon = \left(\frac{r_1 - r_2}{T_2 - T_1} \right) \epsilon \quad (7.3.32)$$

When the *pressure* is constant, this procedure yields the same relations for k/ϵ , T_∞ , and k .

Continuous-flow calorimeters

A flow calorimeter is a third type of calorimeter used to measure the heat capacity of a fluid phase. The gas or liquid flows through a tube at a known constant rate past an electrical heater of known constant power input. After a steady state has been achieved in the tube, the temperature increase ΔT at the heater is measured.

If \dot{w}_{el}/dt is the rate at which electrical work is performed (the electric power) and dm/dt is the mass flow rate, then in time interval Δt a quantity $w = (\dot{w}_{\text{el}}/dt)\Delta t$ of work is performed on an amount $n = (dm/dt)\Delta t/M$ of the fluid (where M is the molar mass). If heat flow is negligible, the molar heat capacity of the substance is given by

$$C_{p,m} = \frac{w}{n\Delta T} = \frac{M(\dot{w}_{\text{el}}/dt)}{\Delta T(dm/dt)} \quad (7.3.33)$$

To correct for the effects of heat flow, ΔT is usually measured over a range of flow rates and the results extrapolated to infinite flow rate.

7.3.3 Typical values

Figure 7.5 on the next page shows the temperature dependence of $C_{p,m}$ for several substances. The discontinuities seen at certain temperatures occur at equilibrium phase transitions. At these temperatures the heat capacity is in effect infinite, since the phase transition of a pure substance involves finite heat with zero temperature change.

7.4 Heating at Constant Volume or Pressure

Consider the process of changing the temperature of a phase at constant volume.⁶ The rate of change of internal energy with T under these conditions is the heat capacity at constant

⁶Keeping the volume exactly constant while increasing the temperature is not as simple as it may sound. Most solids expand when heated, unless we arrange to increase the external pressure at the same time. If we use solid walls to contain a fluid phase, the container volume will change with temperature. For practical purposes, these volume changes are usually negligible.

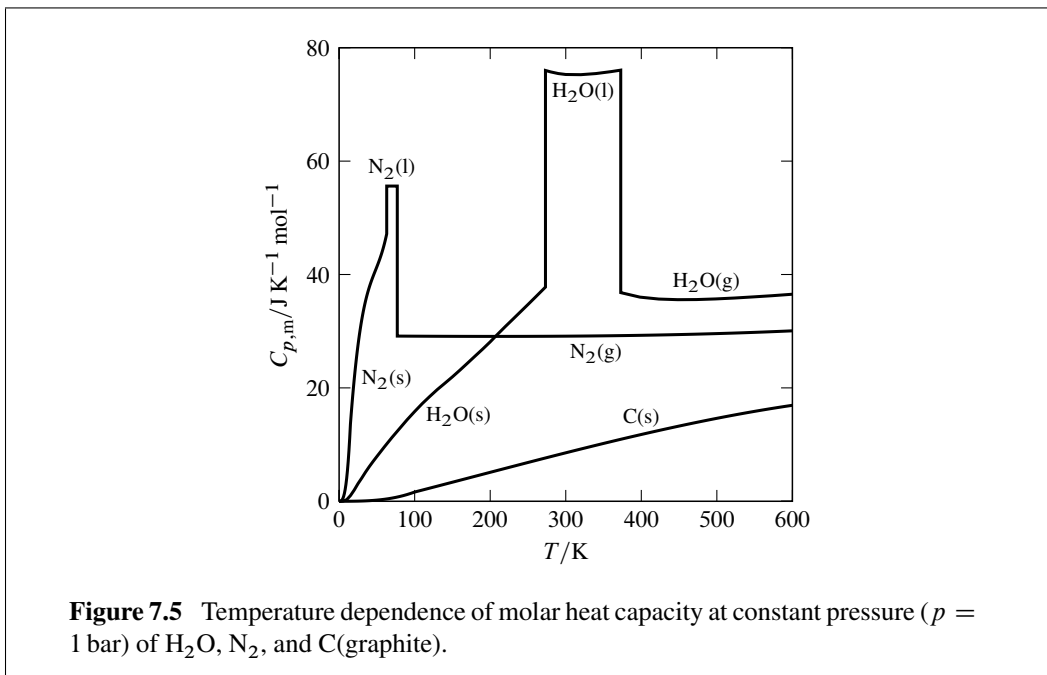

volume: $C_V = (\partial U/\partial T)_V$ (Eq. 7.3.1). Accordingly, an infinitesimal change of U is given by

$$dU = C_V dT \quad (7.4.1)$$

(closed system,
 $C=1, P=1, \text{ constant } V$)

and the finite change of U between temperatures T_1 and T_2 is

$$\Delta U = \int_{T_1}^{T_2} C_V dT \quad (7.4.2)$$

(closed system,
 $C=1, P=1, \text{ constant } V$)

Three comments, relevant to these and other equations in this chapter, are in order:

1. Equation 7.4.2 allows us to calculate the finite change of a state function, U , by integrating C_V over T . The equation was derived under the condition that V is constant during the process, and the use of the integration variable T implies that the system has a single, uniform temperature at each instant during the process. The integrand C_V may depend on both V and T , and we should integrate with V held constant and C_V treated as a function only of T .
2. Suppose we want to evaluate ΔU for a process in which the volume is the same in the initial and final states ($V_2 = V_1$) but is different in some intermediate states, and the temperature is *not* uniform in some of the intermediate states. We know the change of a state function depends only on the initial and final states, so we can still use Eq. 7.4.2 to evaluate ΔU for this process. We integrate with V held constant, although V was not constant during the actual process.

In general: A finite change ΔX of a state function, evaluated under the condition that another state function Y is constant, is the same as ΔX under the less stringent condition $Y_2 = Y_1$. (Another application of this principle was mentioned in Sec. 4.6.2.)

3. For a pure substance, we may convert an expression for an infinitesimal or finite change of an extensive property to an expression for the change of the corresponding *molar* property by dividing by n . For instance, Eq. 7.4.1 becomes

$$dU_m = C_{V,m} dT \quad (7.4.3)$$

and Eq. 7.4.2 becomes

$$\Delta U_m = \int_{T_1}^{T_2} C_{V,m} dT \quad (7.4.4)$$

If, at a fixed volume and over the temperature range T_1 to T_2 , the value of C_V is essentially constant (i.e., independent of T), Eq. 7.4.2 becomes

$$\Delta U = C_V(T_2 - T_1) \quad (7.4.5)$$

(closed system, $C=1$,
 $P=1$, constant V and C_V)

An infinitesimal entropy change during a reversible process in a closed system is given according to the second law by $dS = \delta q/T$. At constant volume, δq is equal to dU which in turn equals $C_V dT$. Therefore, the entropy change is

$$dS = \frac{C_V}{T} dT \quad (7.4.6)$$

(closed system,
 $C=1$, $P=1$, constant V)

Integration yields the finite change

$$\Delta S = \int_{T_1}^{T_2} \frac{C_V}{T} dT \quad (7.4.7)$$

(closed system,
 $C=1$, $P=1$, constant V)

If C_V is treated as constant, Eq. 7.4.7 becomes

$$\Delta S = C_V \ln \frac{T_2}{T_1} \quad (7.4.8)$$

(closed system, $C=1$,
 $P=1$, constant V and C_V)

(More general versions of the two preceding equations have already been given in Sec. 4.6.1.)

Since C_V is positive, we see from Eqs. 7.4.2 and 7.4.7 that heating a phase at constant volume causes both U and S to increase.

We may derive relations for a temperature change at constant *pressure* by the same methods. From $C_p = (\partial H/\partial T)_p$ (Eq. 7.3.2), we obtain

$$\Delta H = \int_{T_1}^{T_2} C_p dT \quad (7.4.9)$$

(closed system,
 $C=1, P=1, \text{ constant } p$)

If C_p is treated as constant, Eq. 7.4.9 becomes

$$\Delta H = C_p(T_2 - T_1) \quad (7.4.10)$$

(closed system, $C=1,$
 $P=1, \text{ constant } p \text{ and } C_p$)

From $dS = \delta q/T$ and Eq. 7.3.2 we obtain for the entropy change at constant pressure

$$dS = \frac{C_p}{T} dT \quad (7.4.11)$$

(closed system,
 $C=1, P=1, \text{ constant } p$)

Integration gives

$$\Delta S = \int_{T_1}^{T_2} \frac{C_p}{T} dT \quad (7.4.12)$$

(closed system,
 $C=1, P=1, \text{ constant } p$)

or, with C_p treated as constant,

$$\Delta S = C_p \ln \frac{T_2}{T_1} \quad (7.4.13)$$

(closed system, $C=1,$
 $P=1, \text{ constant } p \text{ and } C_p$)

C_p is positive, so heating a phase at constant pressure causes H and S to increase.

The Gibbs energy changes according to $(\partial G/\partial T)_p = -S$ (Eq. 5.4.11), so heating at constant pressure causes G to decrease.

7.5 Partial Derivatives with Respect to T , p , and V

7.5.1 Tables of partial derivatives

The tables in this section collect useful expressions for partial derivatives of the eight state functions T , p , V , U , H , A , G , and S in a closed, single-phase system. Each derivative is taken with respect to one of the three easily-controlled variables T , p , or V while another of these variables is held constant. We have already seen some of these expressions, and the derivations of the others are indicated below.

We can use these partial derivatives (1) for writing an expression for the total differential of any of the eight quantities, and (2) for expressing the finite change in one of these

Table 7.1 *Constant temperature:* expressions for partial derivatives of state functions with respect to pressure and volume in a closed, single-phase system

Partial derivative	General expression	Ideal gas	Partial derivative	General expression	Ideal gas
$\left(\frac{\partial p}{\partial V}\right)_T$	$-\frac{1}{\kappa_T V}$	$-\frac{p}{V}$	$\left(\frac{\partial A}{\partial p}\right)_T$	$\kappa_T pV$	V
$\left(\frac{\partial V}{\partial p}\right)_T$	$-\kappa_T V$	$-\frac{V}{p}$	$\left(\frac{\partial A}{\partial V}\right)_T$	$-p$	$-p$
$\left(\frac{\partial U}{\partial p}\right)_T$	$(-\alpha T + \kappa_T p)V$	0	$\left(\frac{\partial G}{\partial p}\right)_T$	V	V
$\left(\frac{\partial U}{\partial V}\right)_T$	$\frac{\alpha T}{\kappa_T} - p$	0	$\left(\frac{\partial G}{\partial V}\right)_T$	$-\frac{1}{\kappa_T}$	$-p$
$\left(\frac{\partial H}{\partial p}\right)_T$	$(1 - \alpha T)V$	0	$\left(\frac{\partial S}{\partial p}\right)_T$	$-\alpha V$	$-\frac{V}{T}$
$\left(\frac{\partial H}{\partial V}\right)_T$	$\frac{\alpha T - 1}{\kappa_T}$	0	$\left(\frac{\partial S}{\partial V}\right)_T$	$\frac{\alpha}{\kappa_T}$	$\frac{p}{T}$

quantities as an integral under conditions of constant T , p , or V . For instance, given the expressions

$$\left(\frac{\partial S}{\partial T}\right)_p = \frac{C_p}{T} \quad \text{and} \quad \left(\frac{\partial S}{\partial p}\right)_T = -\alpha V \quad (7.5.1)$$

we may write the total differential of S , taking T and p as the independent variables, as

$$dS = \frac{C_p}{T} dT - \alpha V dp \quad (7.5.2)$$

Furthermore, the first expression is equivalent to the differential form

$$dS = \frac{C_p}{T} dT \quad (7.5.3)$$

provided p is constant; we can integrate this equation to obtain the finite change ΔS under isobaric conditions as shown in Eq. 7.4.12.

Both general expressions and expressions valid for an ideal gas are given in Tables 7.1, 7.2, and 7.3.

We may derive the general expressions as follows. We are considering differentiation with respect only to T , p , and V . Expressions for $(\partial V/\partial T)_p$, $(\partial V/\partial p)_T$, and $(\partial p/\partial T)_V$ come from Eqs. 7.1.1, 7.1.2, and 7.1.7 and are shown as functions of α and κ_T . The reciprocal of each of these three expressions provides the expression for another partial derivative from the general relation

$$(\partial y/\partial x)_z = \frac{1}{(\partial x/\partial y)_z} \quad (7.5.4)$$

This procedure gives us expressions for the six partial derivatives of T , p , and V .

The remaining expressions are for partial derivatives of U , H , A , G , and S . We obtain the expression for $(\partial U/\partial T)_V$ from Eq. 7.3.1, for $(\partial U/\partial V)_T$ from Eq. 7.2.4,

Table 7.2 *Constant pressure*: expressions for partial derivatives of state functions with respect to temperature and volume in a closed, single-phase system

Partial derivative	General expression	Ideal gas	Partial derivative	General expression	Ideal gas
$\left(\frac{\partial T}{\partial V}\right)_p$	$\frac{1}{\alpha V}$	$\frac{T}{V}$	$\left(\frac{\partial A}{\partial T}\right)_p$	$-\alpha pV - S$	$-\frac{pV}{T} - S$
$\left(\frac{\partial V}{\partial T}\right)_p$	αV	$\frac{V}{T}$	$\left(\frac{\partial A}{\partial V}\right)_p$	$-p - \frac{S}{\alpha V}$	$-p - \frac{TS}{V}$
$\left(\frac{\partial U}{\partial T}\right)_p$	$C_p - \alpha pV$	C_V	$\left(\frac{\partial G}{\partial T}\right)_p$	$-S$	$-S$
$\left(\frac{\partial U}{\partial V}\right)_p$	$\frac{C_p}{\alpha V} - p$	$\frac{C_V T}{V}$	$\left(\frac{\partial G}{\partial V}\right)_p$	$-\frac{S}{\alpha V}$	$-\frac{TS}{V}$
$\left(\frac{\partial H}{\partial T}\right)_p$	C_p	C_p	$\left(\frac{\partial S}{\partial T}\right)_p$	$\frac{C_p}{T}$	$\frac{C_p}{T}$
$\left(\frac{\partial H}{\partial V}\right)_p$	$\frac{C_p}{\alpha V}$	$\frac{C_p T}{V}$	$\left(\frac{\partial S}{\partial V}\right)_p$	$\frac{C_p}{\alpha T V}$	$\frac{C_p}{V}$

Table 7.3 *Constant volume*: expressions for partial derivatives of state functions with respect to temperature and pressure in a closed, single-phase system

Partial derivative	General expression	Ideal gas	Partial derivative	General expression	Ideal gas
$\left(\frac{\partial T}{\partial p}\right)_V$	$\frac{\kappa_T}{\alpha}$	$\frac{T}{p}$	$\left(\frac{\partial A}{\partial T}\right)_V$	$-S$	$-S$
$\left(\frac{\partial p}{\partial T}\right)_V$	$\frac{\alpha}{\kappa_T}$	$\frac{p}{T}$	$\left(\frac{\partial A}{\partial p}\right)_V$	$-\frac{\kappa_T S}{\alpha}$	$-\frac{TS}{p}$
$\left(\frac{\partial U}{\partial T}\right)_V$	C_V	C_V	$\left(\frac{\partial G}{\partial T}\right)_V$	$\frac{\alpha V}{\kappa_T} - S$	$\frac{pV}{T} - S$
$\left(\frac{\partial U}{\partial p}\right)_V$	$\frac{\kappa_T C_p}{\alpha} - \alpha T V$	$\frac{T C_V}{p}$	$\left(\frac{\partial G}{\partial p}\right)_V$	$V - \frac{\kappa_T S}{\alpha}$	$V - \frac{TS}{p}$
$\left(\frac{\partial H}{\partial T}\right)_V$	$C_p + \frac{\alpha V}{\kappa_T} (1 - \alpha T)$	C_p	$\left(\frac{\partial S}{\partial T}\right)_V$	$\frac{C_V}{T}$	$\frac{C_V}{T}$
$\left(\frac{\partial H}{\partial p}\right)_V$	$\frac{\kappa_T C_p}{\alpha} + V(1 - \alpha T)$	$\frac{C_p T}{p}$	$\left(\frac{\partial S}{\partial p}\right)_V$	$\frac{\kappa_T C_p}{\alpha T} - \alpha V$	$\frac{C_V}{p}$

for $(\partial H/\partial T)_p$ from Eq. 7.3.2, for $(\partial A/\partial T)_V$ from Eq. 5.4.9, for $(\partial A/\partial V)_T$ from Eq. 5.4.10, for $(\partial G/\partial p)_T$ from Eq. 5.4.12, for $(\partial G/\partial T)_p$ from Eq. 5.4.11, for $(\partial S/\partial T)_V$ from Eq. 7.4.6, for $(\partial S/\partial T)_p$ from Eq. 7.4.11, and for $(\partial S/\partial p)_T$ from Eq. 5.4.18.

We can transform each of these partial derivatives, and others derived in later steps, to two other partial derivatives with the same variable held constant and the variable of differentiation changed. The transformation involves multiplying by an appropriate partial derivative of T , p , or V . For instance, from the partial derivative $(\partial U/\partial V)_T = (\alpha T/\kappa_T) - p$, we obtain

$$\left(\frac{\partial U}{\partial p}\right)_T = \left(\frac{\partial U}{\partial V}\right)_T \left(\frac{\partial V}{\partial p}\right)_T = \left(\frac{\alpha T}{\kappa_T} - p\right) (-\kappa_T V) = (-\alpha T + \kappa_T p) V \quad (7.5.5)$$

The remaining partial derivatives can be found by differentiating $U = H - pV$, $H = U + pV$, $A = U - TS$, and $G = H - TS$ and making appropriate substitutions. Whenever a partial derivative appears in a derived expression, it is replaced with an expression derived in an earlier step. The expressions derived by these steps constitute the full set shown in Tables 7.1, 7.2, and 7.3.

Bridgman⁷ devised a simple method to obtain expressions for these and many other partial derivatives from a relatively small set of formulas.

7.5.2 The Joule–Thomson coefficient

The Joule–Thomson coefficient of a gas was defined in Eq. 6.3.3 on page 161 by $\mu_{JT} = (\partial T / \partial p)_H$. It can be evaluated with measurements of T and p during adiabatic throttling processes as described in Sec. 6.3.1.

To relate μ_{JT} to other properties of the gas, we write the total differential of the enthalpy of a closed, single-phase system in the form

$$dH = \left(\frac{\partial H}{\partial T} \right)_p dT + \left(\frac{\partial H}{\partial p} \right)_T dp \quad (7.5.6)$$

and divide both sides by dp :

$$\frac{dH}{dp} = \left(\frac{\partial H}{\partial T} \right)_p \frac{dT}{dp} + \left(\frac{\partial H}{\partial p} \right)_T \quad (7.5.7)$$

Next we impose a condition of constant H ; the ratio dT / dp becomes a partial derivative:

$$0 = \left(\frac{\partial H}{\partial T} \right)_p \left(\frac{\partial T}{\partial p} \right)_H + \left(\frac{\partial H}{\partial p} \right)_T \quad (7.5.8)$$

Rearrangement gives

$$\left(\frac{\partial T}{\partial p} \right)_H = - \frac{(\partial H / \partial p)_T}{(\partial H / \partial T)_p} \quad (7.5.9)$$

The left side of this equation is the Joule–Thomson coefficient. An expression for the partial derivative $(\partial H / \partial p)_T$ is given in Table 7.1, and the partial derivative $(\partial H / \partial T)_p$ is the heat capacity at constant pressure (Eq. 5.6.3). These substitutions give us the desired relation

$$\mu_{JT} = \frac{(\alpha T - 1)V}{C_p} = \frac{(\alpha T - 1)V_m}{C_{p,m}} \quad (7.5.10)$$

7.6 Isothermal Pressure Changes

In various applications, we will need expressions for the effect of changing the pressure at constant temperature on the internal energy, enthalpy, entropy, and Gibbs energy of a phase. We obtain the expressions by integrating expressions found in Table 7.1. For example, ΔU is given by $\int (\partial U / \partial p)_T dp$. The results are listed in the second column of Table 7.4 on the next page.

⁷Ref. [22]; Ref. [21], p. 199–241.

Table 7.4 Changes of state functions during an isothermal pressure change in a closed, single-phase system

State function change	General expression	Ideal gas	Approximate expression for liquid or solid
ΔU	$\int_{p_1}^{p_2} (-\alpha T + \kappa_T p) V dp$	0	$-\alpha T V \Delta p$
ΔH	$\int_{p_1}^{p_2} (1 - \alpha T) V dp$	0	$(1 - \alpha T) V \Delta p$
ΔA	$\int_{p_1}^{p_2} \kappa_T p V dp$	$nRT \ln \frac{p_2}{p_1}$	$\kappa_T V (p_2^2 - p_1^2)/2$
ΔG	$\int_{p_1}^{p_2} V dp$	$nRT \ln \frac{p_2}{p_1}$	$V \Delta p$
ΔS	$-\int_{p_1}^{p_2} \alpha V dp$	$-nR \ln \frac{p_2}{p_1}$	$-\alpha V \Delta p$

7.6.1 Ideal gases

Simplifications result when the phase is an ideal gas. In this case, we can make the substitutions $V = nRT/p$, $\alpha = 1/T$, and $\kappa_T = 1/p$, resulting in the expressions in the third column of Table 7.4.

The expressions in the third column of Table 7.4 may be summarized by the statement that, when an ideal gas expands isothermally, the internal energy and enthalpy stay constant, the entropy increases, and the Helmholtz energy and Gibbs energy decrease.

7.6.2 Condensed phases

Solids, and liquids under conditions of temperature and pressure not close to the critical point, are much less compressible than gases. Typically the isothermal compressibility, κ_T , of a liquid or solid at room temperature and atmospheric pressure is no greater than $1 \times 10^{-4} \text{ bar}^{-1}$ (see Fig. 7.2 on page 168), whereas an ideal gas under these conditions has $\kappa_T = 1/p = 1 \text{ bar}^{-1}$. Consequently, it is frequently valid to treat V for a liquid or solid as essentially constant during a pressure change at constant temperature. Because κ_T is small, the product $\kappa_T p$ for a liquid or solid is usually much smaller than the product αT . Furthermore, κ_T for liquids and solids does not change rapidly with p as it does for gases, and neither does α .

With the approximations that V , α , and κ_T are constant during an isothermal pressure change, and that $\kappa_T p$ is negligible compared with αT , we obtain the expressions in the last column of Table 7.4.

7.7 Standard States of Pure Substances

It is often useful to refer to a reference pressure, the **standard pressure**, denoted p° . The standard pressure has an arbitrary but constant value in any given application. Until 1982, chemists used a standard pressure of 1 atm ($1.01325 \times 10^5 \text{ Pa}$). The IUPAC now recom-

mends the value $p^\circ = 1 \text{ bar}$ (exactly 10^5 Pa). This book uses the latter value unless stated otherwise. (Note that there is no defined standard *temperature*.)

A superscript degree symbol ($^\circ$) denotes a standard quantity or standard-state conditions. An alternative symbol for this purpose, used extensively outside the U.S., is a superscript Plimsoll mark (\ominus).⁸

A **standard state** of a pure substance is a particular reference state appropriate for the kind of phase and is described by intensive variables. This book follows the recommendations of the IUPAC Green Book⁹ for various standard states.

- The standard state of a *pure gas* is the hypothetical state in which the gas is at pressure p° and the temperature of interest, and the gas behaves as an ideal gas. The molar volume of a gas at 1 bar may have a measurable deviation from the molar volume predicted by the ideal gas equation due to intermolecular forces. We must imagine the standard state in this case to consist of the gas with the intermolecular forces magically “turned off” and the molar volume adjusted to the ideal-gas value RT/p° .
- The standard state of a *pure liquid or solid* is the unstressed liquid or solid at pressure p° and the temperature of interest. If the liquid or solid is stable under these conditions, this is a real (not hypothetical) state.

Section 9.7 will introduce additional standard states for constituents of mixtures.

7.8 Chemical Potential and Fugacity

The **chemical potential**, μ , of a pure substance has as one of its definitions (page 145)

$$\mu \stackrel{\text{def}}{=} G_{\text{m}} = \frac{G}{n} \quad (7.8.1)$$

(pure substance)

That is, μ is equal to the molar Gibbs energy of the substance at a given temperature and pressure. (Section 9.2.6 will introduce a more general definition of chemical potential that applies also to a constituent of a mixture.) The chemical potential is an intensive state function.

The total differential of the Gibbs energy of a fixed amount of a pure substance in a single phase, with T and p as independent variables, is $dG = -S dT + V dp$ (Eq. 5.4.4). Dividing both sides of this equation by n gives the total differential of the chemical potential with these same independent variables:

$$d\mu = -S_{\text{m}} dT + V_{\text{m}} dp \quad (7.8.2)$$

(pure substance, $P=1$)

(Since all quantities in this equation are intensive, it is not necessary to specify a closed system; the amount of the substance in the system is irrelevant.)

⁸The Plimsoll mark is named after the British merchant Samuel Plimsoll, at whose instigation Parliament passed an act in 1875 requiring the symbol to be placed on the hulls of cargo ships to indicate the maximum depth for safe loading.

⁹Ref. [36], p. 61–62.

We identify the coefficients of the terms on the right side of Eq. 7.8.2 as the partial derivatives

$$\left(\frac{\partial\mu}{\partial T}\right)_P = -S_m \quad (7.8.3)$$

(pure substance, $P=1$)

and

$$\left(\frac{\partial\mu}{\partial p}\right)_T = V_m \quad (7.8.4)$$

(pure substance, $P=1$)

Since V_m is positive, Eq. 7.8.4 shows that the chemical potential increases with increasing pressure in an isothermal process.

The **standard chemical potential**, μ° , of a pure substance in a given phase and at a given temperature is the chemical potential of the substance when it is in the standard state of the phase at this temperature and the standard pressure p° .

There is no way we can evaluate the absolute value of μ at a given temperature and pressure, or of μ° at the same temperature,¹⁰ but we can measure or calculate the *difference* $\mu - \mu^\circ$. The general procedure is to integrate $d\mu = V_m dp$ (Eq. 7.8.2 with dT set equal to zero) from the standard state at pressure p° to the experimental state at pressure p' :

$$\mu(p') - \mu^\circ = \int_{p^\circ}^{p'} V_m dp \quad (7.8.5)$$

(constant T)

7.8.1 Gases

For the standard chemical potential of a gas, this book will usually use the notation $\mu^\circ(\text{g})$ to emphasize the choice of a *gas* standard state.

An *ideal gas* is in its standard state at a given temperature when its pressure is the standard pressure. We find the relation of the chemical potential of an ideal gas to its pressure and its standard chemical potential at the same temperature by setting V_m equal to RT/p in Eq. 7.8.5: $\mu(p') - \mu^\circ = \int_{p^\circ}^{p'} (RT/p) dp = RT \ln(p'/p^\circ)$. The general relation for μ as a function of p , then, is

$$\mu = \mu^\circ(\text{g}) + RT \ln \frac{p}{p^\circ} \quad (7.8.6)$$

(pure ideal gas, constant T)

This function is shown as the dashed curve in Fig. 7.6 on the next page.

If a gas is *not* an ideal gas, its standard state is a hypothetical state. The **fugacity**, f , of a real gas (a gas that is not necessarily an ideal gas) is defined by an equation with the same form as Eq. 7.8.6:

$$\mu = \mu^\circ(\text{g}) + RT \ln \frac{f}{p^\circ} \quad (7.8.7)$$

(pure gas)

¹⁰At least not to any useful degree of precision. The values of μ and μ° include the molar internal energy whose absolute value can only be calculated from the Einstein relation; see Sec. 2.6.2.

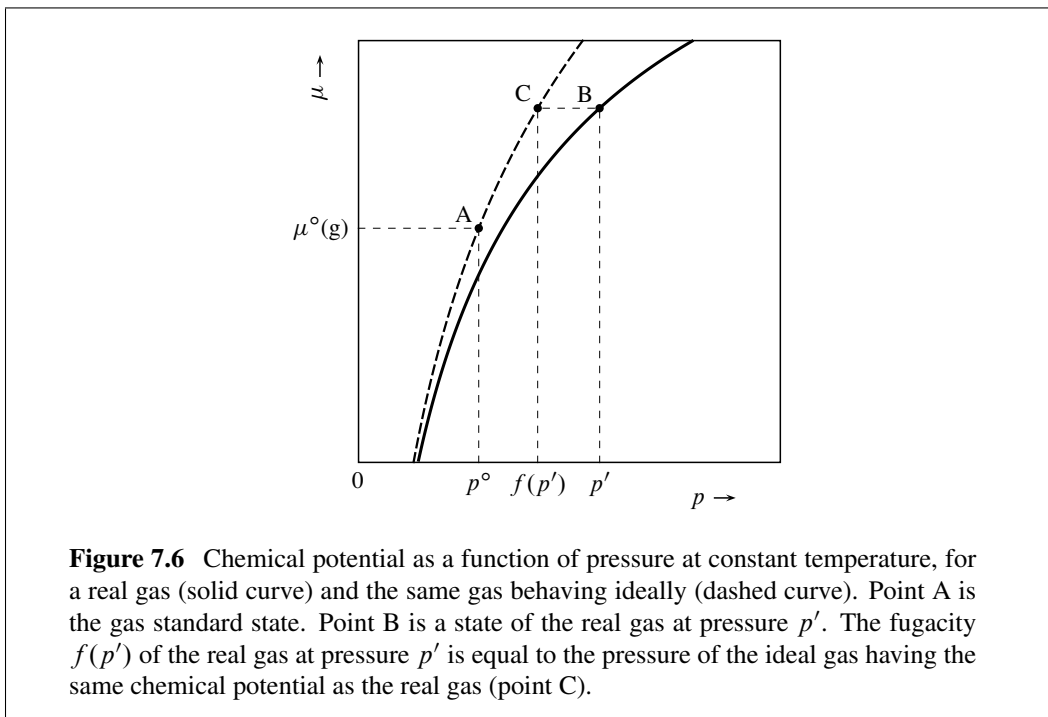

or

$$f \stackrel{\text{def}}{=} p^\circ \exp \left[\frac{\mu - \mu^\circ(\text{g})}{RT} \right] \quad (7.8.8)$$

(pure gas)

Note that fugacity has the dimensions of pressure. Fugacity is a kind of effective pressure. Specifically, it is the pressure that the hypothetical ideal gas (the gas with intermolecular forces “turned off”) would need to have in order for its chemical potential at the given temperature to be the same as the chemical potential of the real gas (see point C in Fig. 7.6). If the gas is an ideal gas, its fugacity is equal to its pressure.

To evaluate the fugacity of a real gas at a given T and p , we must relate the chemical potential to the pressure–volume behavior. Let μ' be the chemical potential and f' be the fugacity at the pressure p' of interest; let μ'' be the chemical potential and f'' be the fugacity of the same gas at some low pressure p'' (all at the same temperature). Then we use Eq. 7.8.5 to write $\mu' - \mu^\circ(\text{g}) = RT \ln(f'/p^\circ)$ and $\mu'' - \mu^\circ(\text{g}) = RT \ln(f''/p^\circ)$, from which we obtain

$$\mu' - \mu'' = RT \ln \frac{f'}{f''} \quad (7.8.9)$$

By integrating $d\mu = V_m dp$ from pressure p'' to pressure p' , we obtain

$$\mu' - \mu'' = \int_{\mu''}^{\mu'} d\mu = \int_{p''}^{p'} V_m dp \quad (7.8.10)$$

Equating the two expressions for $\mu' - \mu''$ and dividing by RT gives

$$\ln \frac{f'}{f''} = \int_{p''}^{p'} \frac{V_m}{RT} dp \quad (7.8.11)$$

In principle, we could use the integral on the right side of Eq. 7.8.11 to evaluate f' by choosing the lower integration limit p'' to be such a low pressure that the gas behaves as an ideal gas and replacing f'' by p'' . However, because the integrand V_m/RT becomes very large at low pressure, the integral is difficult to evaluate. We avoid this difficulty by subtracting from the preceding equation the identity

$$\ln \frac{p'}{p''} = \int_{p''}^{p'} \frac{dp}{p} \quad (7.8.12)$$

which is simply the result of integrating the function $1/p$ from p'' to p' . The result is

$$\ln \frac{f' p''}{f'' p'} = \int_{p''}^{p'} \left(\frac{V_m}{RT} - \frac{1}{p} \right) dp \quad (7.8.13)$$

Now we take the limit of both sides of Eq. 7.8.13 as p'' approaches zero. In this limit, the gas at pressure p'' approaches ideal-gas behavior, f'' approaches p'' , and the ratio $f' p''/f'' p'$ approaches f'/p' :

$$\ln \frac{f'}{p'} = \int_0^{p'} \left(\frac{V_m}{RT} - \frac{1}{p} \right) dp \quad (7.8.14)$$

The integrand $(V_m/RT - 1/p)$ of this integral approaches zero at low pressure, making it feasible to evaluate the integral from experimental data.

The **fugacity coefficient** ϕ of a gas is defined by

$$\phi \stackrel{\text{def}}{=} \frac{f}{p} \quad \text{or} \quad f = \phi p \quad (7.8.15)$$

(pure gas)

The fugacity coefficient at pressure p' is then given by Eq. 7.8.14:

$$\ln \phi(p') = \int_0^{p'} \left(\frac{V_m}{RT} - \frac{1}{p} \right) dp \quad (7.8.16)$$

(pure gas, constant T)

The isothermal behavior of real gases at low to moderate pressures (up to at least 1 bar) is usually adequately described by a two-term equation of state of the form given in Eq. 2.2.8:

$$V_m \approx \frac{RT}{p} + B \quad (7.8.17)$$

Here B is the second virial coefficient, a function of T . With this equation of state, Eq. 7.8.16 becomes

$$\ln \phi \approx \frac{Bp}{RT} \quad (7.8.18)$$

For a real gas at temperature T and pressure p , Eq. 7.8.16 or 7.8.18 allows us to evaluate the fugacity coefficient from an experimental equation of state or a second virial coefficient. We can then find the fugacity from $f = \phi p$.

As we will see in Sec. 9.7, the dimensionless ratio $\phi = f/p$ is an example of an *activity coefficient* and the dimensionless ratio f/p° is an example of an *activity*.

7.8.2 Liquids and solids

The dependence of the chemical potential on pressure at constant temperature is given by Eq. 7.8.5. With an approximation of zero compressibility, this becomes

$$\mu \approx \mu^\circ + V_m(p - p^\circ) \quad (7.8.19)$$

(pure liquid or solid,
constant T)

7.9 Standard Molar Quantities of a Gas

A **standard molar quantity** of a substance is the molar quantity in the standard state at the temperature of interest. We have seen (Sec. 7.7) that the standard state of a pure *liquid* or *solid* is a real state, so any standard molar quantity of a pure liquid or solid is simply the molar quantity evaluated at the standard pressure and the temperature of interest.

The standard state of a *gas*, however, is a hypothetical state in which the gas behaves ideally at the standard pressure without influence of intermolecular forces. The properties of the gas in this standard state are those of an ideal gas. We would like to be able to relate molar properties of the real gas at a given temperature and pressure to the molar properties in the standard state at the same temperature.

We begin by using Eq. 7.8.7 to write an expression for the chemical potential of the real gas at pressure p' :

$$\begin{aligned} \mu(p') &= \mu^\circ(\text{g}) + RT \ln \frac{f(p')}{p^\circ} \\ &= \mu^\circ(\text{g}) + RT \ln \frac{p'}{p^\circ} + RT \ln \frac{f(p')}{p'} \end{aligned} \quad (7.9.1)$$

We then substitute from Eq. 7.8.14 to obtain a relation between the chemical potential, the standard chemical potential, and measurable properties, all at the same temperature:

$$\mu(p') = \mu^\circ(\text{g}) + RT \ln \frac{p'}{p^\circ} + \int_0^{p'} \left(V_m - \frac{RT}{p} \right) dp \quad (7.9.2)$$

(pure gas)

Note that this expression for μ is not what we would obtain by simply integrating $d\mu = V_m dp$ from p° to p' , because the real gas is not necessarily in its standard state of ideal-gas behavior at a pressure of 1 bar.

Recall that the chemical potential μ of a pure substance is also its molar Gibbs energy $G_m = G/n$. The standard chemical potential $\mu^\circ(\text{g})$ of the gas is the standard molar Gibbs energy, $G_m^\circ(\text{g})$. Therefore Eq. 7.9.2 can be rewritten in the form

$$G_m(p') = G_m^\circ(\text{g}) + RT \ln \frac{p'}{p^\circ} + \int_0^{p'} \left(V_m - \frac{RT}{p} \right) dp \quad (7.9.3)$$

The middle column of Table 7.5 on the next page contains an expression for $G_m(p') - G_m^\circ(\text{g})$ taken from this equation. This expression contains all the information needed to find a relation between any other molar property and its standard molar value in terms of measurable properties. The way this can be done is as follows.

Table 7.5 Real gases: expressions for differences between molar properties and standard molar values at the same temperature

Difference	General expression at pressure p'	Equation of state $V = nRT/p + nB$
$U_m - U_m^\circ(\text{g})$	$\int_0^{p'} \left[V_m - T \left(\frac{\partial V_m}{\partial T} \right)_p \right] dp + RT - p'V_m$	$-pT \frac{dB}{dT}$
$H_m - H_m^\circ(\text{g})$	$\int_0^{p'} \left[V_m - T \left(\frac{\partial V_m}{\partial T} \right)_p \right] dp$	$p \left(B - T \frac{dB}{dT} \right)$
$A_m - A_m^\circ(\text{g})$	$RT \ln \frac{p'}{p^\circ} + \int_0^{p'} \left(V_m - \frac{RT}{p} \right) dp + RT - p'V_m$	$RT \ln \frac{p}{p^\circ}$
$G_m - G_m^\circ(\text{g})$	$RT \ln \frac{p'}{p^\circ} + \int_0^{p'} \left(V_m - \frac{RT}{p} \right) dp$	$RT \ln \frac{p}{p^\circ} + Bp$
$S_m - S_m^\circ(\text{g})$	$-R \ln \frac{p'}{p^\circ} - \int_0^{p'} \left[\left(\frac{\partial V_m}{\partial T} \right)_p - \frac{R}{p} \right] dp$	$-R \ln \frac{p}{p^\circ} - p \frac{dB}{dT}$
$C_{p,m} - C_{p,m}^\circ(\text{g})$	$-\int_0^{p'} T \left(\frac{\partial^2 V_m}{\partial T^2} \right)_p dp$	$-pT \frac{d^2B}{dT^2}$

The relation between the chemical potential of a pure substance and its molar entropy is given by Eq. 7.8.3:

$$S_m = - \left(\frac{\partial \mu}{\partial T} \right)_p \quad (7.9.4)$$

The standard molar entropy of the gas is found from Eq. 7.9.4 by changing μ to $\mu^\circ(\text{g})$:

$$S_m^\circ(\text{g}) = - \left(\frac{\partial \mu^\circ(\text{g})}{\partial T} \right)_p \quad (7.9.5)$$

By substituting the expression for μ given by Eq. 7.9.2 into Eq. 7.9.4 and comparing the result with Eq. 7.9.5, we obtain

$$S_m(p') = S_m^\circ(\text{g}) - R \ln \frac{p'}{p^\circ} - \int_0^{p'} \left[\left(\frac{\partial V_m}{\partial T} \right)_p - \frac{R}{p} \right] dp \quad (7.9.6)$$

The expression for $S_m - S_m^\circ(\text{g})$ in the middle column of Table 7.5 comes from this equation. The equation, together with a value of S_m for a real gas obtained by the calorimetric method described in Sec. 6.2.1, can be used to evaluate $S_m^\circ(\text{g})$.

Now we can use the expressions for G_m and S_m to find expressions for molar quantities such as H_m and $C_{p,m}$ relative to the respective standard molar quantities. The general procedure for a molar quantity X_m is to write an expression for X_m as a function of G_m and S_m and an analogous expression for $X_m^\circ(\text{g})$ as a function of $G_m^\circ(\text{g})$ and $S_m^\circ(\text{g})$. Substitutions for G_m and S_m from Eqs. 7.9.3 and 7.9.6 are then made in the expression for X_m , and the difference $X_m - X_m^\circ(\text{g})$ taken.

For example, the expression for $U_m - U_m^\circ(\text{g})$ in the middle column Table 7.5 was derived as follows. The equation defining the Gibbs energy, $G = U - TS + pV$, was divided by the amount n and rearranged to

$$U_m = G_m + TS_m - pV_m \quad (7.9.7)$$

The standard-state version of this relation is

$$U_m^\circ(\text{g}) = G_m^\circ(\text{g}) + TS_m^\circ(\text{g}) - p^\circ V_m^\circ(\text{g}) \quad (7.9.8)$$

where from the ideal gas law $p^\circ V_m^\circ(\text{g})$ can be replaced by RT . Substitutions from Eqs. 7.9.3 and 7.9.6 were made in Eq. 7.9.7 and the expression for $U_m^\circ(\text{g})$ in Eq. 7.9.8 was subtracted, resulting in the expression in the table.

For a real gas at low to moderate pressures, we can approximate V_m by $(RT/p) + B$ where B is the second virial coefficient (Eq. 7.8.17). Equation 7.9.2 then becomes

$$\mu \approx \mu^\circ(\text{g}) + RT \ln \frac{p}{p^\circ} + Bp \quad (7.9.9)$$

The expressions in the last column of Table 7.5 use this equation of state. We can see what the expressions look like if the gas is ideal simply by setting B equal to zero. They show that when the pressure of an ideal gas increases at constant temperature, G_m and A_m increase, S_m decreases, and U_m , H_m , and $C_{p,m}$ are unaffected.

PROBLEMS

An underlined problem number or problem-part letter indicates that the numerical answer appears in Appendix I.

7.1 Derive the following relations from the definitions of α , κ_T , and ρ :

$$\alpha = -\frac{1}{\rho} \left(\frac{\partial \rho}{\partial T} \right)_p \quad \kappa_T = \frac{1}{\rho} \left(\frac{\partial \rho}{\partial p} \right)_T$$

7.2 Use equations in this chapter to derive the following expressions for an ideal gas:

$$\alpha = 1/T \quad \kappa_T = 1/p$$

7.3 For a gas with the simple equation of state

$$V_m = \frac{RT}{p} + B$$

(Eq. 2.2.8), where B is the second virial coefficient (a function of T), find expressions for α , κ_T , and $(\partial U_m / \partial V)_T$ in terms of dB/dT and other state functions.

7.4 Show that when the virial equation $pV_m = RT(1 + B_p p + C_p p^2 + \dots)$ (Eq. 2.2.3) adequately represents the equation of state of a real gas, the Joule–Thomson coefficient is given by

$$\mu_{JT} = \frac{RT^2[dB_p/dT + (dC_p/dT)p + \dots]}{C_{p,m}}$$

Note that the limiting value at low pressure, $RT^2(dB_p/dT)/C_{p,m}$, is not necessarily equal to zero even though the equation of state approaches that of an ideal gas in this limit.

7.5 The quantity $(\partial T / \partial V)_U$ is called the *Joule coefficient*. James Joule attempted to evaluate this quantity by measuring the temperature change accompanying the expansion of air into a vacuum—the “Joule experiment.” Write an expression for the total differential of U with T and V as independent variables, and by a procedure similar to that used in Sec. 7.5.2 show that the Joule coefficient is equal to

$$\frac{p - \alpha T / \kappa_T}{C_V}$$

7.6 p – V – T data for several organic liquids were measured by Gibson and Loeffler.¹¹ The following formulas describe the results for aniline.

Molar volume as a function of temperature at $p = 1$ bar (298–358 K):

$$V_m = a + bT + cT^2 + dT^3$$

where the parameters have the values

$$\begin{aligned} a &= 69.287 \text{ cm}^3 \text{ mol}^{-1} & c &= -1.0443 \times 10^{-4} \text{ cm}^3 \text{ K}^{-2} \text{ mol}^{-1} \\ b &= 0.08852 \text{ cm}^3 \text{ K}^{-1} \text{ mol}^{-1} & d &= 1.940 \times 10^{-7} \text{ cm}^3 \text{ K}^{-3} \text{ mol}^{-1} \end{aligned}$$

Molar volume as a function of pressure at $T = 298.15$ K (1–1000 bar):

$$V_m = e - f \ln(g + p/\text{bar})$$

where the parameter values are

$$e = 156.812 \text{ cm}^3 \text{ mol}^{-1} \quad f = 8.5834 \text{ cm}^3 \text{ mol}^{-1} \quad g = 2006.6$$

¹¹Ref. [70].

- (a) Use these formulas to evaluate α , κ_T , $(\partial p/\partial T)_V$, and $(\partial U/\partial V)_T$ (the internal pressure) for aniline at $T = 298.15$ K and $p = 1.000$ bar.
- (b) Estimate the pressure increase if the temperature of a fixed amount of aniline is increased by 0.10 K at constant volume.
- 7.7** (a) From the total differential of H with T and p as independent variables, derive the relation $(\partial C_{p,m}/\partial p)_T = -T(\partial^2 V_m/\partial T^2)_p$.
- (b) Evaluate $(\partial C_{p,m}/\partial p)_T$ for liquid aniline at 300.0 K and 1 bar using data in Prob. 7.6.
- 7.8** (a) From the total differential of V with T and p as independent variables, derive the relation $(\partial \alpha/\partial p)_T = -(\partial \kappa_T/\partial T)_p$.
- (b) Use this relation to estimate the value of α for benzene at 25 °C and 500 bar, given that the value of α is $1.2 \times 10^{-3} \text{ K}^{-1}$ at 25 °C and 1 bar. (Use information from Fig. 7.2 on page 168.)
- 7.9** Certain equations of state supposed to be applicable to nonpolar liquids and gases are of the form $p = Tf(V_m) - a/V_m^2$, where $f(V_m)$ is a function of the molar volume only and a is a constant.
- (a) Show that the van der Waals equation of state $(p + a/V_m^2)(V_m - b) = RT$ (where a and b are constants) is of this form.
- (b) Show that any fluid with an equation of state of this form has an internal pressure equal to a/V_m^2 .
- 7.10** Suppose that the molar heat capacity at constant pressure of a substance has a temperature dependence given by $C_{p,m} = a + bT + cT^2$, where a , b , and c are constants. Consider the heating of an amount n of the substance from T_1 to T_2 at constant pressure. Find expressions for ΔH and ΔS for this process in terms of a , b , c , n , T_1 , and T_2 .
- 7.11** At $p = 1$ atm, the molar heat capacity at constant pressure of aluminum is given by

$$C_{p,m} = a + bT$$

where the constants have the values

$$a = 20.67 \text{ J K}^{-1} \text{ mol}^{-1} \quad b = 0.01238 \text{ J K}^{-2} \text{ mol}^{-1}$$

Calculate the quantity of electrical work needed to heat 2.000 mol of aluminum from 300.00 K to 400.00 K at 1 atm in an adiabatic enclosure.

- 7.12** The temperature dependence of the standard molar heat capacity of gaseous carbon dioxide in the temperature range 298 K–2000 K is given by

$$C_{p,m}^\circ = a + bT + \frac{c}{T^2}$$

where the constants have the values

$$a = 44.2 \text{ J K}^{-1} \text{ mol}^{-1} \quad b = 8.8 \times 10^{-3} \text{ J K}^{-2} \text{ mol}^{-1} \quad c = -8.6 \times 10^5 \text{ J K mol}^{-1}$$

Calculate the enthalpy and entropy changes when one mole of CO_2 is heated at 1 bar from 300.00 K to 800.00 K. You can assume that at this pressure $C_{p,m}$ is practically equal to $C_{p,m}^\circ$.

- 7.13** This problem concerns gaseous carbon dioxide. At 400 K, the relation between p and V_m at pressures up to at least 100 bar is given to good accuracy by a virial equation of state truncated

at the second virial coefficient, B . In the temperature range 300 K–800 K the dependence of B on temperature is given by

$$B = a' + b'T + c'T^2 + d'T^3$$

where the constants have the values

$$a' = -521 \text{ cm}^3 \text{ mol}^{-1}$$

$$b' = 2.08 \text{ cm}^3 \text{ K}^{-1} \text{ mol}^{-1}$$

$$c' = -2.89 \times 10^{-3} \text{ cm}^3 \text{ K}^{-2} \text{ mol}^{-1}$$

$$d' = 1.397 \times 10^{-6} \text{ cm}^3 \text{ K}^{-3} \text{ mol}^{-1}$$

(a) From information in Prob. 7.12, calculate the standard molar heat capacity at constant pressure, $C_{p,m}^\circ$, at $T = 400.0 \text{ K}$.

(b) Estimate the value of $C_{p,m}$ under the conditions $T = 400.0 \text{ K}$ and $p = 100.0 \text{ bar}$.

7.14 A chemist, needing to determine the specific heat capacity of a certain liquid but not having an electrically heated calorimeter at her disposal, used the following simple procedure known as *drop calorimetry*. She placed 500.0 g of the liquid in a thermally insulated container equipped with a lid and a thermometer. After recording the initial temperature of the liquid, 24.80 °C, she removed a 60.17-g block of aluminum metal from a boiling water bath at 100.00 °C and quickly immersed it in the liquid in the container. After the contents of the container had become thermally equilibrated, she recorded a final temperature of 27.92 °C. She calculated the specific heat capacity C_p/m of the liquid from these data, making use of the molar mass of aluminum ($M = 26.9815 \text{ g mol}^{-1}$) and the formula for the molar heat capacity of aluminum given in Prob. 7.11.

(a) From these data, find the specific heat capacity of the liquid under the assumption that its value does not vary with temperature. Hint: Treat the temperature equilibration process as adiabatic and isobaric ($\Delta H = 0$), and equate ΔH to the sum of the enthalpy changes in the two phases.

(b) Show that the value obtained in part (a) is actually an average value of C_p/m over the temperature range between the initial and final temperatures of the liquid given by

$$\frac{\int_{T_1}^{T_2} (C_p/m) dT}{T_2 - T_1}$$

7.15 Suppose a gas has the virial equation of state $pV_m = RT(1 + B_p p + C_p p^2)$, where B_p and C_p depend only on T , and higher powers of p can be ignored.

(a) Derive an expression for the fugacity coefficient, ϕ , of this gas as a function of p .

(b) For $\text{CO}_2(\text{g})$ at 0.00 °C, the virial coefficients have the values $B_p = -6.67 \times 10^{-3} \text{ bar}^{-1}$ and $C_p = -3.4 \times 10^{-5} \text{ bar}^{-2}$. Evaluate the fugacity f at 0.00 °C and $p = 20.0 \text{ bar}$.

7.16 Table 7.6 on the next page lists values of the molar volume of gaseous H_2O at 400.00 °C and 12 pressures.

(a) Evaluate the fugacity coefficient and fugacity of $\text{H}_2\text{O}(\text{g})$ at 400.00 °C and 200 bar.

(b) Show that the second virial coefficient B in the virial equation of state, $pV_m = RT(1 + B/V_m + C/V_m^2 + \dots)$, is given by

$$B = RT \lim_{p \rightarrow 0} \left(\frac{V_m}{RT} - \frac{1}{p} \right)$$

where the limit is taken at constant T . Then evaluate B for $\text{H}_2\text{O}(\text{g})$ at 400.00 °C.

Table 7.6 Molar volume of H₂O(g) at 400.00 °C^a

$p/10^5 \text{ Pa}$	$V_m/10^{-3} \text{ m}^3 \text{ mol}^{-1}$	$p/10^5 \text{ Pa}$	$V_m/10^{-3} \text{ m}^3 \text{ mol}^{-1}$
1	55.896	100	0.47575
10	5.5231	120	0.37976
20	2.7237	140	0.31020
40	1.3224	160	0.25699
60	0.85374	180	0.21447
80	0.61817	200	0.17918

^abased on data in Ref. [75]

PHASE TRANSITIONS AND EQUILIBRIA OF PURE SUBSTANCES

A system of two or more phases of a single substance, in the absence of internal constraints, is in an equilibrium state when each phase has the same temperature, the same pressure, and the same chemical potential. This chapter describes the derivation and consequences of this simple principle, the general appearance of phase diagrams of single-substance systems, and quantitative aspects of the equilibrium phase transitions of these systems.

8.1 Phase Equilibria

8.1.1 Equilibrium conditions

If the state of an isolated system is an equilibrium state, this state does not change over time (Sec. 2.4.4). We expect an isolated system that is *not* in an equilibrium state to undergo a spontaneous, irreversible process and eventually to reach an equilibrium state. Just how rapidly this process occurs is a matter of kinetics, not thermodynamics. During this irreversible adiabatic process, the entropy increases until it reaches a maximum in the equilibrium state.

A general procedure will now be introduced for finding conditions for equilibrium with given constraints. The procedure is applied to phase equilibria of single-substance, multiphase systems in the next section, to transfer equilibria in multicomponent, multiphase systems in Sec. 9.2.7, and to reaction equilibria in Sec. 11.7.3.

The procedure has five steps:

1. Write an expression for the total differential of the internal energy U consistent with any constraints and with the number of independent variables of the system.
2. Impose conditions of isolation for the system, including $dU = 0$, thereby reducing the number of independent variables.
3. Designate a particular phase, α' , as a reference phase and make the substitution $dS^{\alpha'} = dS - \sum_{\alpha \neq \alpha'} dS^{\alpha}$. (This is valid because entropy is extensive: $S = \sum_{\alpha} S^{\alpha}$, $dS = \sum_{\alpha} dS^{\alpha}$.)
4. Rearrange to obtain an expression for the total differential of the entropy consistent with the reduced number of independent variables.

5. The conditions for an equilibrium state are those that make the infinitesimal entropy change, dS , equal to zero for all infinitesimal changes of the independent variables of the isolated system.

8.1.2 Equilibrium in a multiphase system

In this section we consider a system of a single substance in two or more uniform phases with distinctly different intensive properties. For instance, one phase might be a liquid and another a gas. We assume the phases are not separated by internal partitions, so that there is no constraint preventing the transfer of matter and energy among the phases. (A tall column of gas in a gravitational field is a different kind of system in which intensive properties of an equilibrium state vary continuously with elevation; this case will be discussed in Sec. 8.1.4.)

Phase α' will be the reference phase. Since internal energy is extensive, we can write $U = U^{\alpha'} + \sum_{\alpha \neq \alpha'} U^{\alpha}$ and $dU = dU^{\alpha'} + \sum_{\alpha \neq \alpha'} dU^{\alpha}$. We assume any changes are slow enough to allow each phase to be practically uniform at all times. Treating each phase as an open subsystem with expansion work only, we use the relation $dU = T dS - p dV + \mu dn$ (Eq. 5.2.5) to replace each dU^{α} term:

$$\begin{aligned} dU &= (T^{\alpha'} dS^{\alpha'} - p^{\alpha'} dV^{\alpha'} + \mu^{\alpha'} dn^{\alpha'}) \\ &+ \sum_{\alpha \neq \alpha'} (T^{\alpha} dS^{\alpha} - p^{\alpha} dV^{\alpha} + \mu^{\alpha} dn^{\alpha}) \end{aligned} \quad (8.1.1)$$

This is an expression for the total differential of U when there are no constraints.

We isolate the system by enclosing it in a rigid, stationary adiabatic container. The constraints needed to isolate the system, then, are given by the relations

$$dU = 0 \quad (\text{constant internal energy}) \quad (8.1.2)$$

$$dV^{\alpha'} + \sum_{\alpha \neq \alpha'} dV^{\alpha} = 0 \quad (\text{no expansion work}) \quad (8.1.3)$$

$$dn^{\alpha'} + \sum_{\alpha \neq \alpha'} dn^{\alpha} = 0 \quad (\text{closed system}) \quad (8.1.4)$$

Each of these relations is an independent restriction that reduces the number of independent variables by one. When we substitute expressions for dU , $dV^{\alpha'}$, and $dn^{\alpha'}$ from these relations into Eq. 8.1.1, make the further substitution $dS^{\alpha'} = dS - \sum_{\alpha \neq \alpha'} dS^{\alpha}$, and collect term with the same differentials on the right side, we obtain

$$\begin{aligned} 0 &= T^{\alpha'} dS + \sum_{\alpha \neq \alpha'} (T^{\alpha} - T^{\alpha'}) dS^{\alpha} - \sum_{\alpha \neq \alpha'} (p^{\alpha} - p^{\alpha'}) dV^{\alpha} \\ &+ \sum_{\alpha \neq \alpha'} (\mu^{\alpha} - \mu^{\alpha'}) dn^{\alpha} \end{aligned} \quad (8.1.5)$$

Solving for dS , we obtain

$$\begin{aligned} dS &= \sum_{\alpha \neq \alpha'} \frac{T^{\alpha'} - T^{\alpha}}{T^{\alpha'}} dS^{\alpha} - \sum_{\alpha \neq \alpha'} \frac{p^{\alpha'} - p^{\alpha}}{T^{\alpha'}} dV^{\alpha} \\ &+ \sum_{\alpha \neq \alpha'} \frac{\mu^{\alpha'} - \mu^{\alpha}}{T^{\alpha'}} dn^{\alpha} \end{aligned} \quad (8.1.6)$$

This is an expression for the total differential of S in the isolated system.

In an isolated system, an equilibrium state cannot change spontaneously to a different state. Once the isolated system has reached an equilibrium state, an imagined finite change of any of the independent variables consistent with the constraints (a so-called *virtual displacement*) corresponds to an impossible process with an entropy decrease. Thus, the equilibrium state has the *maximum* entropy that is possible for the isolated system. In order for S to be a maximum, dS must be zero for an infinitesimal change of any of the independent variables of the isolated system.

This requirement is satisfied in the case of the multiphase system only if the coefficient of each term in the sums on the right side of Eq. 8.1.6 is zero. Therefore, in an equilibrium state the temperature of each phase is equal to the temperature $T^{\alpha'}$ of the reference phase, the pressure of each phase is equal to $p^{\alpha'}$, and the chemical potential in each phase is equal to $\mu^{\alpha'}$. That is, at equilibrium the temperature, pressure, and chemical potential are uniform throughout the system. These are, respectively, the conditions described in Sec. 2.4.4 of *thermal equilibrium*, *mechanical equilibrium*, and *transfer equilibrium*. These conditions must hold in order for a multiphase system of a pure substance without internal partitions to be in an equilibrium state, regardless of the process by which the system attains that state.

8.1.3 Simple derivation of equilibrium conditions

Here is a simpler, less formal derivation of the three equilibrium conditions in a multiphase system of a single substance.

It is intuitively obvious that, unless there are special constraints (such as internal partitions), an equilibrium state must have thermal and mechanical equilibrium. A temperature difference between two phases would cause a spontaneous transfer of heat from the warmer to the cooler phase; a pressure difference would cause spontaneous flow of matter.

When some of the substance is transferred from one phase to another under conditions of constant T and p , the intensive properties of each phase remains the same including the chemical potential. The chemical potential of a pure phase is the Gibbs energy per amount of substance in the phase. We know that in a closed system of constant T and p with expansion work only, the total Gibbs energy decreases during a spontaneous process and is constant during a reversible process (Eq. 5.8.6). The Gibbs energy will decrease only if there is a transfer of substance from a phase of higher chemical potential to a phase of lower chemical potential, and this will be a spontaneous change. No spontaneous transfer is possible if both phases have the same chemical potential, so this is a condition for an equilibrium state.

8.1.4 Tall column of gas in a gravitational field

The earth's gravitational field is an example of an external force field that acts on a system placed in it. Usually we ignore its effects on the state of the system. If, however, the system's vertical extent is considerable we must take the presence of the field into account to explain, for example, why gas pressure varies with elevation in an equilibrium state.

A tall column of gas whose intensive properties are a function of elevation may be treated as an infinite number of uniform phases, each of infinitesimal vertical height. We can approximate this system with a vertical stack of many slab-shaped gas phases, each thin enough to be practically uniform in its intensive properties, as depicted in Fig. 8.1.

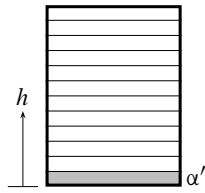

Figure 8.1 Closed system of constant-volume slab-shaped fluid phases stacked in the vertical direction. The shaded phase is reference phase α' .

The system can be isolated from the surroundings by confining the gas in a rigid adiabatic container. In order to be able to associate each of the thin slab-shaped phases with a definite constant elevation, we specify that the volume of each phase is constant so that in the rigid container the vertical thickness of a phase cannot change.

We can use the phase of lowest elevation as the reference phase α' , as indicated in the figure. We repeat the derivation of Sec. 8.1.2 with one change: for each phase α the volume change dV^α is set equal to zero. Then the second sum on the right side of Eq. 8.1.6, with terms proportional to dV^α , drops out and we are left with

$$dS = \sum_{\alpha \neq \alpha'} \frac{T^{\alpha'} - T^\alpha}{T^{\alpha'}} dS^\alpha + \sum_{\alpha \neq \alpha'} \frac{\mu^{\alpha'} - \mu^\alpha}{T^{\alpha'}} dn^\alpha \quad (8.1.7)$$

In the equilibrium state of the isolated system, dS is equal to zero for an infinitesimal change of any of the independent variables. In this state, therefore, the coefficient of each term in the sums on the right side of Eq. 8.1.7 must be zero. We conclude that in an equilibrium state of a tall column of a pure gas, *the temperature and chemical potential are uniform throughout*. The equation, however, gives us no information about pressure.

We will use this result to derive an expression for the dependence of the fugacity f on elevation in an equilibrium state. We pick an arbitrary position such as the earth's surface for a reference elevation at which h is zero, and define the standard chemical potential $\mu^\circ(\text{g})$ as the chemical potential of the gas under standard state conditions at this reference elevation. At $h=0$, the chemical potential and fugacity are related by Eq. 7.8.7 which we write in the following form, indicating the elevation in parentheses:

$$\mu(0) = \mu^\circ(\text{g}) + RT \ln \frac{f(0)}{p^\circ} \quad (8.1.8)$$

Imagine a small sample of gas of mass m that is initially at elevation $h=0$. The vertical extent of this sample should be small enough for the variation of the gravitational force field within the sample to be negligible. The gravitational work needed to raise the gas to an arbitrary elevation h is $w' = mgh$ (page 84). We assume this process is carried out reversibly at constant volume and without heat, so that there is no change in T , p , V , S , or f . The internal energy U of the gas must increase by $mgh = nMgh$, where M is the molar mass. Then, because the Gibbs energy G depends on U according to $G = U - TS + pV$, G must also increase by $nMgh$.

The chemical potential μ is the molar Gibbs energy G/n . During the elevation process, f remains the same and μ increases by Mgh :

$$\mu(h) = \mu(0) + Mgh \quad (8.1.9)$$

($f(h)=f(0)$)

From Eqs. 8.1.8 and 8.1.9, we can deduce the following general relation between chemical potential, fugacity, and elevation:

$$\mu(h) = \mu^\circ(\text{g}) + RT \ln \frac{f(h)}{p^\circ} + Mgh \quad (8.1.10)$$

(pure gas in
gravitational field)

Compare this relation with the equation that defines the fugacity when the effect of a gravitational field is negligible: $\mu = \mu^\circ(\text{g}) + RT \ln(f/p^\circ)$ (Eq. 7.8.7 on page 185). The additional term Mgh is needed when the vertical extent of the gas is considerable.

Some thermodynamicists call the expression on the right side of Eq. 8.1.10 the “total chemical potential” or “gravitochemical potential” and reserve the term “chemical potential” for the function $\mu^\circ(\text{g}) + RT \ln(f/p^\circ)$. With these definitions, in an equilibrium state the “total chemical potential” is the same at all elevations and the “chemical potential” decreases with increasing elevation.

This book instead defines the chemical potential μ of a pure substance at any elevation as the molar Gibbs energy at that elevation, as recommended in a 2001 IUPAC technical report.¹ When the chemical potential is defined in this way, it has the same value at all elevations in an equilibrium state.

We know that in the equilibrium state of the gas column, the chemical potential $\mu(h)$ has the same value at each elevation h . Equation 8.1.10 shows that in order for this to be possible, the fugacity must decrease with increasing elevation. By equating expressions from Eq. 8.1.10 for $\mu(h)$ at an arbitrary elevation h , and for $\mu(0)$ at the reference elevation, we obtain

$$\mu^\circ(\text{g}) + RT \ln \frac{f(h)}{p^\circ} + Mgh = \mu^\circ(\text{g}) + RT \ln \frac{f(0)}{p^\circ} \quad (8.1.11)$$

Solving for $f(h)$ gives

$$f(h) = f(0)e^{-Mgh/RT} \quad (8.1.12)$$

(pure gas at equilibrium
in gravitational field)

If we treat the gas as ideal, so that the fugacity equals the pressure, this equation becomes

$$p(h) = p(0)e^{-Mgh/RT} \quad (8.1.13)$$

(pure ideal gas at equilibrium
in gravitational field)

Equation 8.1.13 is the *barometric formula* for a pure ideal gas. It shows that in the equilibrium state of a tall column of an ideal gas, the pressure decreases exponentially with increasing elevation.

¹Ref. [2].

This derivation of the barometric formula has introduced a method that will be used in Sec. 9.8.1 for dealing with *mixtures* in a gravitational field. There is, however, a shorter derivation based on Newton's second law and not involving the chemical potential. Consider one of the thin slab-shaped phases of Fig. 8.1. Let the density of the phase be ρ , the area of each horizontal face be A_s , and the thickness of the slab be δh . The mass of the phase is then $m = \rho A_s \delta h$. The pressure difference between the top and bottom of the phase is δp . Three vertical forces act on the phase: an upward force pA_s at its lower face, a downward force $-(p + \delta p)A_s$ at its upper face, and a downward gravitational force $-mg = -\rho A_s g \delta h$. If the phase is at rest, the net vertical force is zero: $pA_s - (p + \delta p)A_s - \rho A_s g \delta h = 0$, or $\delta p = -\rho g \delta h$. In the limit as the number of phases becomes infinite and δh and δp become infinitesimal, this becomes

$$dp = -\rho g dh \quad (8.1.14)$$

(fluid at equilibrium
in gravitational field)

Equation 8.1.14 is a general relation between changes in elevation and hydrostatic pressure in *any* fluid. To apply it to an ideal gas, we replace the density by $\rho = nM/V = M/V_m = Mp/RT$ and rearrange to $dp/p = -(gM/RT) dh$. Treating g and T as constants, we integrate from $h=0$ to an arbitrary elevation h and obtain the same result as Eq. 8.1.13.

8.1.5 The pressure in a liquid droplet

The equilibrium shape of a small liquid droplet surrounded by vapor of the same substance, when the effects of gravity and other external forces are negligible, is spherical. This is the result of the surface tension of the liquid–gas interface which acts to minimize the ratio of surface to volume. The interface acts somewhat like the stretched membrane of an inflated balloon, resulting in a greater pressure inside the droplet than the pressure of the vapor in equilibrium with it.

We can derive the pressure difference by considering a closed system containing a spherical liquid droplet and surrounding vapor. We treat both phases as open subsystems. An infinitesimal change dU of the internal energy is the sum of contributions from the liquid and gas phases and from the surface work γdA_s , where γ is the surface tension of the liquid–gas interface and A_s is the surface area of the droplet (Sec. 5.7):

$$\begin{aligned} dU &= dU^l + dU^g + \gamma dA_s \\ &= T^l dS^l - p^l dV^l + \mu^l dn^l \\ &\quad + T^g dS^g - p^g dV^g + \mu^g dn^g + \gamma dA_s \end{aligned} \quad (8.1.15)$$

Note that Eq. 8.1.15 is not an expression for the total differential of U , because V^l and A_s are not independent variables. A derivation by a procedure similar to the one used in Sec. 8.1.2 shows that at equilibrium the liquid and gas have equal temperatures and equal chemical potentials, and the pressure in the droplet is greater than the gas pressure by an amount that depends on r :

$$p^l = p^g + \frac{2\gamma}{r} \quad (8.1.16)$$

Equation 8.1.16 is the *Laplace equation*. The pressure difference is significant if r is small, and decreases as r increases. The limit $r \rightarrow \infty$ represents the flat surface of bulk liquid with p^l equal to p^g .

The derivation of Eq. 8.1.16 is left as an exercise (Prob. 8.1). The Laplace equation is valid also for a liquid droplet in which the liquid and the surrounding gas may both be mixtures (Prob. 9.3 on page 282).

The Laplace equation can also be applied to the pressure in a gas *bubble* surrounded by liquid. In this case the liquid and gas phases switch roles, and the equation becomes $p^g = p^l + 2\gamma/r$.

8.1.6 The number of independent variables

From this point on in this book, unless stated otherwise, the discussions of multiphase systems will implicitly assume the existence of thermal, mechanical, and transfer equilibrium. Equations will not explicitly show these equilibria as a condition of validity.

In the rest of this chapter, we shall assume the state of each phase can be described by the usual variables: temperature, pressure, and amount. That is, variables such as elevation in a gravitational field, interface surface area, and extent of stretching of a solid, are not relevant.

How many of the usual variables of an open multiphase one-substance equilibrium system are independent? To find out, we go through the following argument. In the absence of any kind of equilibrium, we could treat phase α as having the three independent variables T^α , p^α , and n^α , and likewise for every other phase. A system of P phases without thermal, mechanical, or transfer equilibrium would then have $3P$ independent variables.

We must decide how to count the number of phases. It is usually of no thermodynamic significance whether a phase, with particular values of its intensive properties, is contiguous. For instance, splitting a crystal into several pieces is not usually considered to change the number of phases or the state of the system, provided the increased surface area makes no significant contribution to properties such as internal energy. Thus, the number of phases P refers to the number of different *kinds* of phases.

Each independent relation resulting from equilibrium imposes a restriction on the system and reduces the number of independent variables by one. A two-phase system with thermal equilibrium has the single relation $T^\beta = T^\alpha$. For a three-phase system, there are two such relations that are independent, for instance $T^\beta = T^\alpha$ and $T^\gamma = T^\alpha$. (The additional relation $T^\gamma = T^\beta$ is not independent since we may deduce it from the other two.) In general, thermal equilibrium gives $P - 1$ independent relations among temperatures.

By the same reasoning, mechanical equilibrium involves $P - 1$ independent relations among pressures, and transfer equilibrium involves $P - 1$ independent relations among chemical potentials.

The total number of independent relations for equilibrium is $3(P - 1)$, which we subtract from $3P$ (the number of independent variables in the absence of equilibrium) to obtain the number of independent variables in the equilibrium system: $3P - 3(P - 1) = 3$. Thus, *an open single-substance system with any number of phases has at equilibrium three independent variables*. For example, in equilibrium states of a two-phase system we may vary T , n^α , and n^β independently, in which case p is a dependent variable; for a given value of T , the value of p is the one that allows both phases to have the same chemical potential.

8.1.7 The Gibbs phase rule for a pure substance

The complete description of the state of a system must include the value of an *extensive* variable of each phase (e.g., the volume, mass, or amount) in order to specify how much of the phase is present. For an equilibrium system of P phases with a total of 3 independent variables, we may choose the remaining $3 - P$ variables to be *intensive*. The number of these intensive independent variables is called the **number of degrees of freedom** or **variance**, F , of the system:

$$F = 3 - P \quad (8.1.17)$$

(pure substance)

The application of the phase rule to multicomponent systems will be taken up in Sec. 13.1. Equation 8.1.17 is a special case, for $C = 1$, of the more general Gibbs phase rule $F = C - P + 2$.

We may interpret the variance F in either of two ways:

- F is the number of intensive variables needed to describe an equilibrium state, in addition to the amount of each phase;
- F is the maximum number of intensive properties that we may vary independently while the phases remain in equilibrium.

A system with two degrees of freedom is called *bivariant*, one with one degree of freedom is *univariant*, and one with no degrees of freedom is *invariant*. For a system of a pure substance, these three cases correspond to one, two, and three phases respectively. For instance, a system of liquid and gaseous H_2O (and no other substances) is univariant ($F = 3 - P = 3 - 2 = 1$); we are able to independently vary only one intensive property, such as T , while the liquid and gas remain in equilibrium.

8.2 Phase Diagrams of Pure Substances

A **phase diagram** is a two-dimensional map showing which phase or phases are able to exist in an equilibrium state under given conditions. This chapter describes pressure–volume and pressure–temperature phase diagrams for a single substance, and Chap. 13 will describe numerous types of phase diagrams for multicomponent systems.

8.2.1 Features of phase diagrams

Two-dimensional phase diagrams for a single-substance system can be generated as projections of a three-dimensional surface in a coordinate system with Cartesian axes p , V/n , and T . A point on the three-dimensional surface corresponds to a physically-realizable combination of values, for an equilibrium state of the system containing a total amount n of the substance, of the variables p , V/n , and T .

The concepts needed to interpret single-substance phase diagrams will be illustrated with carbon dioxide.

Three-dimensional surfaces for carbon dioxide are shown at two different scales in Fig. 8.2 on the next page and in Fig. 8.3 on page 204. In these figures, some areas of the surface are labeled with a single physical state: solid, liquid, gas, or supercritical fluid. A point

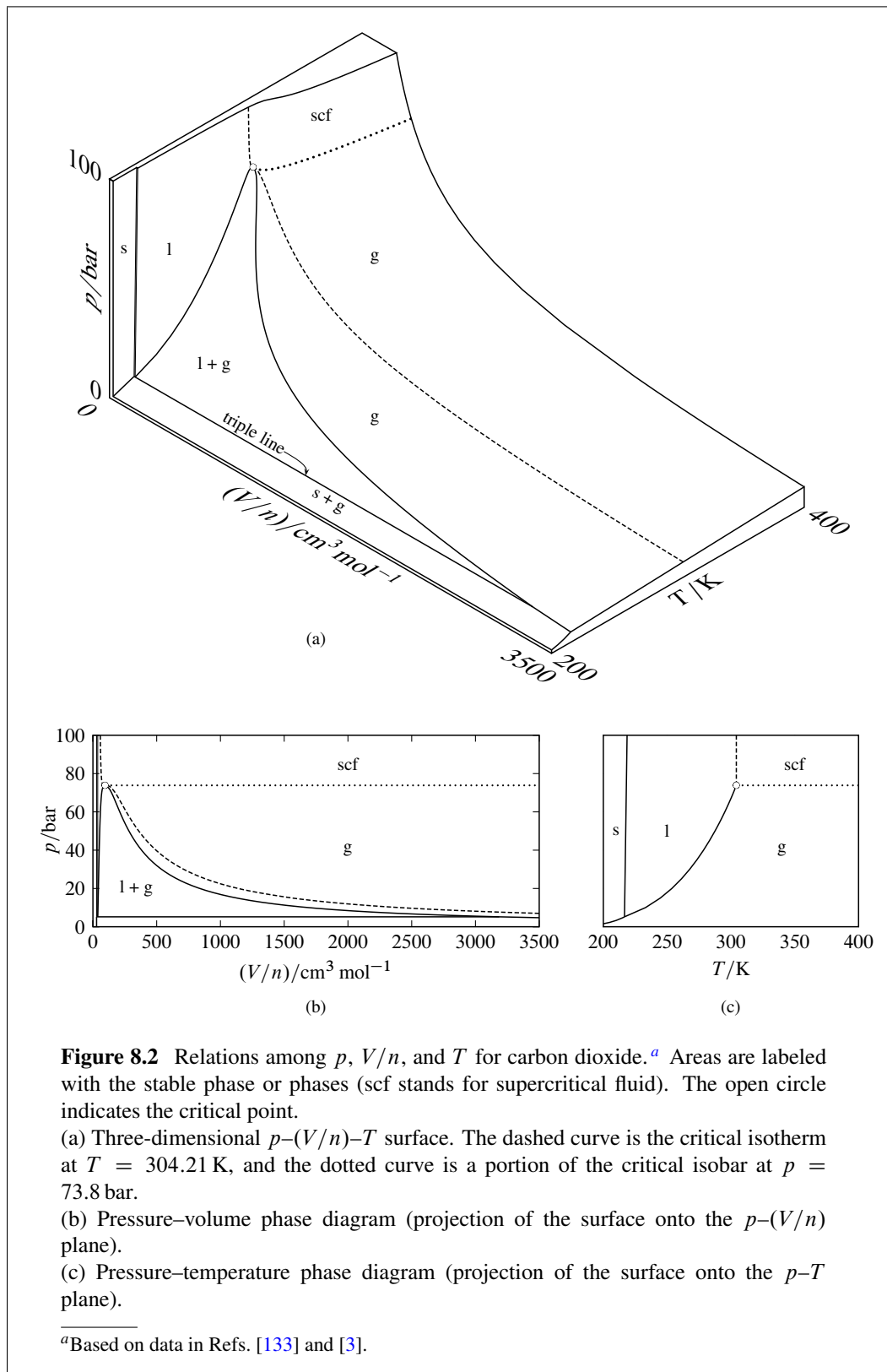

Figure 8.2 Relations among p , V/n , and T for carbon dioxide.^a Areas are labeled with the stable phase or phases (scf stands for supercritical fluid). The open circle indicates the critical point.

(a) Three-dimensional p – (V/n) – T surface. The dashed curve is the critical isotherm at $T = 304.21 \text{ K}$, and the dotted curve is a portion of the critical isobar at $p = 73.8 \text{ bar}$.

(b) Pressure–volume phase diagram (projection of the surface onto the p – (V/n) plane).

(c) Pressure–temperature phase diagram (projection of the surface onto the p – T plane).

^aBased on data in Refs. [133] and [3].

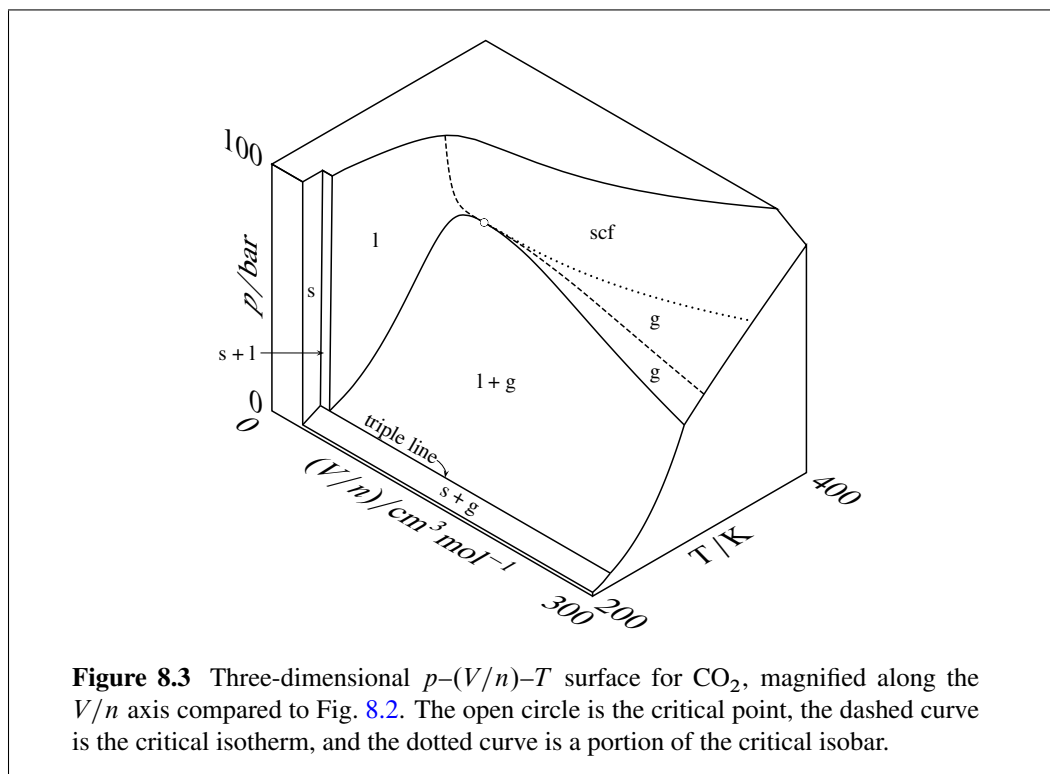

in one of these areas corresponds to an equilibrium state of the system containing a single phase of the labeled physical state. The shape of the surface in this one-phase area gives the equation of state of the phase (i.e., the dependence of one of the variables on the other two). A point in an area labeled with two physical states corresponds to two coexisting phases. The **triple line** is the locus of points for all possible equilibrium systems of three coexisting phases, which in this case are solid, liquid, and gas. A point on the triple line can also correspond to just one or two phases (see the discussion on page 205).

The two-dimensional projections shown in Figs. 8.2(b) and 8.2(c) are pressure–volume and pressure–temperature phase diagrams. Because all phases of a multiphase equilibrium system have the same temperature and pressure,² the projection of each two-phase area onto the pressure–temperature diagram is a curve, called a **coexistence curve** or **phase boundary**, and the projection of the triple line is a point, called a **triple point**.

How may we use a phase diagram? The two axes represent values of two independent variables, such as p and V/n or p and T . For given values of these variables, we place a point on the diagram at the intersection of the corresponding coordinates; this is the **system point**. Then depending on whether the system point falls in an area or on a coexistence curve, the diagram tells us the number and kinds of phases that can be present in the equilibrium system.

If the system point falls within an area labeled with the physical state of a *single* phase, only that one kind of phase can be present in the equilibrium system. A system containing a pure substance in a single phase is bivariant ($F = 3 - 1 = 2$), so we may vary two intensive properties independently. That is, the system point may move independently along two

²This statement assumes there are no constraints such as internal adiabatic partitions.

coordinates (p and V/n , or p and T) and still remain in the one-phase area of the phase diagram. When V and n refer to a single phase, the variable V/n is the molar volume V_m in the phase.

If the system point falls in an area of the pressure–volume phase diagram labeled with symbols for *two* phases, these two phases coexist in equilibrium. The phases have the same pressure and different molar volumes. To find the molar volumes of the individual phases, we draw a horizontal line of constant pressure, called a **tie line**, through the system point and extending from one edge of the area to the other. The horizontal position of each end of the tie line, where it terminates at the boundary with a one-phase area, gives the molar volume in that phase in the two-phase system. For an example of a tie line, see Fig. 8.9 on page 210.

The triple line on the pressure–volume diagram represents the range of values of V/n in which three phases (solid, liquid, and gas) can coexist at equilibrium.³ A three-phase one-component system is invariant ($F = 3 - 3 = 0$); there is only one temperature (the triple-point temperature T_{tp}) and one pressure (the triple-point pressure p_{tp}) at which the three phases can coexist. The values of T_{tp} and p_{tp} are unique to each substance, and are shown by the position of the triple point on the pressure–temperature phase diagram. The molar volumes in the three coexisting phases are given by the values of V/n at the three points on the pressure–volume diagram where the triple line touches a one-phase area. These points are at the two ends and an intermediate position of the triple line. If the system point is at either end of the triple line, only the one phase of corresponding molar volume at temperature T_{tp} and pressure p_{tp} can be present. When the system point is on the triple line anywhere between the two ends, either two or three phases can be present. If the system point is at the position on the triple line corresponding to the phase of intermediate molar volume, there might be only that one phase present.

At high pressures, a substance may have additional triple points for two solid phases and the liquid, or for three solid phases. This is illustrated by the pressure–temperature phase diagram of H_2O in Fig. 8.4 on the next page, which extends to pressures up to 30 kbar. (On this scale, the liquid–gas coexistence curve lies too close to the horizontal axis to be visible.) The diagram shows seven different solid phases of H_2O differing in crystal structure and designated ice I, ice II, and so on. Ice I is the ordinary form of ice, stable below 2 bar. On the diagram are four triple points for two solids and the liquid and three triple points for three solids. Each triple point is invariant. Note how H_2O can exist as solid ice VI or ice VII above its standard melting point of 273 K if the pressure is high enough (“hot ice”).

8.2.2 Two-phase equilibrium

A system containing two phases of a pure substance in equilibrium is univariant. Both phases have the same values of T and of p , but these values are not independent because of the requirement that the phases have equal chemical potentials. We may vary only one intensive variable of a pure substance (such as T or p) independently while two phases coexist in equilibrium.

At a given temperature, the pressure at which solid and gas or liquid and gas are in equilibrium is called the **vapor pressure** or **saturation vapor pressure** of the solid or

³Helium is the only substance lacking a solid–liquid–gas triple line. When a system containing the coexisting liquid and gas of ^4He is cooled to 2.17 K, a triple point is reached in which the third phase is a liquid called He-II, which has the unique property of superfluidity. It is only at high pressures (10 bar or greater) that solid helium can exist.

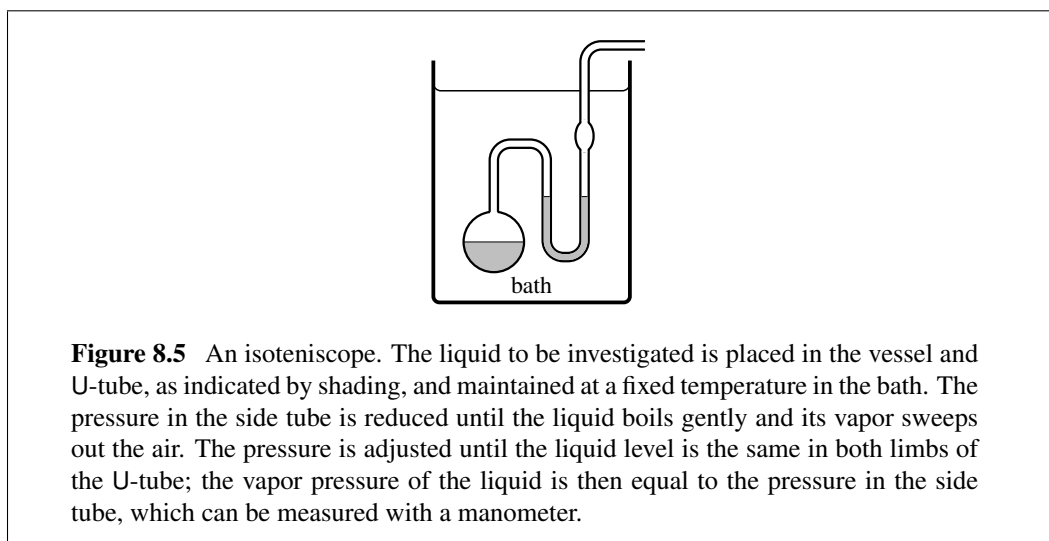
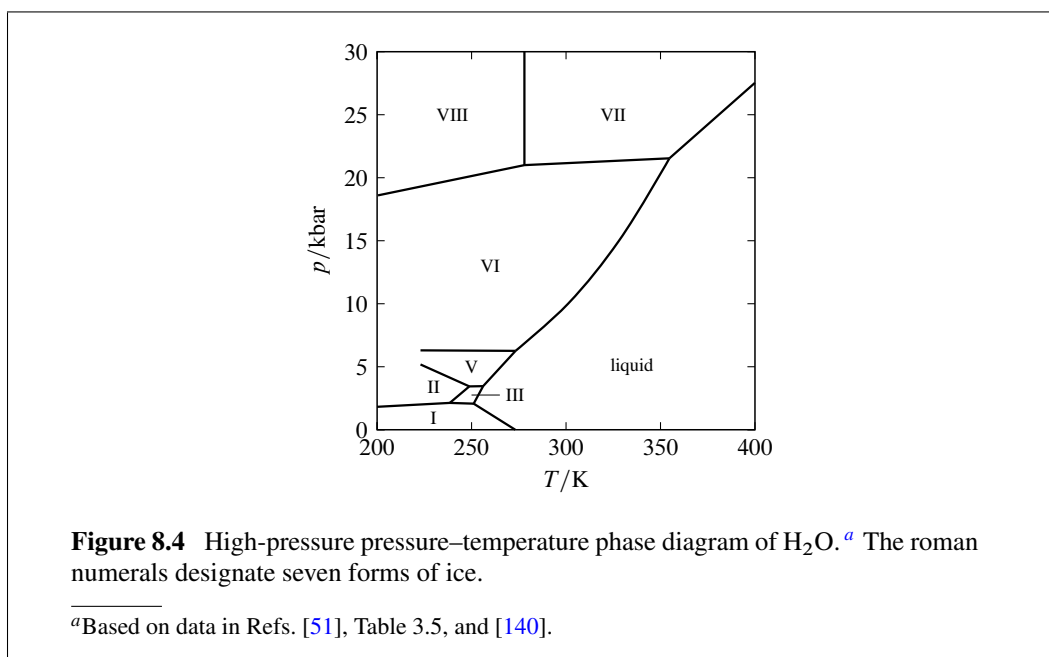

liquid.⁴ The vapor pressure of a solid is sometimes called the **sublimation pressure**. We may measure the vapor pressure of a liquid at a fixed temperature with a simple device called an isoteniscope (Fig. 8.5).

At a given pressure, the **melting point** or **freezing point** is the temperature at which solid and liquid are in equilibrium, the **boiling point** or **saturation temperature** is the temperature at which liquid and gas are in equilibrium, and the **sublimation temperature** or **sublimation point** is the temperature at which solid and gas are in equilibrium.

⁴In a system of more than one substance, *vapor pressure* can refer to the partial pressure of a substance in a gas mixture equilibrated with a solid or liquid of that substance. The effect of total pressure on vapor pressure will be discussed in Sec. 12.8.1. This book refers to the *saturation* vapor pressure of a liquid when it is necessary to indicate that it is the pure liquid and pure gas phases that are in equilibrium at the same pressure.

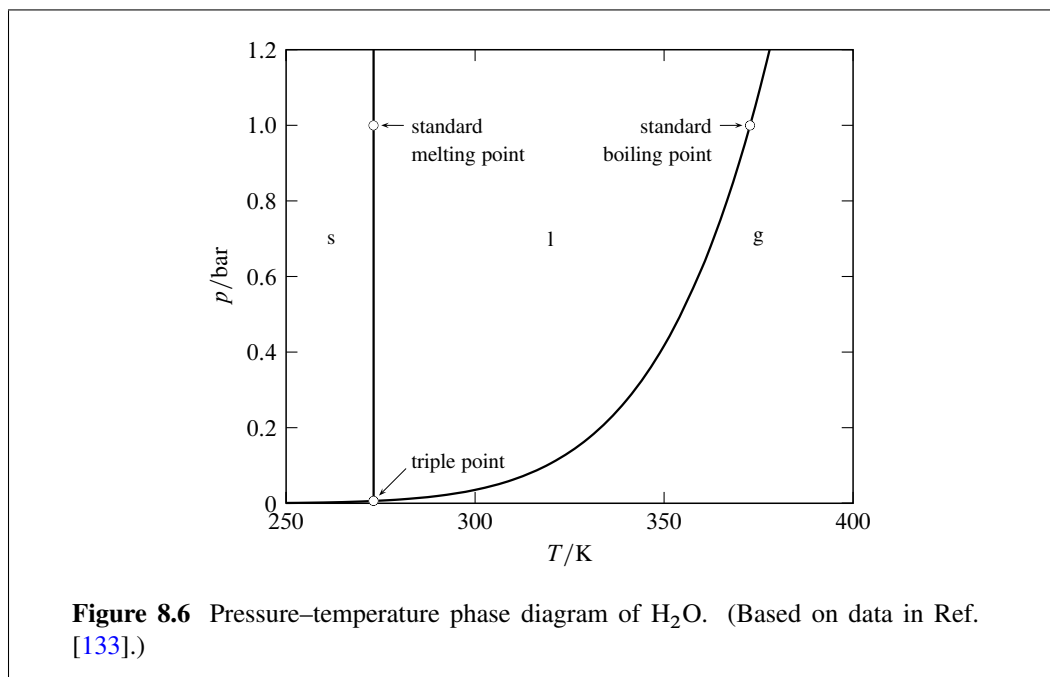

Figure 8.6 Pressure–temperature phase diagram of H_2O . (Based on data in Ref. [133].)

The relation between temperature and pressure in a system with two phases in equilibrium is shown by the coexistence curve separating the two one-phase areas on the pressure–temperature diagram (see Fig. 8.6). Consider the liquid–gas curve. If we think of T as the independent variable, the curve is a **vapor-pressure curve** showing how the vapor pressure of the liquid varies with temperature. If, however, p is the independent variable, then the curve is a **boiling-point curve** showing the dependence of the boiling point on pressure.

The *normal* melting point or boiling point refers to a pressure of one atmosphere, and the *standard* melting point or boiling point refers to the standard pressure. Thus, the normal boiling point of water (99.97°C) is the boiling point at 1 atm; this temperature is also known as the *steam point*. The standard boiling point of water (99.61°C) is the boiling point at the slightly lower pressure of 1 bar.

Coexistence curves will be discussed further in Sec. 8.4.

8.2.3 The critical point

Every substance has a certain temperature, the **critical temperature**, above which only one fluid phase can exist at any volume and pressure (Sec. 2.2.3). The **critical point** is the point on a phase diagram corresponding to liquid–gas coexistence at the critical temperature, and the **critical pressure** is the pressure at this point.

To observe the critical point of a substance experimentally, we can evacuate a glass vessel, introduce an amount of the substance such that V/n is approximately equal to the molar volume at the critical point, seal the vessel, and raise the temperature above the critical temperature. The vessel now contains a single fluid phase. When the substance is slowly cooled to a temperature slightly above the critical temperature, it exhibits a cloudy appearance, a phenomenon called *critical opalescence* (Fig. 8.7 on the next page). The opalescence is the scattering of light caused by large local density fluctuations. At the critical temperature, a meniscus forms between liquid and gas phases of practically the

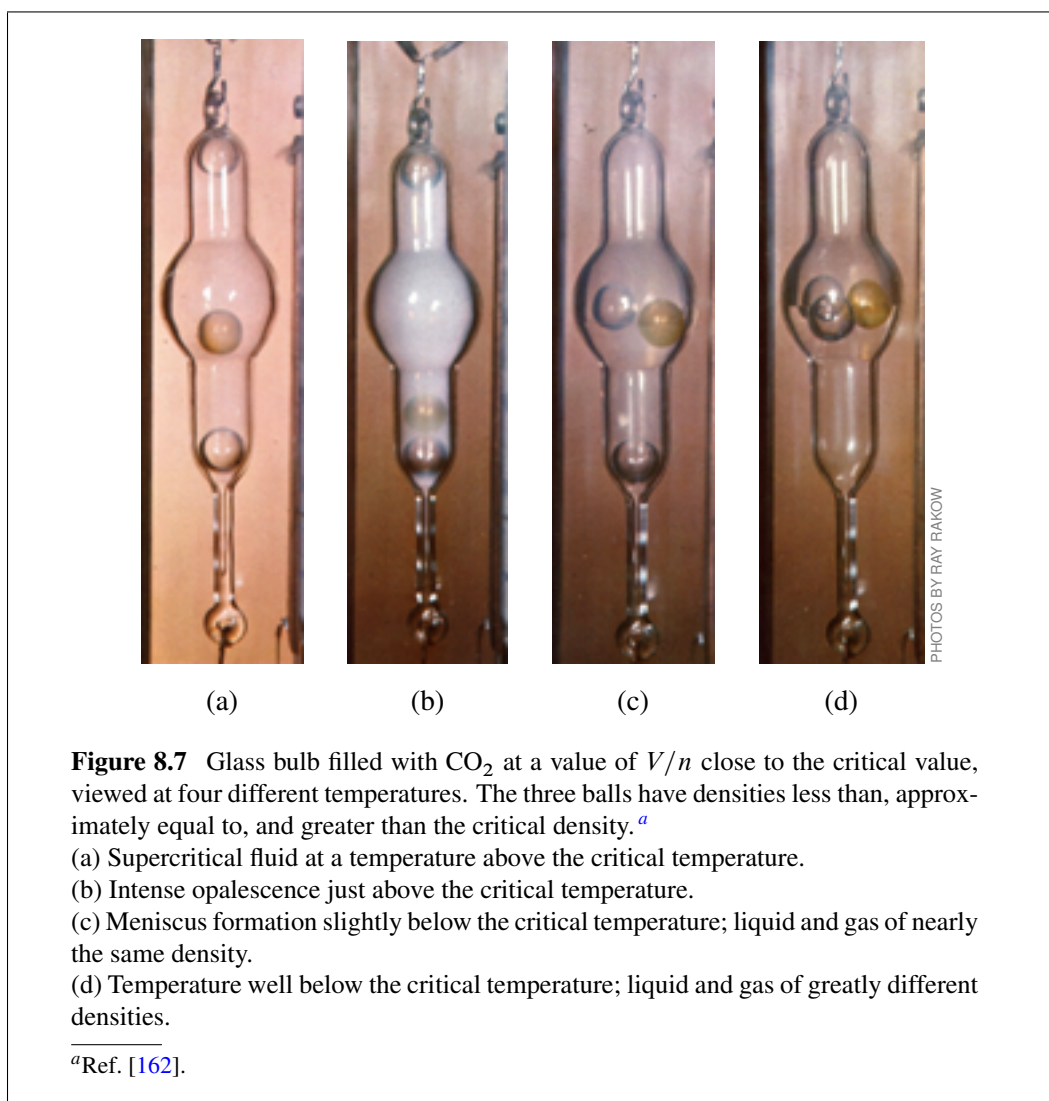

same density. With further cooling, the density of the liquid increases and the density of the gas decreases.

At temperatures above the critical temperature and pressures above the critical pressure, the one existing fluid phase is called a **supercritical fluid**. Thus, a supercritical fluid of a pure substance is a fluid that does not undergo a phase transition to a different fluid phase when we change the pressure at constant temperature or change the temperature at constant pressure.⁵

A fluid in the supercritical region can have a density comparable to that of the liquid, and can be more compressible than the liquid. Under supercritical conditions, a substance is often an excellent solvent for solids and liquids. By varying the pressure or temperature, the solvating power can be changed; by reducing the pressure isothermally, the substance

⁵If, however, we increase p at constant T , the supercritical fluid will change to a solid. In the phase diagram of H₂O, the coexistence curve for ice VII and liquid shown in Fig. 8.4 extends to a higher temperature than the critical temperature of 647 K. Thus, supercritical water can be converted to ice VII by isothermal compression.

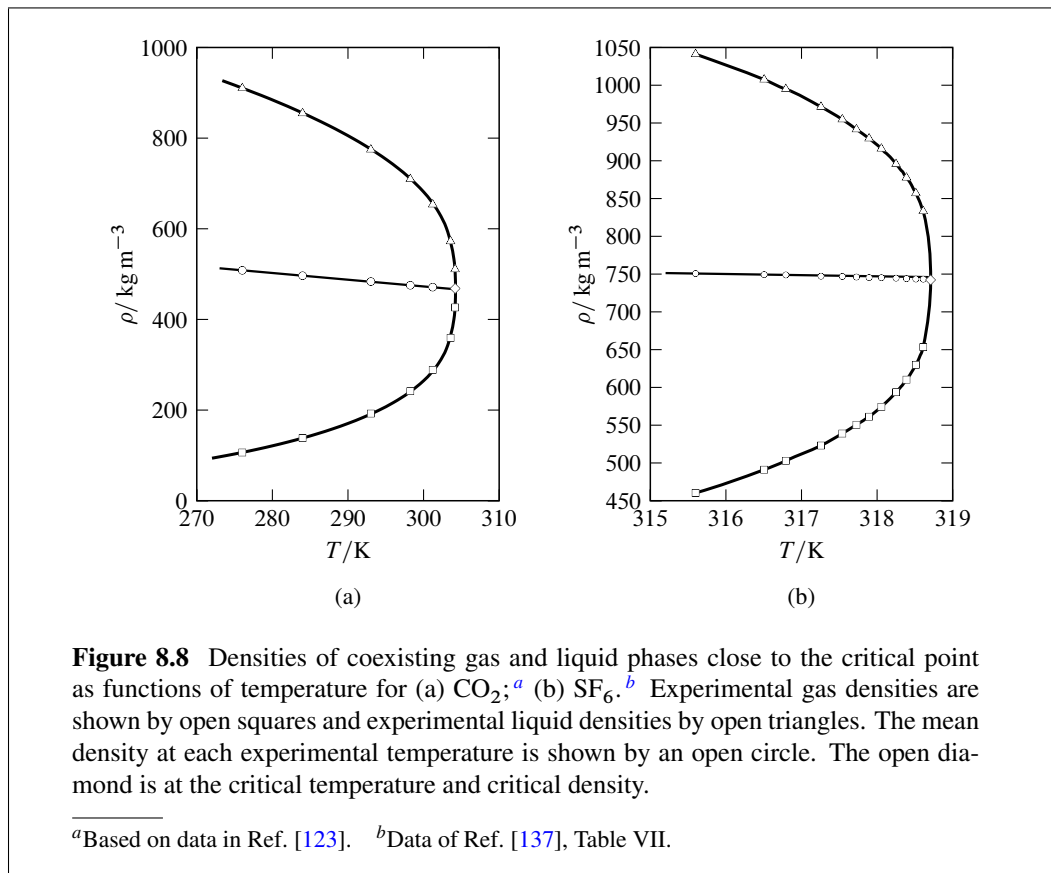

can be easily removed as a gas from dissolved solutes. These properties make supercritical fluids useful for chromatography and solvent extraction.

The critical temperature of a substance can be measured quite accurately by observing the appearance or disappearance of a liquid–gas meniscus, and the critical pressure can be measured at this temperature with a high-pressure manometer. To evaluate the density at the critical point, it is best to extrapolate the mean density of the coexisting liquid and gas phases, $(\rho^l + \rho^g)/2$, to the critical temperature as illustrated in Fig. 8.8. The observation that the mean density closely approximates a linear function of temperature, as shown in the figure, is known as the **law of rectilinear diameters**, or the law of Cailletet and Mathias. This law is an approximation, as can be seen by the small deviation of the mean density of SF_6 from a linear relation very close to the critical point in Fig. 8.8(b). This failure of the law of rectilinear diameters is predicted by recent theoretical treatments.⁶

8.2.4 The lever rule

Consider a single-substance system whose system point is in a two-phase area of a pressure–volume phase diagram. How can we determine the amounts in the two phases?

As an example, let the system contain a fixed amount n of a pure substance divided into liquid and gas phases, at a temperature and pressure at which these phases can coexist in equilibrium. When heat is transferred into the system at this T and p , some of the liquid

⁶Refs. [178] and [10].

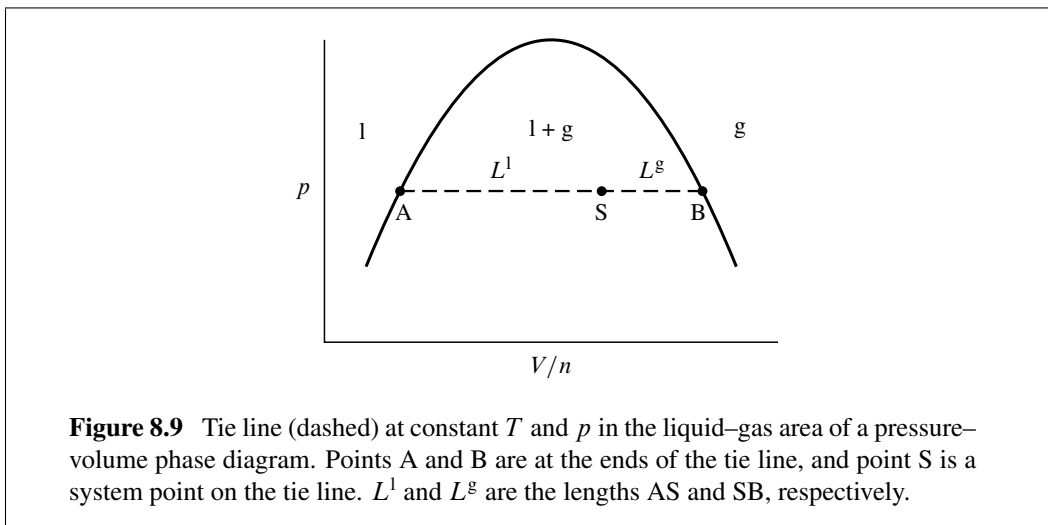

vaporizes by a liquid–gas phase transition and V increases; withdrawal of heat at this T and p causes gas to condense and V to decrease. The molar volumes and other intensive properties of the individual liquid and gas phases remain constant during these changes at constant T and p . On the pressure–volume phase diagram of Fig. 8.9, the volume changes correspond to movement of the system point to the right or left along the tie line AB.

When enough heat is transferred into the system to vaporize all of the liquid at the given T and p , the system point moves to point B at the right end of the tie line. V/n at this point must be the same as the molar volume of the gas, V_m^g . We can see this because the system point could have moved from within the one-phase gas area to this position on the boundary without undergoing a phase transition.

When, on the other hand, enough heat is transferred out of the system to condense all of the gas, the system point moves to point A at the left end of the tie line. V/n at this point is the molar volume of the liquid, V_m^l .

When the system point is at position S on the tie line, both liquid and gas are present. Their amounts must be such that the total volume is the sum of the volumes of the individual phases, and the total amount is the sum of the amounts in the two phases:

$$V = V^l + V^g = n^l V_m^l + n^g V_m^g \quad (8.2.1)$$

$$n = n^l + n^g \quad (8.2.2)$$

The value of V/n at the system point is then given by the equation

$$\frac{V}{n} = \frac{n^l V_m^l + n^g V_m^g}{n^l + n^g} \quad (8.2.3)$$

which can be rearranged to

$$n^l \left(V_m^l - \frac{V}{n} \right) = n^g \left(\frac{V}{n} - V_m^g \right) \quad (8.2.4)$$

The quantities $V_m^l - V/n$ and $V/n - V_m^g$ are the lengths L^1 and L^g , respectively, defined in the figure and measured in units of V/n . This gives us the **lever rule** for liquid–gas

equilibrium:⁷

$$n^l L^l = n^g L^g \quad \text{or} \quad \frac{n^g}{n^l} = \frac{L^l}{L^g} \quad (8.2.5)$$

(coexisting liquid and gas phases of a pure substance)

In Fig. 8.9 the system point S is positioned on the tie line two thirds of the way from the left end, making length L^l twice as long as L^g . The lever rule then gives the ratio of amounts: $n^g/n^l = L^l/L^g = 2$. One-third of the total amount is liquid and two-thirds is gas.

We cannot apply the lever rule to a point on the triple line, because we need more than the value of V/n to determine the relative amounts present in three phases.

We can derive a more general form of the lever rule that will be needed in Chap. 13 for phase diagrams of multicomponent systems. This general form can be applied to any two-phase area of a two-dimensional phase diagram in which a tie-line construction is valid, with the position of the system point along the tie line given by the variable

$$F \stackrel{\text{def}}{=} \frac{a}{b} \quad (8.2.6)$$

where a and b are extensive state functions. (In the pressure–volume phase diagram of Fig. 8.9, these functions are $a = V$ and $b = n$ and the system point position is given by $F = V/n$.) We repeat the steps of the derivation above, labeling the two phases by superscripts α and β instead of l and g . The relation corresponding to Eq. 8.2.4 is

$$b^\alpha(F^\alpha - F) = b^\beta(F - F^\beta) \quad (8.2.7)$$

If L^α and L^β are lengths measured along the tie line from the system point to the ends of the tie line at single phases α and β , respectively, Eq. 8.2.7 is equivalent to the general lever rule

$$b^\alpha L^\alpha = b^\beta L^\beta \quad \text{or} \quad \frac{b^\beta}{b^\alpha} = \frac{L^\alpha}{L^\beta} \quad (8.2.8)$$

8.2.5 Volume properties

Figure 8.10 on the next page is a pressure–volume phase diagram for H_2O . On the diagram are drawn *isotherms* (curves of constant T). These isotherms define the shape of the three-dimensional p –(V/n)– T surface. The area containing the horizontal isotherm segments is the two-phase area for coexisting liquid and gas phases. The boundary of this area is defined by the dotted curve drawn through the ends of the horizontal segments. The one-phase liquid area lies to the left of this curve, the one-phase gas area lies to the right, and the critical point lies at the top.

The diagram contains the information needed to evaluate the molar volume at any temperature and pressure in the one-phase region and the derivatives of the molar volume with respect to temperature and pressure. At a system point in the one-phase region, the slope of the isotherm passing through the point is the partial derivative $(\partial p/\partial V_m)_T$. Since the isothermal compressibility is given by $\kappa_T = -(1/V_m)(\partial V_m/\partial p)_T$, we have

$$\kappa_T = -\frac{1}{V_m \times \text{slope of isotherm}} \quad (8.2.9)$$

⁷The relation is called the lever rule by analogy to a stationary mechanical lever, each end of which has the same value of the product of applied force and distance from the fulcrum.

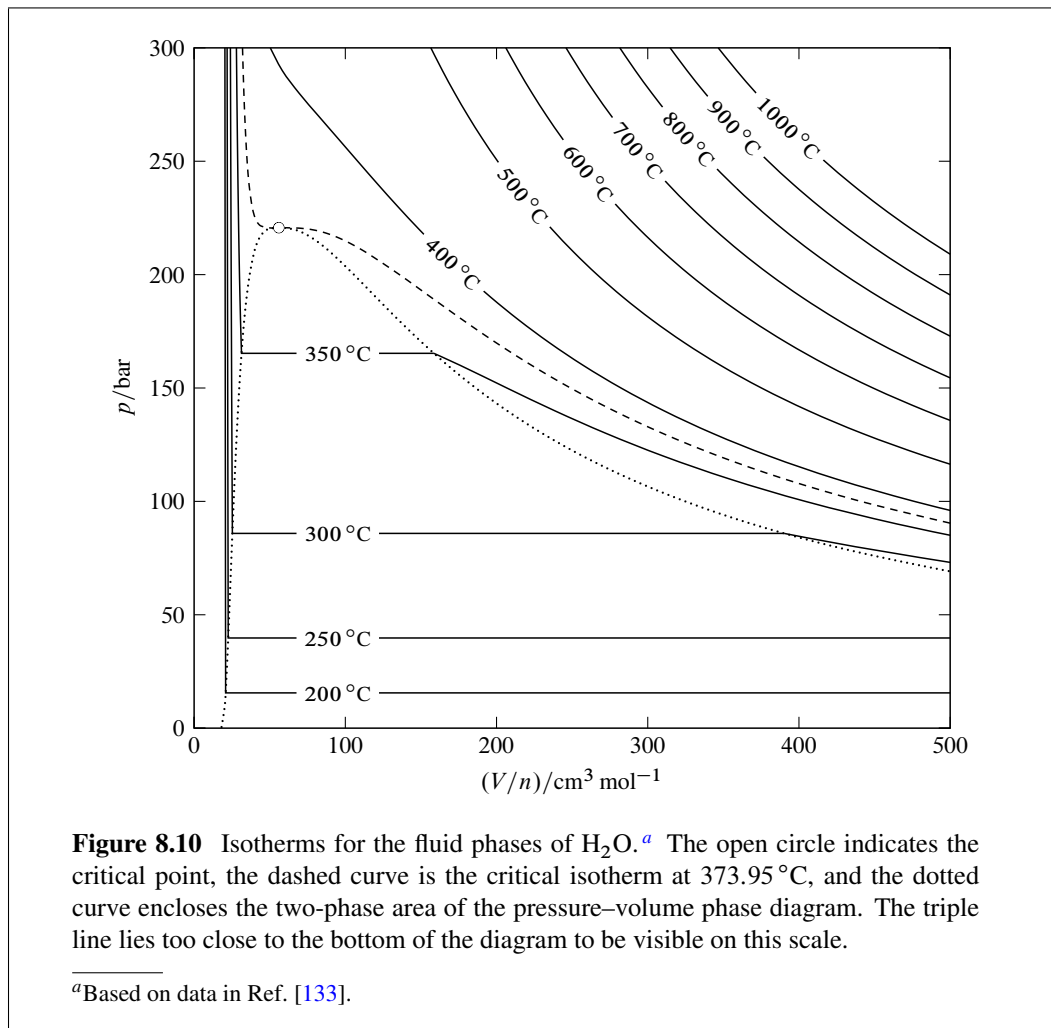

We see from Fig. 8.10 that the slopes of the isotherms are large and negative in the liquid region, smaller and negative in the gas and supercritical fluid regions, and approach zero at the critical point. Accordingly, the isothermal compressibility of the gas and the supercritical fluid is much greater than that of the liquid, approaching infinity at the critical point. The critical opalescence seen in Fig. 8.7 is caused by local density fluctuations, which are large when κ_T is large.

Figure 8.11 on the next page shows isobars for H₂O instead of isotherms. At a system point in the one-phase region, the slope of the isobar passing through the point is the partial derivative $(\partial T/\partial V_m)_p$. The cubic expansion coefficient α is equal to $(1/V_m)(\partial V_m/\partial T)_p$, so we have

$$\alpha = \frac{1}{V_m \times \text{slope of isobar}} \quad (8.2.10)$$

The figure shows that the slopes of the isobars are large and positive in the liquid region, smaller and negative in the gas and supercritical fluid regions, and approach zero at the critical point. Thus the gas and the supercritical fluid have much larger cubic expansion coefficients than the liquid. The value of α approaches infinity at the critical point, meaning

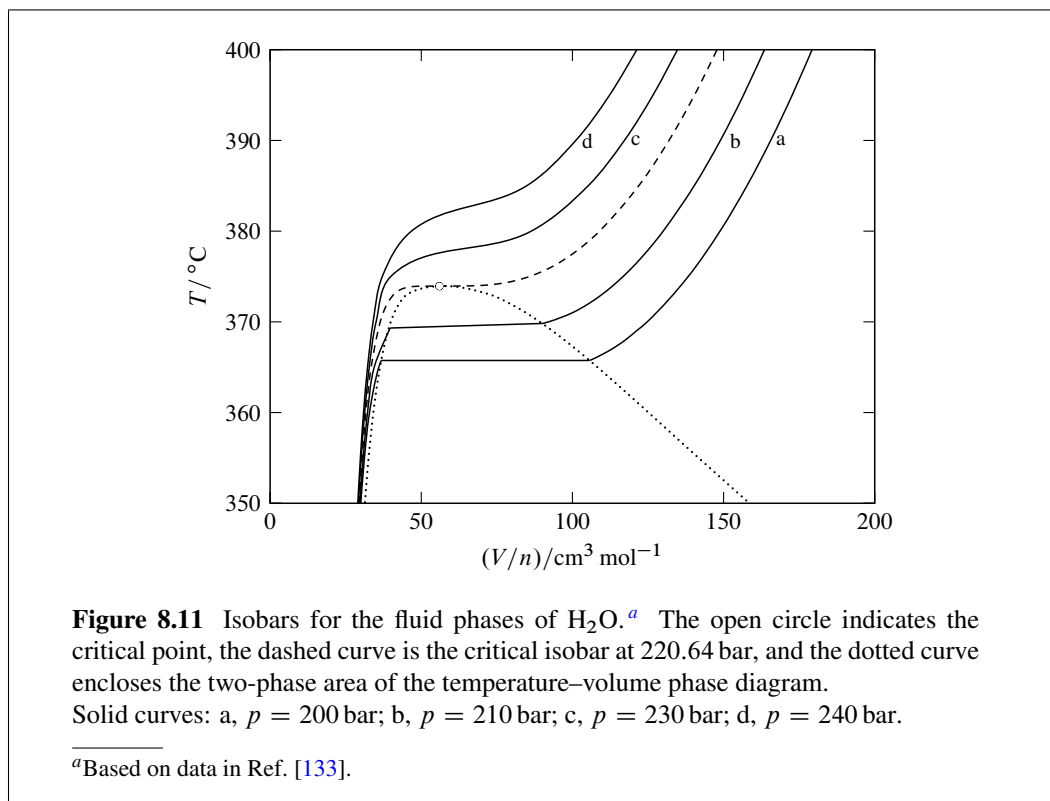

that in the critical region the density distribution is greatly affected by temperature gradients. This may account for the low position of the middle ball in Fig. 8.7(b).

8.3 Phase Transitions

Recall (Sec. 2.2.2) that an equilibrium phase transition of a pure substance is a process in which some or all of the substance is transferred from one coexisting phase to another at constant temperature and pressure.

8.3.1 Molar transition quantities

The quantity $\Delta_{\text{vap}}H$ is the molar enthalpy change for the reversible process in which liquid changes to gas *at a temperature and pressure at which the two phases coexist at equilibrium*. This quantity is called the **molar enthalpy of vaporization**.⁸ Since the pressure is constant during the process, $\Delta_{\text{vap}}H$ is equal to the heat per amount of vaporization (Eq. 5.3.8). Hence, $\Delta_{\text{vap}}H$ is also called the **molar heat of vaporization**.

The first edition of this book used the notation $\Delta_{\text{vap}}H_m$, with subscript m , in order to make it clear that it refers to a *molar* enthalpy of vaporization. The most recent edition of the IUPAC Green Book⁹ recommends that Δ_p be interpreted as an operator symbol:

$\Delta_p \stackrel{\text{def}}{=} \partial/\partial\xi_p$, where “p” is the abbreviation for a process at constant T and p (in

⁸Because $\Delta_{\text{vap}}H$ is an enthalpy *change* per amount of vaporization, it would be more accurate to call it the “molar enthalpy change of vaporization.” ⁹Ref. [36], p. 58.

this case “vap”) and ξ_p is its advancement. Thus $\Delta_{\text{vap}}H$ is the same as $(\partial H/\partial \xi_{\text{vap}})_{T,p}$ where ξ_{vap} is the amount of liquid changed to gas.

Here is a list of symbols for the molar enthalpy changes of various equilibrium phase transitions:

$\Delta_{\text{vap}}H$ molar enthalpy of vaporization (liquid→gas)

$\Delta_{\text{sub}}H$ molar enthalpy of sublimation (solid→gas)

$\Delta_{\text{fus}}H$ molar enthalpy of fusion (solid→liquid)

$\Delta_{\text{trs}}H$ molar enthalpy of a transition between any two phases in general

Molar enthalpies of vaporization, sublimation, and fusion are *positive*. The reverse processes of condensation (gas→liquid), condensation or deposition (gas→solid), and freezing (liquid→solid) have *negative* enthalpy changes.

The subscripts in the list above are also used for other molar transition quantities. Thus, there is the molar entropy of vaporization $\Delta_{\text{vap}}S$, the molar internal energy of sublimation $\Delta_{\text{sub}}U$, and so on.

A molar transition quantity of a pure substance is the change of an extensive property divided by the amount transferred between the phases. For example, when an amount n in a liquid phase is allowed to vaporize to gas at constant T and p , the enthalpy change is $\Delta H = nH_m^g - nH_m^l$ and the molar enthalpy of vaporization is

$$\Delta_{\text{vap}}H = \frac{\Delta H}{n} = H_m^g - H_m^l \quad (8.3.1)$$

(pure substance)

In other words, $\Delta_{\text{vap}}H$ is the enthalpy change per amount vaporized and is also the difference between the molar enthalpies of the two phases.

A molar property of a phase, being intensive, usually depends on two independent intensive variables such as T and p . Despite the fact that $\Delta_{\text{vap}}H$ is the difference of the two molar properties H_m^g and H_m^l , its value depends on only *one* intensive variable, because the two phases are in transfer equilibrium and the system is univariant. Thus, we may treat $\Delta_{\text{vap}}H$ as a function of T only. The same is true of any other molar transition quantity.

The molar Gibbs energy of an equilibrium phase transition, $\Delta_{\text{trs}}G$, is a special case. For the phase transition $\alpha \rightarrow \beta$, we may write an equation analogous to Eq. 8.3.1 and equate the molar Gibbs energy in each phase to a chemical potential (see Eq. 7.8.1):

$$\Delta_{\text{trs}}G = G_m^\beta - G_m^\alpha = \mu^\beta - \mu^\alpha \quad (8.3.2)$$

(pure substance)

But the transition is between two phases at equilibrium, requiring both phases to have the same chemical potential: $\mu^\beta - \mu^\alpha = 0$. Therefore, the molar Gibbs energy of *any* equilibrium phase transition is zero:

$$\Delta_{\text{trs}}G = 0 \quad (8.3.3)$$

(pure substance)

Since the Gibbs energy is defined by $G = H - TS$, in phase α we have $G_m^\alpha = G^\alpha/n^\alpha = H_m^\alpha - TS_m^\alpha$. Similarly, in phase β we have $G_m^\beta = H_m^\beta - TS_m^\beta$. When we substitute these expressions in $\Delta_{\text{trs}}G = G_m^\beta - G_m^\alpha$ (Eq. 8.3.2) and set T equal to the transition temperature

T_{trs} , we obtain

$$\begin{aligned}\Delta_{\text{trs}}G &= (H_{\text{m}}^{\beta} - H_{\text{m}}^{\alpha}) - T_{\text{trs}}(S_{\text{m}}^{\beta} - S_{\text{m}}^{\alpha}) \\ &= \Delta_{\text{trs}}H - T_{\text{trs}}\Delta_{\text{trs}}S\end{aligned}\quad (8.3.4)$$

Then, by setting $\Delta_{\text{trs}}G$ equal to zero, we find the molar entropy and molar enthalpy of the equilibrium phase transition are related by

$$\Delta_{\text{trs}}S = \frac{\Delta_{\text{trs}}H}{T_{\text{trs}}}\quad (8.3.5)$$

(pure substance)

where $\Delta_{\text{trs}}S$ and $\Delta_{\text{trs}}H$ are evaluated at the transition temperature T_{trs} .

We may obtain Eq. 8.3.5 directly from the second law. With the phases in equilibrium, the transition process is reversible. The second law gives $\Delta S = q/T_{\text{trs}} = \Delta H/T_{\text{trs}}$. Dividing by the amount transferred between the phases gives Eq. 8.3.5.

8.3.2 Calorimetric measurement of transition enthalpies

The most precise measurement of the molar enthalpy of an equilibrium phase transition uses electrical work. A known quantity of electrical work is performed on a system containing coexisting phases, in a constant-pressure adiabatic calorimeter, and the resulting amount of substance transferred between the phases is measured. The first law shows that the electrical work $I^2 R_{\text{el}} \Delta t$ equals the heat that would be needed to cause the same change of state. This heat, at constant p , is the enthalpy change of the process.

The method is similar to that used to measure the heat capacity of a phase at constant pressure (Sec. 7.3.2), except that now the temperature remains constant and there is no need to make a correction for the heat capacity of the calorimeter.

8.3.3 Standard molar transition quantities

The *standard* molar enthalpy of vaporization, $\Delta_{\text{vap}}H^{\circ}$, is the enthalpy change when pure liquid in its standard state at a specified temperature changes to gas in its standard state at the same temperature, divided by the amount changed.

Note that the initial state of this process is a real one (the pure liquid at pressure p°), but the final state (the gas behaving ideally at pressure p°) is hypothetical. The liquid and gas are not necessarily in equilibrium with one another at pressure p° and the temperature of interest, and we cannot evaluate $\Delta_{\text{vap}}H^{\circ}$ from a calorimetric measurement with electrical work without further corrections. The same difficulty applies to the evaluation of $\Delta_{\text{sub}}H^{\circ}$. In contrast, $\Delta_{\text{vap}}H$ and $\Delta_{\text{sub}}H$ (without the $^{\circ}$ symbol), as well as $\Delta_{\text{fus}}H^{\circ}$, all refer to reversible transitions between two *real* phases coexisting in equilibrium.

Let X represent one of the thermodynamic potentials or the entropy of a phase. The standard molar transition quantities $\Delta_{\text{vap}}X^{\circ} = X_{\text{m}}^{\circ}(\text{g}) - X_{\text{m}}^{\circ}(\text{l})$ and $\Delta_{\text{sub}}X^{\circ} = X_{\text{m}}^{\circ}(\text{g}) - X_{\text{m}}^{\circ}(\text{s})$ are functions only of T . To evaluate $\Delta_{\text{vap}}X^{\circ}$ or $\Delta_{\text{sub}}X^{\circ}$ at a given temperature, we must calculate the change of X_{m} for a path that connects the standard state of the liquid or solid with that of the gas. The simplest choice of path is one of constant temperature T with the following steps:

1. Isothermal change of the pressure of the liquid or solid, starting with the standard state at pressure p° and ending with the pressure equal to the vapor pressure p_{vap} of the condensed phase at temperature T . The value of ΔX_m in this step can be obtained from an expression in the second column of Table 7.4, or from an approximation in the last column of the table.
2. Reversible vaporization or sublimation to form the real gas at T and p_{vap} . The change of X_m in this step is either $\Delta_{\text{vap}}X$ or $\Delta_{\text{sub}}X$, which can be evaluated experimentally.
3. Isothermal change of the real gas at pressure p_{vap} to the hypothetical ideal gas at pressure p° . Table 7.5 has the relevant formulas relating molar quantities of a real gas to the corresponding standard molar quantities.

The sum of ΔX_m for these three steps is the desired quantity $\Delta_{\text{vap}}X^\circ$ or $\Delta_{\text{sub}}X^\circ$.

8.4 Coexistence Curves

A coexistence curve on a pressure–temperature phase diagram shows the conditions under which two phases can coexist in equilibrium, as explained in Sec. 8.2.2.

8.4.1 Chemical potential surfaces

We may treat the chemical potential μ of a pure substance in a single phase as a function of the independent variables T and p , and represent the function by a three-dimensional surface. Since the condition for equilibrium between two phases of a pure substance is that both phases have the same T , p , and μ , equilibrium in a two-phase system can exist only along the intersection of the surfaces of the two phases as illustrated in Fig. 8.12 on the next page.

The shape of the surface for each phase is determined by the partial derivatives of the chemical potential with respect to temperature and pressure as given by Eqs. 7.8.3 and 7.8.4:

$$\left(\frac{\partial\mu}{\partial T}\right)_p = -S_m \quad \left(\frac{\partial\mu}{\partial p}\right)_T = V_m \quad (8.4.1)$$

Let us explore how μ varies with T at constant p for the different physical states of a substance. The stable phase at each temperature is the one of lowest μ , since transfer of a substance from a higher to a lower μ at constant T and p is spontaneous.

From the relation $(\partial\mu/\partial T)_p = -S_m$, we see that at constant p the slope of μ versus T is negative since molar entropy is always positive. Furthermore, the magnitude of the slope increases on going from solid to liquid and from liquid to gas, because the molar entropies of sublimation and vaporization are positive. This difference in slope is illustrated by the curves for H_2O in Fig. 8.13(a) on page 218. The triple-point pressure of H_2O is 0.0062 bar. At a pressure of 0.03 bar, greater than the triple-point pressure, the curves for solid and liquid intersect at a melting point (point A) and the curves for liquid and gas intersect at a boiling point (point B).

From $(\partial\mu/\partial p)_T = V_m$, we see that a pressure reduction at constant temperature lowers the chemical potential of a phase. The result of a pressure reduction from 0.03 bar to 0.003 bar (below the triple-point pressure of H_2O) is a downward shift of each of the curves of Fig. 8.13(a) by a distance proportional to the molar volume of the phase. The shifts of

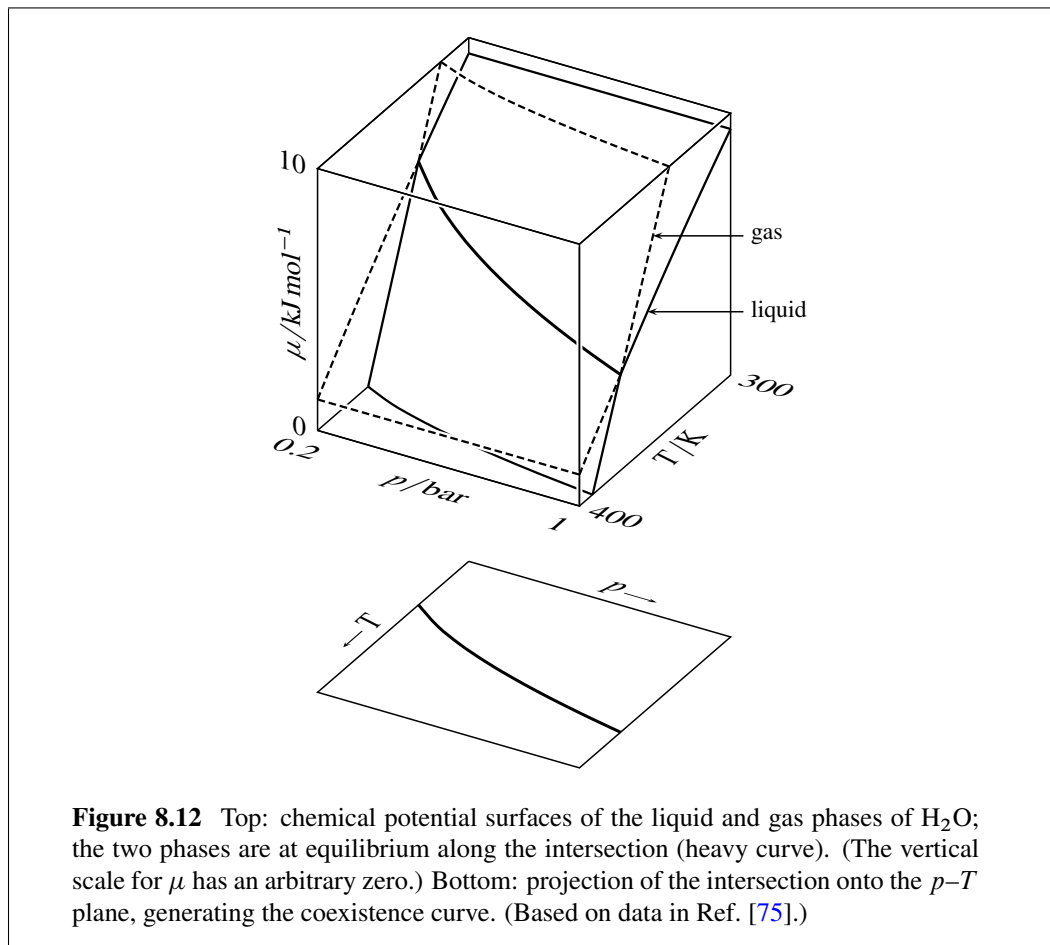

the solid and liquid curves are too small to see ($\Delta\mu$ is only $-0.002 \text{ kJ mol}^{-1}$). Because the gas has a large molar volume, the gas curve shifts substantially to a position where it intersects with the solid curve at a sublimation point (point C). At 0.003 bar, or any other pressure below the triple-point pressure, only a solid–gas equilibrium is possible for H₂O. The liquid phase is not stable at any pressure below the triple-point pressure, as shown by the pressure–temperature phase diagram of H₂O in Fig. 8.13(b).

8.4.2 The Clapeyron equation

If we start with two coexisting phases, α and β , of a pure substance and change the temperature of both phases equally without changing the pressure, the phases will no longer be in equilibrium, because their chemical potentials change unequally. In order for the phases to remain in equilibrium during the temperature change dT of both phases, there must be a certain simultaneous change dp in the pressure of both phases. The changes dT and dp must be such that the chemical potentials of both phases change equally so as to remain equal to one another: $d\mu^\alpha = d\mu^\beta$.

The infinitesimal change of μ in a phase is given by $d\mu = -S_m dT + V_m dp$ (Eq. 7.8.2). Thus, the two phases remain in equilibrium if dT and dp satisfy the relation

$$-S_m^\alpha dT + V_m^\alpha dp = -S_m^\beta dT + V_m^\beta dp \quad (8.4.2)$$

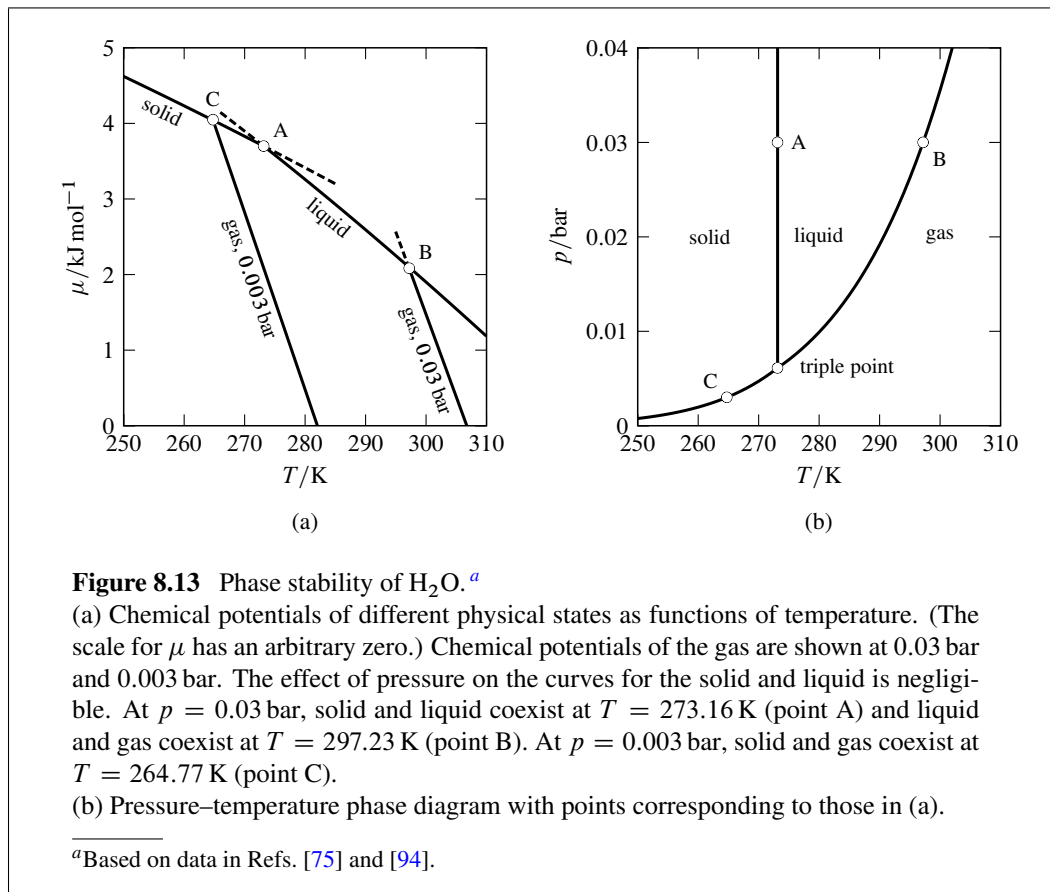

which we rearrange to

$$\frac{dp}{dT} = \frac{S_m^\beta - S_m^\alpha}{V_m^\beta - V_m^\alpha} \quad (8.4.3)$$

or

$$\frac{dp}{dT} = \frac{\Delta_{\text{trs}} S}{\Delta_{\text{trs}} V} \quad (8.4.4)$$

(pure substance)

Equation 8.4.4 is one form of the **Clapeyron equation**, which contains no approximations. We find an alternative form by substituting $\Delta_{\text{trs}} S = \Delta_{\text{trs}} H / T_{\text{trs}}$ (Eq. 8.3.5):

$$\frac{dp}{dT} = \frac{\Delta_{\text{trs}} H}{T \Delta_{\text{trs}} V} \quad (8.4.5)$$

(pure substance)

Equations 8.4.4 and 8.4.5 give the slope of the coexistence curve, dp/dT , as a function of quantities that can be measured. For the sublimation and vaporization processes, both $\Delta_{\text{trs}} H$ and $\Delta_{\text{trs}} V$ are positive. Therefore, according to Eq. 8.4.5, the solid–gas and liquid–gas coexistence curves have positive slopes. For the fusion process, however, $\Delta_{\text{fus}} H$ is positive, but $\Delta_{\text{fus}} V$ may be positive or negative depending on the substance, so that the slope of the solid–liquid coexistence curve may be either positive or negative. The absolute

BIOGRAPHICAL SKETCH

Benoit Paul Émile Clapeyron (1799–1864)

Clapeyron was a French civil and railroad engineer who made important contributions to thermodynamic theory. He was born in Paris, the son of a merchant.

He graduated from the École Polytechnique in 1818, four years after Sadi Carnot's graduation from the same school, and then trained as an engineer at the École de Mines. At this time, the Russian czar asked the French government for engineers to help create a program of civil and military engineering. Clapeyron and his classmate Gabriel Lamé were offered this assignment. They lived in Russia for ten years, teaching pure and applied mathematics in Saint Petersburg and jointly publishing engineering and mathematical papers. In 1831 they returned to France; their liberal political views and the oppression of foreigners by the new czar, Nicholas I, made it impossible for them to remain in Russia.

Back in France, Clapeyron became involved in the construction of the first French passenger railroads and in the design of steam locomotives and metal bridges. He was married with a daughter.

In a paper published in 1834 in the journal of the École Polytechnique, Clapeyron brought attention to the work of Sadi Carnot (page 110), who had died two years before:^a

Among studies which have appeared on the theory of heat I will mention finally a work by S. Carnot, published in 1824, with the title *Reflections on the Motive Power of Fire*. The idea which serves as a basis of his researches seems to me to be both fertile and beyond question; his demonstrations are founded on the *absur-*

dity of the possibility of creating motive power [i.e., work] or heat out of nothing. ... This new method of demonstration seems to me worthy of the attention of theoreticians; it seems to me to be free of all objection ...

Clapeyron's paper used indicator diagrams and calculus for a rigorous proof of Carnot's conclusion that the efficiency of a reversible heat engine depends only on the temperatures of the hot and cold heat reservoirs. However, it retained the erroneous caloric theory of heat. It was not until the appearance of English and German translations of this paper that Clapeyron's analysis enabled Kelvin to define a thermodynamic temperature scale and Clausius to introduce entropy and write the mathematical statement of the second law.

Clapeyron's 1834 paper also derived an expression for the temperature dependence of the vapor pressure of a liquid equivalent to what is now called the Clapeyron equation (Eq. 8.4.5). The paper used a reversible cycle with vaporization at one temperature followed by condensation at an infinitesimally-lower temperature and pressure, and equated the efficiency of this cycle to that of a gas between the same two temperatures. Although the thermodynamic temperature T does not appear as such, it is represented by a temperature-dependent function whose relation to the Celsius scale had to be determined experimentally.^b

Beginning in 1844, Clapeyron taught the course on steam engines at the École Nationale des Ponts et Chaussées near Paris, the oldest French engineering school. In this course, surprisingly, he seldom mentioned his theory of heat engines based on Carnot's work.^c He eventually embraced the equivalence of heat and work established by Joule's experiments.^d

At the time of Clapeyron's death, the railroad entrepreneur Émile Péreire wrote:^e

We were together since 1832. I've never done important business without consulting him, I've never found a judgment more reliable and more honest. His modesty was so great and his character so good that I never knew him to have an enemy.

^aRef. [30]. ^bRef. [185]. ^cRef. [97]. ^dRef. [87]. ^eRef. [87].

value of $\Delta_{\text{fus}}V$ is small, causing the solid–liquid coexistence curve to be relatively steep; see Fig. 8.13(b) for an example.

Most substances *expand* on melting, making the slope of the solid–liquid coexistence curve positive. This is true of carbon dioxide, although in Fig. 8.2(c) on page 203 the curve is so steep that it is difficult to see the slope is positive. Exceptions at ordinary pressures, substances that *contract* on melting, are H_2O , rubidium nitrate, and the elements antimony, bismuth, and gallium.

The phase diagram for H_2O in Fig. 8.4 on page 206 clearly shows that the coexistence curve for ice I and liquid has a negative slope due to ordinary ice being less dense than liquid water. The high-pressure forms of ice are more dense than the liquid, causing the slopes of the other solid–liquid coexistence curves to be positive. The ice VII–ice VIII coexistence curve is vertical, because these two forms of ice have identical crystal structures, except for the orientations of the H_2O molecule; therefore, within experimental uncertainty, the two forms have equal molar volumes.

We may rearrange Eq. 8.4.5 to give the variation of p with T along the coexistence curve:

$$dp = \frac{\Delta_{\text{trs}}H}{\Delta_{\text{trs}}V} \cdot \frac{dT}{T} \quad (8.4.6)$$

Consider the transition from solid to liquid (fusion). Because of the fact that the cubic expansion coefficient and isothermal compressibility of a condensed phase are relatively small, $\Delta_{\text{fus}}V$ is approximately constant for small changes of T and p . If $\Delta_{\text{fus}}H$ is also practically constant, integration of Eq. 8.4.6 yields the relation

$$p_2 - p_1 \approx \frac{\Delta_{\text{fus}}H}{\Delta_{\text{fus}}V} \ln \frac{T_2}{T_1} \quad (8.4.7)$$

or

$$T_2 \approx T_1 \exp \left[\frac{\Delta_{\text{fus}}V(p_2 - p_1)}{\Delta_{\text{fus}}H} \right] \quad (8.4.8)$$

(pure substance)

from which we may estimate the dependence of the melting point on pressure.

8.4.3 The Clausius–Clapeyron equation

When the gas phase of a substance coexists in equilibrium with the liquid or solid phase, and provided T and p are not close to the critical point, the molar volume of the gas is much greater than that of the condensed phase. Thus, we may write for the processes of vaporization and sublimation

$$\Delta_{\text{vap}}V = V_{\text{m}}^{\text{g}} - V_{\text{m}}^{\text{l}} \approx V_{\text{m}}^{\text{g}} \quad \Delta_{\text{sub}}V = V_{\text{m}}^{\text{g}} - V_{\text{m}}^{\text{s}} \approx V_{\text{m}}^{\text{g}} \quad (8.4.9)$$

The further approximation that the gas behaves as an ideal gas, $V_{\text{m}}^{\text{g}} \approx RT/p$, then changes Eq. 8.4.5 to

$$\frac{dp}{dT} \approx \frac{p\Delta_{\text{trs}}H}{RT^2} \quad (8.4.10)$$

(pure substance,
vaporization or sublimation)

Equation 8.4.10 is the **Clausius–Clapeyron equation**. It gives an approximate expression for the slope of a liquid–gas or solid–gas coexistence curve. The expression is not valid for coexisting solid and liquid phases, or for coexisting liquid and gas phases close to the critical point.

At the temperature and pressure of the triple point, it is possible to carry out all three equilibrium phase transitions of fusion, vaporization, and sublimation. When fusion is followed by vaporization, the net change is sublimation. Therefore, the molar transition enthalpies at the triple point are related by

$$\Delta_{\text{fus}}H + \Delta_{\text{vap}}H = \Delta_{\text{sub}}H \quad (8.4.11)$$

Since all three of these transition enthalpies are positive, it follows that $\Delta_{\text{sub}}H$ is greater than $\Delta_{\text{vap}}H$ at the triple point. Therefore, according to Eq. 8.4.10, the slope of the solid–gas coexistence curve at the triple point is slightly greater than the slope of the liquid–gas coexistence curve.

We divide both sides of Eq. 8.4.10 by p° and rearrange to the form

$$\frac{d(p/p^\circ)}{p/p^\circ} \approx \frac{\Delta_{\text{trs}}H}{R} \cdot \frac{dT}{T^2} \quad (8.4.12)$$

Then, using the mathematical identities $d(p/p^\circ)/(p/p^\circ) = d\ln(p/p^\circ)$ and $dT/T^2 = -d(1/T)$, we can write Eq. 8.4.12 in three alternative forms:

$$\frac{d\ln(p/p^\circ)}{dT} \approx \frac{\Delta_{\text{trs}}H}{RT^2} \quad (8.4.13)$$

(pure substance,
vaporization or sublimation)

$$d\ln(p/p^\circ) \approx -\frac{\Delta_{\text{trs}}H}{R} d(1/T) \quad (8.4.14)$$

(pure substance,
vaporization or sublimation)

$$\frac{d\ln(p/p^\circ)}{d(1/T)} \approx -\frac{\Delta_{\text{trs}}H}{R} \quad (8.4.15)$$

(pure substance,
vaporization or sublimation)

Equation 8.4.15 shows that the curve of a plot of $\ln(p/p^\circ)$ versus $1/T$ (where p is the vapor pressure of a pure liquid or solid) has a slope at each temperature equal, usually to a high degree of accuracy, to $-\Delta_{\text{vap}}H/R$ or $-\Delta_{\text{sub}}H/R$ at that temperature. This kind of plot provides an alternative to calorimetry for evaluating molar enthalpies of vaporization and sublimation.

If we use the recommended standard pressure of 1 bar, the ratio p/p° appearing in these equations becomes p/bar . That is, p/p° is simply the numerical value of p when p is expressed in bars. For the purpose of using Eq. 8.4.15 to evaluate $\Delta_{\text{trs}}H$, we can replace p° by any convenient value. Thus, the curves of plots of $\ln(p/\text{bar})$ versus $1/T$, $\ln(p/\text{Pa})$ versus $1/T$, and $\ln(p/\text{Torr})$ versus $1/T$ using the same temperature and pressure data all have the same slope (but different intercepts) and yield the same value of $\Delta_{\text{trs}}H$.

If we assume $\Delta_{\text{vap}}H$ or $\Delta_{\text{sub}}H$ is essentially constant in a temperature range, we may integrate Eq. 8.4.14 from an initial to a final state along the coexistence curve to obtain

$$\ln \frac{p_2}{p_1} \approx -\frac{\Delta_{\text{trs}}H}{R} \left(\frac{1}{T_2} - \frac{1}{T_1} \right) \quad (8.4.16)$$

(pure substance,
vaporization or sublimation)

Equation 8.4.16 allows us to estimate any one of the quantities p_1 , p_2 , T_1 , T_2 , or $\Delta_{\text{trs}}H$, given values of the other four.

PROBLEMS

An underlined problem number or problem-part letter indicates that the numerical answer appears in Appendix I.

- 8.1** Consider the system described in Sec. 8.1.5 containing a spherical liquid droplet of radius r surrounded by pure vapor. Starting with Eq. 8.1.15, find an expression for the total differential of U . Then impose conditions of isolation and show that the equilibrium conditions are $T^l = T^g$, $\mu^g = \mu^l$, and $p^l = p^g + 2\gamma/r$, where γ is the surface tension.
- 8.2** This problem concerns diethyl ether at $T = 298.15$ K. At this temperature, the standard molar entropy of the gas calculated from spectroscopic data is $S_m^\circ(\text{g}) = 342.2 \text{ J K}^{-1} \text{ mol}^{-1}$. The saturation vapor pressure of the liquid at this temperature is 0.6691 bar, and the molar enthalpy of vaporization is $\Delta_{\text{vap}}H = 27.10 \text{ kJ mol}^{-1}$. The second virial coefficient of the gas at this temperature has the value $B = -1.227 \times 10^{-3} \text{ m}^3 \text{ mol}^{-1}$, and its variation with temperature is given by $\text{d}B/\text{d}T = 1.50 \times 10^{-5} \text{ m}^3 \text{ K}^{-1} \text{ mol}^{-1}$.
- (a) Use these data to calculate the standard molar entropy of liquid diethyl ether at 298.15 K. A small pressure change has a negligible effect on the molar entropy of a liquid, so that it is a good approximation to equate $S_m^\circ(\text{l})$ to $S_m(\text{l})$ at the saturation vapor pressure.
- (b) Calculate the standard molar entropy of vaporization and the standard molar enthalpy of vaporization of diethyl ether at 298.15 K. It is a good approximation to equate $H_m^\circ(\text{l})$ to $H_m(\text{l})$ at the saturation vapor pressure.
- 8.3** Explain why the chemical potential surfaces shown in Fig. 8.12 are concave downward; that is, why $(\partial\mu/\partial T)_p$ becomes more negative with increasing T and $(\partial\mu/\partial p)_T$ becomes less positive with increasing p .
- 8.4** Potassium has a standard boiling point of 773 °C and a molar enthalpy of vaporization $\Delta_{\text{vap}}H = 84.9 \text{ kJ mol}^{-1}$. Estimate the saturation vapor pressure of liquid potassium at 400. °C.
- 8.5** Naphthalene has a melting point of 78.2 °C at 1 bar and 81.7 °C at 100 bar. The molar volume change on melting is $\Delta_{\text{fus}}V = 0.019 \text{ cm}^3 \text{ mol}^{-1}$. Calculate the molar enthalpy of fusion to two significant figures.
- 8.6** The dependence of the vapor pressure of a liquid on temperature, over a limited temperature range, is often represented by the *Antoine equation*, $\log_{10}(p/\text{Torr}) = A - B/(t + C)$, where t is the Celsius temperature and A , B , and C are constants determined by experiment. A variation of this equation, using a natural logarithm and the thermodynamic temperature, is

$$\ln(p/\text{bar}) = a - \frac{b}{T + c}$$

The vapor pressure of liquid benzene at temperatures close to 298 K is adequately represented by the preceding equation with the following values of the constants:

$$a = 9.25092 \quad b = 2771.233 \text{ K} \quad c = -53.262 \text{ K}$$

- (a) Find the standard boiling point of benzene.
- (b) Use the Clausius–Clapeyron equation to evaluate the molar enthalpy of vaporization of benzene at 298.15 K.
- 8.7** At a pressure of one atmosphere, water and steam are in equilibrium at 99.97 °C (the normal boiling point of water). At this pressure and temperature, the water density is 0.958 g cm^{-3} , the steam density is $5.98 \times 10^{-4} \text{ g cm}^{-3}$, and the molar enthalpy of vaporization is $40.66 \text{ kJ mol}^{-1}$.
- (a) Use the Clapeyron equation to calculate the slope $\text{d}p/\text{d}T$ of the liquid–gas coexistence curve at this point.

- (b) Repeat the calculation using the Clausius–Clapeyron equation.
 (c) Use your results to estimate the standard boiling point of water. (Note: The experimental value is 99.61 °C.)

8.8 At the standard pressure of 1 bar, liquid and gaseous H₂O coexist in equilibrium at 372.76 K, the standard boiling point of water.

- (a) Do you expect the standard molar enthalpy of vaporization to have the same value as the molar enthalpy of vaporization at this temperature? Explain.
 (b) The molar enthalpy of vaporization at 372.76 K has the value $\Delta_{\text{vap}}H = 40.67 \text{ kJ mol}^{-1}$. Estimate the value of $\Delta_{\text{vap}}H^\circ$ at this temperature with the help of Table 7.5 and the following data for the second virial coefficient of gaseous H₂O at 372.76 K:

$$B = -4.60 \times 10^{-4} \text{ m}^3 \text{ mol}^{-1} \quad dB/dT = 3.4 \times 10^{-6} \text{ m}^3 \text{ K}^{-1} \text{ mol}^{-1}$$

- (c) Would you expect the values of $\Delta_{\text{fus}}H$ and $\Delta_{\text{fus}}H^\circ$ to be equal at the standard freezing point of water? Explain.

8.9 The standard boiling point of H₂O is 99.61 °C. The molar enthalpy of vaporization at this temperature is $\Delta_{\text{vap}}H = 40.67 \text{ kJ mol}^{-1}$. The molar heat capacity of the liquid at temperatures close to this value is given by

$$C_{p,m} = a + b(t - c)$$

where t is the Celsius temperature and the constants have the values

$$a = 75.94 \text{ J K}^{-1} \text{ mol}^{-1} \quad b = 0.022 \text{ J K}^{-2} \text{ mol}^{-1} \quad c = 99.61 \text{ }^\circ\text{C}$$

Suppose 100.00 mol of liquid H₂O is placed in a container maintained at a constant pressure of 1 bar, and is carefully heated to a temperature 5.00 °C above the standard boiling point, resulting in an unstable phase of superheated water. If the container is enclosed with an adiabatic boundary and the system subsequently changes spontaneously to an equilibrium state, what amount of water will vaporize? (Hint: The temperature will drop to the standard boiling point, and the enthalpy change will be zero.)

MIXTURES

A homogeneous mixture is a phase containing more than one substance. This chapter discusses composition variables and partial molar quantities of mixtures in which no chemical reaction is occurring. The ideal mixture is defined. Chemical potentials, activity coefficients, and activities of individual substances in both ideal and nonideal mixtures are discussed.

Except for the use of fugacities to determine activity coefficients in condensed phases, a discussion of phase equilibria involving mixtures will be postponed to Chap. 13.

9.1 Composition Variables

A **composition variable** is an intensive property that indicates the relative amount of a particular species or substance in a phase.

9.1.1 Species and substances

We sometimes need to make a distinction between a species and a substance. A **species** is any entity of definite elemental composition and charge and can be described by a chemical formula, such as H_2O , H_3O^+ , NaCl , or Na^+ . A **substance** is a species that can be prepared in a pure state (e.g., N_2 and NaCl). Since we cannot prepare a macroscopic amount of a single kind of ion by itself, a charged species such as H_3O^+ or Na^+ is not a substance. Chap. 10 will discuss the special features of mixtures containing charged species.

9.1.2 Mixtures in general

The **mole fraction** of species i is defined by

$$x_i \stackrel{\text{def}}{=} \frac{n_i}{\sum_j n_j} \quad \text{or} \quad y_i \stackrel{\text{def}}{=} \frac{n_i}{\sum_j n_j} \quad (9.1.1) \quad (P=1)$$

where n_i is the amount of species i and the sum is taken over all species in the mixture. The symbol x_i is used for a mixture in general, and y_i is used when the mixture is a gas.

The **mass fraction**, or weight fraction, of species i is defined by

$$w_i \stackrel{\text{def}}{=} \frac{m(i)}{m} = \frac{n_i M_i}{\sum_j n_j M_j} \quad (9.1.2) \quad (P=1)$$

where $m(i)$ is the mass of species i and m is the total mass.

The **concentration**, or molarity, of species i in a mixture is defined by

$$c_i \stackrel{\text{def}}{=} \frac{n_i}{V} \quad (9.1.3)$$

($P=1$)

The symbol M is often used to stand for units of mol L^{-1} , or mol dm^{-3} . Thus, a concentration of $0.5 M$ is 0.5 moles per liter, or 0.5 molar.

Concentration is sometimes called “amount concentration” or “molar concentration” to avoid confusion with number concentration (the number of *particles* per unit volume). An alternative notation for c_A is $[A]$.

A **binary mixture** is a mixture of *two* substances.

9.1.3 Solutions

A **solution**, strictly speaking, is a mixture in which one substance, the **solvent**, is treated in a special way. Each of the other species comprising the mixture is then a **solute**. The solvent is denoted by A and the solute species by B , C , and so on.¹ Although in principle a solution can be a gas mixture, in this section we will consider only liquid and solid solutions.

We can prepare a solution of varying composition by gradually mixing one or more solutes with the solvent so as to continuously increase the solute mole fractions. During this mixing process, the physical state (liquid or solid) of the solution remains the same as that of the pure solvent. When the sum of the solute mole fractions is small compared to x_A (i.e., x_A is close to unity), the solution is called *dilute*. As the solute mole fractions increase, we say the solution becomes more *concentrated*.

Mole fraction, mass fraction, and concentration can be used as composition variables for both solvent and solute, just as they are for mixtures in general. A fourth composition variable, molality, is often used for a solute. The **molality** of solute species B is defined by

$$m_B \stackrel{\text{def}}{=} \frac{n_B}{m(A)} \quad (9.1.4)$$

(solution)

where $m(A) = n_A M_A$ is the mass of solvent. The symbol m is sometimes used to stand for units of mol kg^{-1} , although this should be discouraged because m is also the symbol for meter. For example, a solute molality of $0.6 m$ is 0.6 moles of solute per kilogram of solvent, or 0.6 molal.

9.1.4 Binary solutions

We may write simplified equations for a binary solution of two substances, solvent A and solute B . Equations 9.1.1–9.1.4 become

$$x_B = \frac{n_B}{n_A + n_B} \quad (9.1.5)$$

(binary solution)

¹Some chemists denote the solvent by subscript 1 and use 2, 3, and so on for solutes.

$$w_B = \frac{n_B M_B}{n_A M_A + n_B M_B} \quad (9.1.6)$$

(binary solution)

$$c_B = \frac{n_B}{V} = \frac{n_B \rho}{n_A M_A + n_B M_B} \quad (9.1.7)$$

(binary solution)

$$m_B = \frac{n_B}{n_A M_A} \quad (9.1.8)$$

(binary solution)

The right sides of Eqs. 9.1.5–9.1.8 express the solute composition variables in terms of the amounts and molar masses of the solvent and solute and the density ρ of the solution.

To be able to relate the values of these composition variables to one another, we solve each equation for n_B and divide by n_A to obtain an expression for the mole ratio n_B/n_A :

$$\text{from Eq. 9.1.5} \quad \frac{n_B}{n_A} = \frac{x_B}{1 - x_B} \quad (9.1.9)$$

(binary solution)

$$\text{from Eq. 9.1.6} \quad \frac{n_B}{n_A} = \frac{M_A w_B}{M_B (1 - w_B)} \quad (9.1.10)$$

(binary solution)

$$\text{from Eq. 9.1.7} \quad \frac{n_B}{n_A} = \frac{M_A c_B}{\rho - M_B c_B} \quad (9.1.11)$$

(binary solution)

$$\text{from Eq. 9.1.8} \quad \frac{n_B}{n_A} = M_A m_B \quad (9.1.12)$$

(binary solution)

These expressions for n_B/n_A allow us to find one composition variable as a function of another. For example, to find molality as a function of concentration, we equate the expressions for n_B/n_A on the right sides of Eqs. 9.1.11 and 9.1.12 and solve for m_B to obtain

$$m_B = \frac{c_B}{\rho - M_B c_B} \quad (9.1.13)$$

A binary solution becomes more dilute as any of the solute composition variables becomes smaller. In the limit of infinite dilution, the expressions for n_B/n_A become:

$$\begin{aligned} \frac{n_B}{n_A} &= x_B \\ &= \frac{M_A}{M_B} w_B \\ &= \frac{M_A}{\rho_A^*} c_B = V_{m,A}^* c_B \\ &= M_A m_B \end{aligned} \quad (9.1.14)$$

(binary solution at infinite dilution)

where a superscript asterisk (*) denotes a pure phase. We see that, in the limit of infinite dilution, the composition variables x_B , w_B , c_B , and m_B are proportional to one another. These expressions are also valid for solute B in a *multisolute* solution in which *each* solute is very dilute; that is, in the limit $x_A \rightarrow 1$.

The rule of thumb that the molarity and molality values of a dilute aqueous solution are approximately equal is explained by the relation $M_A c_B / \rho_A^* = M_A m_B$ (from Eq. 9.1.14), or $c_B / \rho_A^* = m_B$, and the fact that the density ρ_A^* of water is approximately 1 kg L^{-1} . Hence, if the solvent is water and the solution is dilute, the numerical value of c_B expressed in mol L^{-1} is approximately equal to the numerical value of m_B expressed in mol kg^{-1} .

9.1.5 The composition of a mixture

We can describe the composition of a phase with the amounts of each species, or with any of the composition variables defined earlier: mole fraction, mass fraction, concentration, or molality. If we use mole fractions or mass fractions to describe the composition, we need the values for all but one of the species, since the sum of all fractions is unity.

Other composition variables are sometimes used, such as volume fraction, mole ratio, and mole percent. To describe the composition of a gas mixture, partial pressures can be used (Sec. 9.3.1).

When the composition of a mixture is said to be *fixed* or *constant* during changes of temperature, pressure, or volume, this means there is no change in the relative *amounts* or *masses* of the various species. A mixture of fixed composition has fixed values of mole fractions, mass fractions, and molalities, but not necessarily of concentrations and partial pressures. Concentrations will change if the volume changes, and partial pressures in a gas mixture will change if the pressure changes.

9.2 Partial Molar Quantities

The symbol X_i , where X is an extensive property of a homogeneous mixture and the subscript i identifies a constituent species of the mixture, denotes the **partial molar quantity** of species i defined by

$$X_i \stackrel{\text{def}}{=} \left(\frac{\partial X}{\partial n_i} \right)_{T, p, n_{j \neq i}} \quad (9.2.1)$$

(mixture)

This is the rate at which property X changes with the amount of species i added to the mixture as the temperature, the pressure, and the amounts of all other species are kept constant. A partial molar quantity is an *intensive* state function. Its value depends on the temperature, pressure, and composition of the mixture.

Keep in mind that as a practical matter, a macroscopic amount of a charged species (i.e., an ion) cannot be added by itself to a phase because of the huge electric charge that would result. Thus if species i is charged, X_i as defined by Eq. 9.2.1 is a theoretical concept whose value cannot be determined experimentally.

An older notation for a partial molar quantity uses an overbar: \bar{X}_i . The notation X_i' was suggested in the first edition of the IUPAC Green Book,² but is not mentioned in later editions.

²Ref. [126], p. 44.

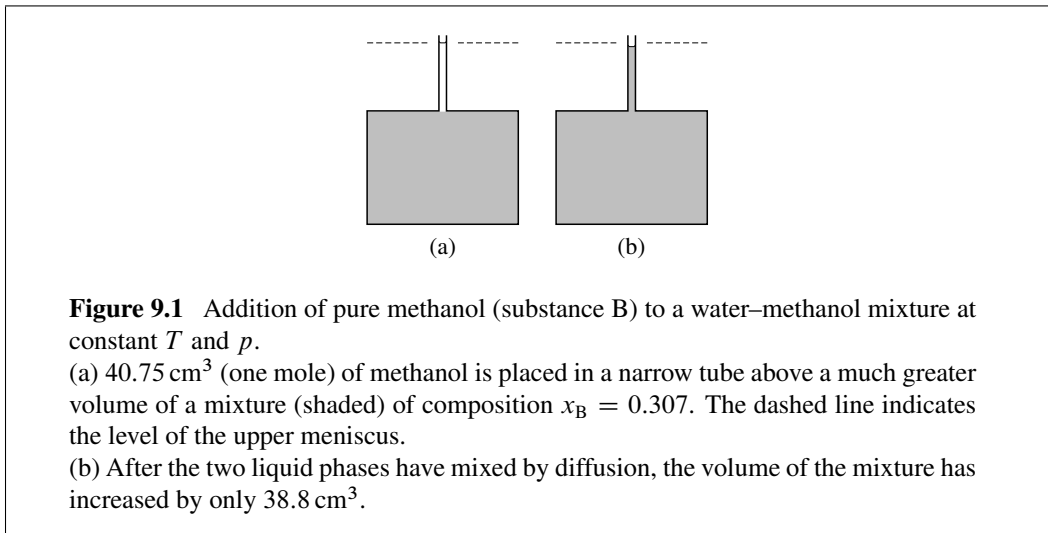

9.2.1 Partial molar volume

In order to gain insight into the significance of a partial molar quantity as defined by Eq. 9.2.1, let us first apply the concept to the *volume* of an open single-phase system. Volume has the advantage for our example of being an extensive property that is easily visualized. Let the system be a binary mixture of water (substance A) and methanol (substance B), two liquids that mix in all proportions. The partial molar volume of the methanol, then, is the rate at which the system volume changes with the amount of methanol added to the mixture at constant temperature and pressure: $V_B = (\partial V / \partial n_B)_{T,p,n_A}$.

At 25°C and 1 bar, the molar volume of pure water is $V_{m,A}^* = 18.07 \text{ cm}^3 \text{ mol}^{-1}$ and that of pure methanol is $V_{m,B}^* = 40.75 \text{ cm}^3 \text{ mol}^{-1}$. If we mix 100.0 cm^3 of water at 25°C with 100.0 cm^3 of methanol at 25°C , we find the volume of the resulting mixture at 25°C is not the sum of the separate volumes, 200.0 cm^3 , but rather the slightly smaller value 193.1 cm^3 . The difference is due to new intermolecular interactions in the mixture compared to the pure liquids.

Let us calculate the mole fraction composition of this mixture:

$$n_A = \frac{V_A^*}{V_{m,A}^*} = \frac{100.0 \text{ cm}^3}{18.07 \text{ cm}^3 \text{ mol}^{-1}} = 5.53 \text{ mol} \quad (9.2.2)$$

$$n_B = \frac{V_B^*}{V_{m,B}^*} = \frac{100.0 \text{ cm}^3}{40.75 \text{ cm}^3 \text{ mol}^{-1}} = 2.45 \text{ mol} \quad (9.2.3)$$

$$x_B = \frac{n_B}{n_A + n_B} = \frac{2.45 \text{ mol}}{5.53 \text{ mol} + 2.45 \text{ mol}} = 0.307 \quad (9.2.4)$$

Now suppose we prepare a large volume of a mixture of this composition ($x_B = 0.307$) and add an additional 40.75 cm^3 (one mole) of pure methanol, as shown in Fig. 9.1(a). If the initial volume of the mixture at 25°C was $10,000.0 \text{ cm}^3$, we find the volume of the new mixture at the same temperature is $10,038.8 \text{ cm}^3$, an increase of 38.8 cm^3 —see Fig. 9.1(b). The amount of methanol added is not infinitesimal, but it is small enough compared to the amount of initial mixture to cause very little change in the mixture composition: x_B

increases by only 0.5%. Treating the mixture as an open system, we see that the addition of one mole of methanol to the system at constant T , p , and n_A causes the system volume to increase by 38.8 cm^3 . To a good approximation, then, the partial molar volume of methanol in the mixture, $V_B = (\partial V / \partial n_B)_{T,p,n_A}$, is given by $\Delta V / \Delta n_B = 38.8 \text{ cm}^3 \text{ mol}^{-1}$.

The volume of the mixture to which we add the methanol does not matter as long as it is large. We would have observed practically the same volume increase, 38.8 cm^3 , if we had mixed one mole of pure methanol with $100,000.0 \text{ cm}^3$ of the mixture instead of only $10,000.0 \text{ cm}^3$.

Thus, we may interpret the partial molar volume of B as the volume change per amount of B added at constant T and p when B is mixed with such a large volume of mixture that the composition is not appreciably affected. We may also interpret the partial molar volume as the volume change per amount when an infinitesimal amount is mixed with a finite volume of mixture.

The partial molar volume of B is an intensive property that is a function of the composition of the mixture, as well as of T and p . The limiting value of V_B as x_B approaches 1 (pure B) is $V_{m,B}^*$, the molar volume of pure B. We can see this by writing $V = n_B V_{m,B}^*$ for pure B, giving us $V_B(x_B=1) = (\partial n_B V_{m,B}^* / \partial n_B)_{T,p,n_A} = V_{m,B}^*$.

If the mixture is a binary mixture of A and B, and x_B is small, we may treat the mixture as a dilute solution of solvent A and solute B. As x_B approaches 0 in this solution, V_B approaches a certain limiting value that is the volume increase per amount of B mixed with a large amount of pure A. In the resulting mixture, each solute molecule is surrounded only by solvent molecules. We denote this limiting value of V_B by V_B^∞ , the partial molar volume of solute B at infinite dilution.

It is possible for a partial molar volume to be *negative*. Magnesium sulfate, in aqueous solutions of molality less than 0.07 mol kg^{-1} , has a negative partial molar volume. Physically, this means that when a small amount of crystalline MgSO_4 dissolves at constant temperature in water, the liquid phase contracts. This unusual behavior is due to strong attractive water-ion interactions.

9.2.2 The total differential of the volume in an open system

Consider an open single-phase system consisting of a mixture of nonreacting substances. How many independent variables does this system have?

We can prepare the mixture with various amounts of each substance, and we are able to adjust the temperature and pressure to whatever values we wish (within certain limits that prevent the formation of a second phase). Each choice of temperature, pressure, and amounts results in a definite value of every other property, such as volume, density, and mole fraction composition. Thus, an open single-phase system of C substances has $2 + C$ independent variables.³

For a binary mixture ($C = 2$), the number of independent variables is four. We may choose these variables to be T , p , n_A , and n_B , and write the total differential of V in the

³ C in this kind of system is actually the number of *components*. The number of components is usually the same as the number of substances, but is less if certain constraints exist, such as reaction equilibrium or a fixed mixture composition. The general meaning of C will be discussed in Sec. 13.1.

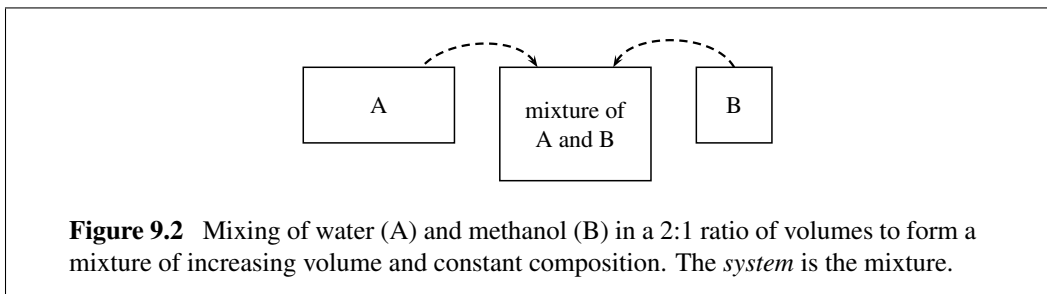

general form

$$dV = \left(\frac{\partial V}{\partial T}\right)_{p,n_A,n_B} dT + \left(\frac{\partial V}{\partial p}\right)_{T,n_A,n_B} dp + \left(\frac{\partial V}{\partial n_A}\right)_{T,p,n_B} dn_A + \left(\frac{\partial V}{\partial n_B}\right)_{T,p,n_A} dn_B \quad (9.2.5)$$

(binary mixture)

We know the first two partial derivatives on the right side are given by⁴

$$\left(\frac{\partial V}{\partial T}\right)_{p,n_A,n_B} = \alpha V \quad \left(\frac{\partial V}{\partial p}\right)_{T,n_A,n_B} = -\kappa_T V \quad (9.2.6)$$

We identify the last two partial derivatives on the right side of Eq. 9.2.5 as the partial molar volumes V_A and V_B . Thus, we may write the total differential of V for this open system in the compact form

$$dV = \alpha V dT - \kappa_T V dp + V_A dn_A + V_B dn_B \quad (9.2.7)$$

(binary mixture)

If we compare this equation with the total differential of V for a one-component *closed* system, $dV = \alpha V dT - \kappa_T V dp$ (Eq. 7.1.6), we see that an additional term is required for each constituent of the mixture to allow the system to be open and the composition to vary.

When T and p are held constant, Eq. 9.2.7 becomes

$$dV = V_A dn_A + V_B dn_B \quad (9.2.8)$$

(binary mixture,
constant T and p)

We obtain an important relation between the mixture volume and the partial molar volumes by imagining the following process. Suppose we continuously pour pure water and pure methanol at constant but not necessarily equal volume rates into a stirred, thermostated container to form a mixture of increasing volume and constant composition, as shown schematically in Fig. 9.2. If this mixture remains at constant T and p as it is formed, none of its intensive properties change during the process, and the partial molar volumes V_A and V_B remain constant. Under these conditions, we can integrate Eq. 9.2.8 to obtain the **additivity**

⁴See Eqs. 7.1.1 and 7.1.2, which are for closed systems.

rule for volume:⁵

$$V = V_A n_A + V_B n_B \quad (9.2.9)$$

(binary mixture)

This equation allows us to calculate the mixture volume from the amounts of the constituents and the appropriate partial molar volumes for the particular temperature, pressure, and composition.

For example, given that the partial molar volumes in a water–methanol mixture of composition $x_B = 0.307$ are $V_A = 17.74 \text{ cm}^3 \text{ mol}^{-1}$ and $V_B = 38.76 \text{ cm}^3 \text{ mol}^{-1}$, we calculate the volume of the water–methanol mixture described at the beginning of Sec. 9.2.1 as follows:

$$\begin{aligned} V &= (17.74 \text{ cm}^3 \text{ mol}^{-1})(5.53 \text{ mol}) + (38.76 \text{ cm}^3 \text{ mol}^{-1})(2.45 \text{ mol}) \\ &= 193.1 \text{ cm}^3 \end{aligned} \quad (9.2.10)$$

We can differentiate Eq. 9.2.9 to obtain a general expression for dV under conditions of constant T and p :

$$dV = V_A dn_A + V_B dn_B + n_A dV_A + n_B dV_B \quad (9.2.11)$$

But this expression for dV is consistent with Eq. 9.2.8 only if the sum of the last two terms on the right is zero:

$$n_A dV_A + n_B dV_B = 0 \quad (9.2.12)$$

(binary mixture,
constant T and p)

Equation 9.2.12 is the **Gibbs–Duhem equation** for a binary mixture, applied to partial molar volumes. (Section 9.2.4 will give a general version of this equation.) Dividing both sides of the equation by $n_A + n_B$ gives the equivalent form

$$x_A dV_A + x_B dV_B = 0 \quad (9.2.13)$$

(binary mixture,
constant T and p)

Equation 9.2.12 shows that changes in the values of V_A and V_B are related when the composition changes at constant T and p . If we rearrange the equation to the form

$$dV_A = -\frac{n_B}{n_A} dV_B \quad (9.2.14)$$

(binary mixture,
constant T and p)

we see that a composition change that *increases* V_B (so that dV_B is positive) must make V_A *decrease*.

9.2.3 Evaluation of partial molar volumes in binary mixtures

The partial molar volumes V_A and V_B in a binary mixture can be evaluated by the **method of intercepts**. To use this method, we plot experimental values of the quantity V/n (where n is $n_A + n_B$) versus the mole fraction x_B . V/n is called the *mean molar volume*.

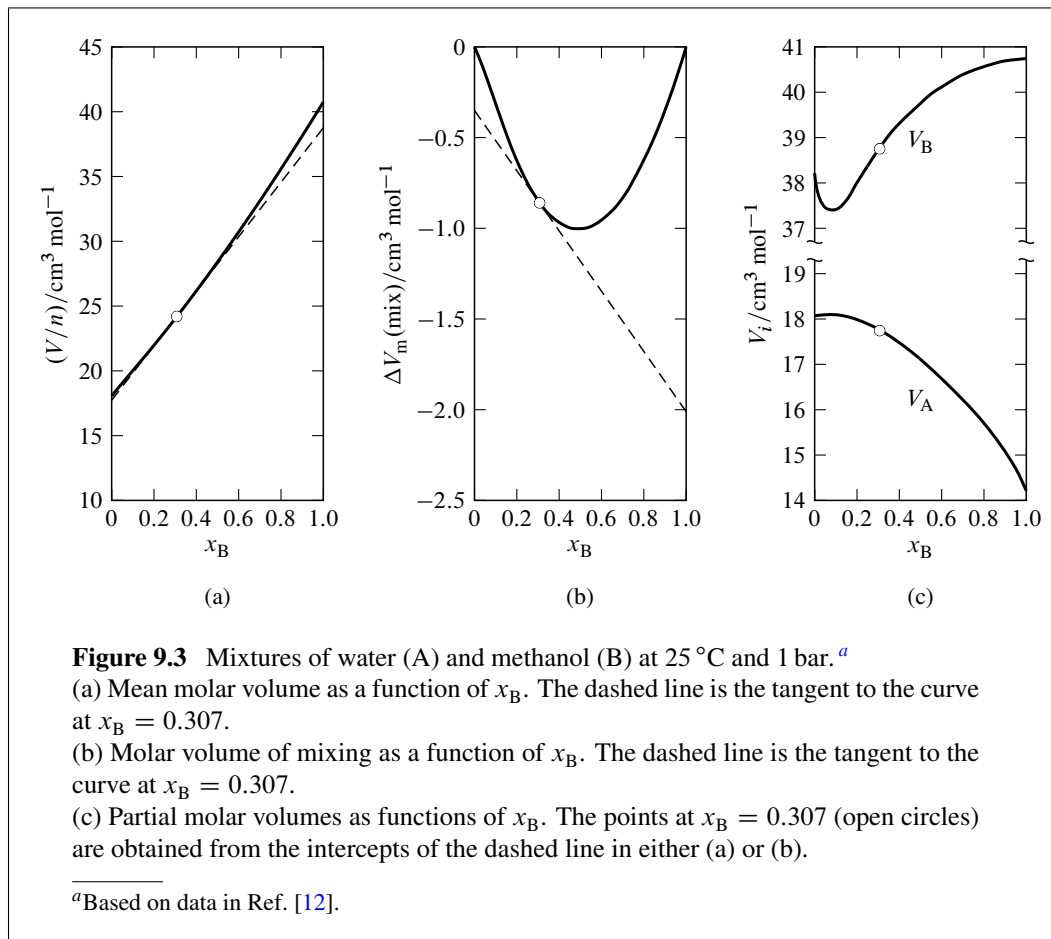

See Fig. 9.3(a) for an example. In this figure, the tangent to the curve drawn at the point on the curve at the composition of interest (the composition used as an illustration in Sec. 9.2.1) intercepts the vertical line where x_B equals 0 at $V/n = V_A = 17.7 \text{ cm}^3 \text{ mol}^{-1}$, and intercepts the vertical line where x_B equals 1 at $V/n = V_B = 38.8 \text{ cm}^3 \text{ mol}^{-1}$.

To derive this property of a tangent line for the plot of V/n versus x_B , we use Eq. 9.2.9 to write

$$\begin{aligned} (V/n) &= \frac{V_A n_A + V_B n_B}{n} = V_A x_A + V_B x_B \\ &= V_A(1 - x_B) + V_B x_B = (V_B - V_A)x_B + V_A \end{aligned} \quad (9.2.15)$$

When we differentiate this expression for V/n with respect to x_B , keeping in mind that

⁵The equation is an example of the result of applying Euler's theorem on homogeneous functions to V treated as a function of n_A and n_B .

V_A and V_B are functions of x_B , we obtain

$$\begin{aligned} \frac{d(V/n)}{dx_B} &= \frac{d[(V_B - V_A)x_B + V_A]}{dx_B} \\ &= V_B - V_A + \left(\frac{dV_B}{dx_B} - \frac{dV_A}{dx_B} \right) x_B + \frac{dV_A}{dx_B} \\ &= V_B - V_A + \left(\frac{dV_A}{dx_B} \right) (1 - x_B) + \left(\frac{dV_B}{dx_B} \right) x_B \\ &= V_B - V_A + \left(\frac{dV_A}{dx_B} \right) x_A + \left(\frac{dV_B}{dx_B} \right) x_B \end{aligned} \quad (9.2.16)$$

The differentials dV_A and dV_B are related to one another by the Gibbs–Duhem equation (Eq. 9.2.13): $x_A dV_A + x_B dV_B = 0$. We divide both sides of this equation by dx_B to obtain

$$\left(\frac{dV_A}{dx_B} \right) x_A + \left(\frac{dV_B}{dx_B} \right) x_B = 0 \quad (9.2.17)$$

and substitute in Eq. 9.2.16 to obtain

$$\frac{d(V/n)}{dx_B} = V_B - V_A \quad (9.2.18)$$

Let the partial molar volumes of the constituents of a binary mixture of arbitrary composition x'_B be V'_A and V'_B . Equation 9.2.15 shows that the value of V/n at the point on the curve of V/n versus x_B where the composition is x'_B is $(V'_B - V'_A)x'_B + V'_A$. Equation 9.2.18 shows that the tangent to the curve at this point has a slope of $V'_B - V'_A$. The equation of the line that passes through this point and has this slope, and thus is the tangent to the curve at this point, is $y = (V'_B - V'_A)x_B + V'_A$, where y is the vertical ordinate on the plot of (V/n) versus x_B . The line has intercepts $y = V'_A$ at $x_B = 0$ and $y = V'_B$ at $x_B = 1$.

A variant of the method of intercepts is to plot the molar integral volume of mixing given by

$$\Delta V_m(\text{mix}) = \frac{\Delta V(\text{mix})}{n} = \frac{V - n_A V_{m,A}^* - n_B V_{m,B}^*}{n} \quad (9.2.19)$$

versus x_B , as illustrated in Fig. 9.3(b). $\Delta V(\text{mix})$ is the integral volume of mixing—the volume change at constant T and p when solvent and solute are mixed to form a mixture of volume V and total amount n (see Sec. 11.1.1). The tangent to the curve at the composition of interest has intercepts $V_A - V_{m,A}^*$ at $x_B = 0$ and $V_B - V_{m,B}^*$ at $x_B = 1$.

To see this, we write

$$\begin{aligned} \Delta V_m(\text{mix}) &= (V/n) - x_A V_{m,A}^* - x_B V_{m,B}^* \\ &= (V/n) - (1 - x_B) V_{m,A}^* - x_B V_{m,B}^* \end{aligned} \quad (9.2.20)$$

We make the substitution $(V/n) = (V_B - V_A)x_B + V_A$ from Eq. 9.2.15 and rearrange:

$$\Delta V_m(\text{mix}) = [(V_B - V_{m,B}^*) - (V_A - V_{m,A}^*)] x_B + (V_A - V_{m,A}^*) \quad (9.2.21)$$

Differentiation with respect to x_B yields

$$\begin{aligned}
 \frac{d\Delta V_m(\text{mix})}{dx_B} &= (V_B - V_{m,B}^*) - (V_A - V_{m,A}^*) + \left(\frac{dV_B}{dx_B} - \frac{dV_A}{dx_B}\right)x_B + \frac{dV_A}{dx_B} \\
 &= (V_B - V_{m,B}^*) - (V_A - V_{m,A}^*) + \left(\frac{dV_A}{dx_B}\right)(1 - x_B) + \left(\frac{dV_B}{dx_B}\right)x_B \\
 &= (V_B - V_{m,B}^*) - (V_A - V_{m,A}^*) + \left(\frac{dV_A}{dx_B}\right)x_A + \left(\frac{dV_B}{dx_B}\right)x_B
 \end{aligned}
 \tag{9.2.22}$$

With a substitution from Eq. 9.2.17, this becomes

$$\frac{d\Delta V_m(\text{mix})}{dx_B} = (V_B - V_{m,B}^*) - (V_A - V_{m,A}^*)
 \tag{9.2.23}$$

Equations 9.2.21 and 9.2.23 are analogous to Eqs. 9.2.15 and 9.2.18, with V/n replaced by $\Delta V_m(\text{mix})$, V_A by $(V_A - V_{m,A}^*)$, and V_B by $(V_B - V_{m,B}^*)$. Using the same reasoning as for a plot of V/n versus x_B , we find the intercepts of the tangent to a point on the curve of $\Delta V_m(\text{mix})$ versus x_B are at $V_A - V_{m,A}^*$ and $V_B - V_{m,B}^*$.

Figure 9.3 shows smoothed experimental data for water–methanol mixtures plotted in both kinds of graphs, and the resulting partial molar volumes as functions of composition. Note in Fig. 9.3(c) how the V_A curve mirrors the V_B curve as x_B varies, as predicted by the Gibbs–Duhem equation. The minimum in V_B at $x_B \approx 0.09$ is mirrored by a maximum in V_A in agreement with Eq. 9.2.14; the maximum is much attenuated because n_B/n_A is much less than unity.

Macroscopic measurements are unable to provide unambiguous information about molecular structure. Nevertheless, it is interesting to speculate on the implications of the minimum observed for the partial molar volume of methanol. One interpretation is that in a mostly aqueous environment, there is association of methanol molecules, perhaps involving the formation of dimers.

9.2.4 General relations

The discussion above of partial molar volumes used the notation $V_{m,A}^*$ and $V_{m,B}^*$ for the molar volumes of pure A and B. The partial molar volume of a pure substance is the same as the molar volume, so we can simplify the notation by using V_A^* and V_B^* instead. Hereafter, this book will denote molar quantities of pure substances by such symbols as V_A^* , H_B^* , and S_i^* .

The relations derived above for the volume of a binary mixture may be generalized for any extensive property X of a mixture of any number of constituents. The partial molar quantity of species i , defined by

$$X_i \stackrel{\text{def}}{=} \left(\frac{\partial X}{\partial n_i}\right)_{T,p,n_{j \neq i}}
 \tag{9.2.24}$$

is an intensive property that depends on T , p , and the composition of the mixture. The additivity rule for property X is

$$X = \sum_i n_i X_i
 \tag{9.2.25}$$

(mixture)

and the Gibbs–Duhem equation applied to X can be written in the equivalent forms

$$\sum_i n_i dX_i = 0 \quad (9.2.26)$$

(constant T and p)

and

$$\sum_i x_i dX_i = 0 \quad (9.2.27)$$

(constant T and p)

These relations can be applied to a mixture in which each species i is a nonelectrolyte substance, an electrolyte substance that is dissociated into ions, or an individual ionic species. In Eq. 9.2.27, the mole fraction x_i must be based on the different species considered to be present in the mixture. For example, an aqueous solution of NaCl could be treated as a mixture of components A=H₂O and B=NaCl, with x_B equal to $n_B/(n_A + n_B)$; or the constituents could be taken as H₂O, Na⁺, and Cl⁻, in which case the mole fraction of Na⁺ would be $x_+ = n_+/(n_A + n_+ + n_-)$.

A general method to evaluate the partial molar quantities X_A and X_B in a binary mixture is based on the variant of the method of intercepts described in Sec. 9.2.3. The molar mixing quantity $\Delta X(\text{mix})/n$ is plotted versus x_B , where $\Delta X(\text{mix})$ is $(X - n_A X_A^* - n_B X_B^*)$. On this plot, the tangent to the curve at the composition of interest has intercepts equal to $X_A - X_A^*$ at $x_B=0$ and $X_B - X_B^*$ at $x_B=1$.

We can obtain experimental values of such partial molar quantities of an uncharged species as V_i , $C_{p,i}$, and S_i . It is not possible, however, to evaluate the partial molar quantities U_i , H_i , A_i , and G_i because these quantities involve the internal energy brought into the system by the species, and we cannot evaluate the absolute value of internal energy (Sec. 2.6.2). For example, while we can evaluate the difference $H_i - H_i^*$ from calorimetric measurements of enthalpies of mixing, we cannot evaluate the partial molar enthalpy H_i itself. We can, however, include such quantities as H_i in useful theoretical relations.

As mentioned on page 228, a partial molar quantity of a *charged* species is something else we cannot evaluate. It is possible, however, to obtain values relative to a reference ion. Consider an aqueous solution of a fully-dissociated electrolyte solute with the formula $M_{\nu_+} X_{\nu_-}$, where ν_+ and ν_- are the numbers of cations and anions per solute formula unit. The partial molar volume V_B of the solute, which can be determined experimentally, is related to the (unmeasurable) partial molar volumes V_+ and V_- of the constituent ions by

$$V_B = \nu_+ V_+ + \nu_- V_- \quad (9.2.28)$$

For aqueous solutions, the usual reference ion is H⁺, and the partial molar volume of this ion at infinite dilution is arbitrarily set equal to zero: $V_{\text{H}^+}^\infty = 0$.

For example, given the value (at 298.15 K and 1 bar) of the partial molar volume at infinite dilution of aqueous hydrogen chloride

$$V_{\text{HCl}}^\infty = 17.82 \text{ cm}^3 \text{ mol}^{-1} \quad (9.2.29)$$

we can find the so-called “conventional” partial molar volume of Cl⁻ ion:

$$V_{\text{Cl}^-}^\infty = V_{\text{HCl}}^\infty - V_{\text{H}^+}^\infty = 17.82 \text{ cm}^3 \text{ mol}^{-1} \quad (9.2.30)$$

Going one step further, the measured value $V_{\text{NaCl}}^\infty = 16.61 \text{ cm}^3 \text{ mol}^{-1}$ gives, for Na⁺ ion, the conventional value

$$V_{\text{Na}^+}^\infty = V_{\text{NaCl}}^\infty - V_{\text{Cl}^-}^\infty = (16.61 - 17.82) \text{ cm}^3 \text{ mol}^{-1} = -1.21 \text{ cm}^3 \text{ mol}^{-1} \quad (9.2.31)$$

9.2.5 Partial specific quantities

A **partial specific quantity** of a substance is the partial molar quantity divided by the molar mass, and has dimensions of volume divided by mass. For example, the partial specific volume v_B of solute B in a binary solution is given by

$$v_B = \frac{V_B}{M_B} = \left[\frac{\partial V}{\partial m(B)} \right]_{T,p,m(A)} \quad (9.2.32)$$

where $m(A)$ and $m(B)$ are the masses of solvent and solute.

Although this book makes little use of specific quantities and partial specific quantities, in some applications they have an advantage over molar quantities and partial molar quantities because they can be evaluated without knowledge of the molar mass. For instance, the value of a solute's partial specific volume is used to determine its molar mass by the method of sedimentation equilibrium (Sec. 9.8.2).

The general relations in Sec. 9.2.4 involving partial molar quantities may be turned into relations involving partial specific quantities by replacing amounts by masses, mole fractions by mass fractions, and partial molar quantities by partial specific quantities. Using volume as an example, we can write an additivity relation $V = \sum_i m(i)v_i$, and Gibbs–Duhem relations $\sum_i m(i) dv_i = 0$ and $\sum_i w_i dv_i = 0$. For a binary mixture of A and B, we can plot the specific volume v versus the mass fraction w_B ; then the tangent to the curve at a given composition has intercepts equal to v_A at $w_B=0$ and v_B at $w_B=1$. A variant of this plot is $(v - w_A v_A^* - w_B v_B^*)$ versus w_B ; the intercepts are then equal to $v_A - v_A^*$ and $v_B - v_B^*$.

9.2.6 The chemical potential of a species in a mixture

Just as the molar Gibbs energy of a pure substance is called the *chemical potential* and given the special symbol μ , the partial molar Gibbs energy G_i of species i in a mixture is called the **chemical potential** of species i , defined by

$$\mu_i \stackrel{\text{def}}{=} \left(\frac{\partial G}{\partial n_i} \right)_{T,p,n_{j \neq i}} \quad (9.2.33)$$

(mixture)

If there are work coordinates for nonexpansion work, the partial derivative is taken at constant values of these coordinates.

The chemical potential of a species in a phase plays a crucial role in equilibrium problems, because it is a measure of the escaping tendency of the species from the phase. Although we cannot determine the absolute value of μ_i for a given state of the system, we are usually able to evaluate the difference between the value in this state and the value in a defined reference state.

In an open single-phase system containing a mixture of s different nonreacting species, we may in principle independently vary T , p , and the amount of each species. This is a total of $2 + s$ independent variables. The total differential of the Gibbs energy of this system is given by Eq. 5.5.9 on page 145, often called the Gibbs fundamental equation:

$$dG = -S dT + V dp + \sum_{i=1}^s \mu_i dn_i \quad (9.2.34)$$

(mixture)

Consider the special case of a mixture containing *charged* species, for example an aqueous solution of the electrolyte KCl. We could consider the constituents to be either the substances H₂O and KCl, or else H₂O and the species K⁺ and Cl⁻. Any mixture we can prepare in the laboratory must remain electrically neutral, or virtually so. Thus, while we are able to independently vary the amounts of H₂O and KCl, we cannot in practice independently vary the amounts of K⁺ and Cl⁻ in the mixture. The chemical potential of the K⁺ ion is defined as the rate at which the Gibbs energy changes with the amount of K⁺ added at constant T and p while the amount of Cl⁻ is kept constant. This is a hypothetical process in which the net charge of the mixture increases. The chemical potential of an ion is therefore a valid but purely theoretical concept. Let A stand for H₂O, B for KCl, + for K⁺, and - for Cl⁻. Then it is theoretically valid to write the total differential of G for the KCl solution either as

$$dG = -S dT + V dp + \mu_A dn_A + \mu_B dn_B \quad (9.2.35)$$

or as

$$dG = -S dT + V dp + \mu_A dn_A + \mu_+ dn_+ + \mu_- dn_- \quad (9.2.36)$$

9.2.7 Equilibrium conditions in a multiphase, multicomponent system

This section extends the derivation described in Sec. 8.1.2, which was for equilibrium conditions in a multiphase system containing a single substance, to a more general kind of system: one with two or more homogeneous phases containing mixtures of nonreacting species. The derivation assumes there are no internal partitions that could prevent transfer of species and energy between the phases, and that effects of gravity and other external force fields are negligible.

The system consists of a reference phase, α' , and other phases labeled by $\alpha \neq \alpha'$. Species are labeled by subscript i . Following the procedure of Sec. 8.1.1, we write for the total differential of the internal energy

$$\begin{aligned} dU &= dU^{\alpha'} + \sum_{\alpha \neq \alpha'} dU^\alpha \\ &= T^{\alpha'} dS^{\alpha'} - p^{\alpha'} dV^{\alpha'} + \sum_i \mu_i^{\alpha'} dn_i^{\alpha'} \\ &\quad + \sum_{\alpha \neq \alpha'} \left(T^\alpha dS^\alpha - p^\alpha dV^\alpha + \sum_i \mu_i^\alpha dn_i^\alpha \right) \end{aligned} \quad (9.2.37)$$

The conditions of isolation are

$$dU = 0 \quad (\text{constant internal energy}) \quad (9.2.38)$$

$$dV^{\alpha'} + \sum_{\alpha \neq \alpha'} dV^\alpha = 0 \quad (\text{no expansion work}) \quad (9.2.39)$$

For each species i :

$$dn_i^{\alpha'} + \sum_{\alpha \neq \alpha'} dn_i^\alpha = 0 \quad (\text{closed system}) \quad (9.2.40)$$

We use these relations to substitute for dU , $dV^{\alpha'}$, and $dn_i^{\alpha'}$ in Eq. 9.2.37. After making the further substitution $dS^{\alpha'} = dS - \sum_{\alpha \neq \alpha'} dS^{\alpha}$ and solving for dS , we obtain

$$dS = \sum_{\alpha \neq \alpha'} \frac{T^{\alpha'} - T^{\alpha}}{T^{\alpha'}} dS^{\alpha} - \sum_{\alpha \neq \alpha'} \frac{p^{\alpha'} - p^{\alpha}}{T^{\alpha'}} dV^{\alpha} + \sum_i \sum_{\alpha \neq \alpha'} \frac{\mu_i^{\alpha'} - \mu_i^{\alpha}}{T^{\alpha'}} dn_i^{\alpha} \quad (9.2.41)$$

This equation is like Eq. 8.1.6 on page 196 with provision for more than one species.

In the equilibrium state of the isolated system, S has the maximum possible value, dS is equal to zero for an infinitesimal change of any of the independent variables, and the coefficient of each term on the right side of Eq. 9.2.41 is zero. We find that in this state each phase has the same temperature and the same pressure, and for each species the chemical potential is the same in each phase.

Suppose the system contains a species i' that is effectively excluded from a particular phase, α'' . For instance, sucrose molecules dissolved in an aqueous phase are not accommodated in the crystal structure of an ice phase, and a nonpolar substance may be essentially insoluble in an aqueous phase. We can treat this kind of situation by setting $dn_i^{\alpha''}$ equal to zero. Consequently there is no equilibrium condition involving the chemical potential of this species in phase α'' .

To summarize these conclusions: In an equilibrium state of a multiphase, multicomponent system without internal partitions, the temperature and pressure are uniform throughout the system, and each species has a uniform chemical potential except in phases where it is excluded.

This statement regarding the uniform chemical potential of a species applies to both a substance and an ion, as the following argument explains. The derivation in this section begins with Eq. 9.2.37, an expression for the total differential of U . Because it is a total differential, the expression requires the amount n_i of each species i in each phase to be an independent variable. Suppose one of the phases is the aqueous solution of KCl used as an example at the end of the preceding section. In principle (but not in practice), the amounts of the species H_2O , K^+ , and Cl^- can be varied independently, so that it is valid to include these three species in the sums over i in Eq. 9.2.37. The derivation then leads to the conclusion that K^+ has the same chemical potential in phases that are in transfer equilibrium with respect to K^+ , and likewise for Cl^- . This kind of situation arises when we consider a Donnan membrane equilibrium (Sec. 12.7.3) in which transfer equilibrium of ions exists between solutions of electrolytes separated by a semipermeable membrane.

9.2.8 Relations involving partial molar quantities

Here we derive several useful relations involving partial molar quantities in a single-phase system that is a mixture. The independent variables are T , p , and the amount n_i of each constituent species i .

From Eqs. 9.2.26 and 9.2.27, the Gibbs–Duhem equation applied to the chemical potentials can be written in the equivalent forms

$$\sum_i n_i d\mu_i = 0 \quad (9.2.42)$$

(constant T and p)

and

$$\sum_i x_i d\mu_i = 0 \quad (9.2.43)$$

(constant T and p)

These equations show that the chemical potentials of different species cannot be varied independently at constant T and p .

A more general version of the Gibbs–Duhem equation, without the restriction of constant T and p , is

$$S dT - V dp + \sum_i n_i d\mu_i = 0 \quad (9.2.44)$$

This version is derived by comparing the expression for dG given by Eq. 9.2.34 with the differential $dG = \sum_i \mu_i dn_i + \sum_i n_i d\mu_i$ obtained from the additivity rule $G = \sum_i \mu_i n_i$.

The Gibbs energy is defined by $G = H - TS$. Taking the partial derivatives of both sides of this equation with respect to n_i at constant T , p , and $n_{j \neq i}$ gives us

$$\left(\frac{\partial G}{\partial n_i}\right)_{T,p,n_{j \neq i}} = \left(\frac{\partial H}{\partial n_i}\right)_{T,p,n_{j \neq i}} - T \left(\frac{\partial S}{\partial n_i}\right)_{T,p,n_{j \neq i}} \quad (9.2.45)$$

We recognize each partial derivative as a partial molar quantity and rewrite the equation as

$$\mu_i = H_i - TS_i \quad (9.2.46)$$

This is analogous to the relation $\mu = G/n = H_m - TS_m$ for a pure substance.

From the total differential of the Gibbs energy, $dG = -S dT + V dp + \sum_i \mu_i dn_i$ (Eq. 9.2.34), we obtain the following reciprocity relations:

$$\left(\frac{\partial \mu_i}{\partial T}\right)_{p,\{n_i\}} = -\left(\frac{\partial S}{\partial n_i}\right)_{T,p,n_{j \neq i}} \quad \left(\frac{\partial \mu_i}{\partial p}\right)_{T,\{n_i\}} = \left(\frac{\partial V}{\partial n_i}\right)_{T,p,n_{j \neq i}} \quad (9.2.47)$$

The symbol $\{n_i\}$ stands for the set of amounts of all species, and subscript $\{n_i\}$ on a partial derivative means the amount of *each* species is constant—that is, the derivative is taken at constant composition of a closed system. Again we recognize partial derivatives as partial molar quantities and rewrite these relations as follows:

$$\left(\frac{\partial \mu_i}{\partial T}\right)_{p,\{n_i\}} = -S_i \quad (9.2.48)$$

$$\left(\frac{\partial \mu_i}{\partial p}\right)_{T,\{n_i\}} = V_i \quad (9.2.49)$$

These equations are the equivalent for a mixture of the relations $(\partial\mu/\partial T)_p = -S_m$ and $(\partial\mu/\partial p)_T = V_m$ for a pure phase (Eqs. 7.8.3 and 7.8.4).

Taking the partial derivatives of both sides of $U = H - pV$ with respect to n_i at constant T , p , and $n_{j \neq i}$ gives

$$U_i = H_i - pV_i \quad (9.2.50)$$

Finally, we can obtain a formula for $C_{p,i}$, the partial molar heat capacity at constant pressure of species i , by writing the total differential of H in the form

$$\begin{aligned} dH &= \left(\frac{\partial H}{\partial T} \right)_{p, \{n_i\}} dT + \left(\frac{\partial H}{\partial p} \right)_{T, \{n_i\}} dp + \sum_i \left(\frac{\partial H}{\partial n_i} \right)_{T, p, n_{j \neq i}} dn_i \\ &= C_p dT + \left(\frac{\partial H}{\partial p} \right)_{T, \{n_i\}} dp + \sum_i H_i dn_i \end{aligned} \quad (9.2.51)$$

from which we have the reciprocity relation $(\partial C_p / \partial n_i)_{T, p, n_{j \neq i}} = (\partial H_i / \partial T)_{p, \{n_i\}}$, or

$$C_{p,i} = \left(\frac{\partial H_i}{\partial T} \right)_{p, \{n_i\}} \quad (9.2.52)$$

9.3 Gas Mixtures

The gas mixtures described in this chapter are assumed to be mixtures of nonreacting gaseous substances.

9.3.1 Partial pressure

The **partial pressure** p_i of substance i in a gas mixture is defined as the product of its mole fraction in the gas phase and the pressure of the phase:

$$p_i \stackrel{\text{def}}{=} y_i p \quad (9.3.1)$$

(gas mixture)

The sum of the partial pressures of all substances in a gas mixture is $\sum_i p_i = \sum_i y_i p = p \sum_i y_i$. Since the sum of the mole fractions of all substances in a mixture is 1, this sum becomes

$$\sum_i p_i = p \quad (9.3.2)$$

(gas mixture)

Thus, the sum of the partial pressures equals the pressure of the gas phase. This statement is known as **Dalton's Law**. It is valid for any gas mixture, regardless of whether or not the gas obeys the ideal gas equation.

9.3.2 The ideal gas mixture

As discussed in Sec. 3.5.1, an ideal gas (whether pure or a mixture) is a gas with negligible intermolecular interactions. It obeys the ideal gas equation $p = nRT/V$ (where n in a mixture is the sum $\sum_i n_i$) and its internal energy in a closed system is a function only of

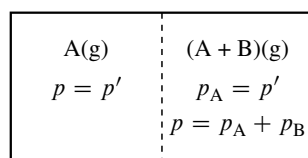

Figure 9.4 System with two gas phases, pure A and a mixture of A and B, separated by a semipermeable membrane through which only A can pass. Both phases are ideal gases at the same temperature.

temperature. The partial pressure of substance i in an ideal gas mixture is $p_i = y_i p = y_i nRT/V$; but $y_i n$ equals n_i , giving

$$p_i = \frac{n_i RT}{V} \quad (9.3.3)$$

(ideal gas mixture)

Equation 9.3.3 is the ideal gas equation with the partial pressure of a constituent substance replacing the total pressure, and the amount of the substance replacing the total amount. The equation shows that the partial pressure of a substance in an ideal gas mixture is the pressure the substance by itself, with all others removed from the system, would have at the same T and V as the mixture. Note that this statement is only true for an *ideal* gas mixture. The partial pressure of a substance in a real gas mixture is in general different from the pressure of the pure substance at the same T and V , because the intermolecular interactions are different.

9.3.3 Partial molar quantities in an ideal gas mixture

We need to relate the chemical potential of a constituent of a gas mixture to its partial pressure. We cannot measure the absolute value of a chemical potential, but we can evaluate its value relative to the chemical potential in a particular reference state called the standard state.

The *standard state of substance i in a gas mixture* is the same as the standard state of the pure gas described in Sec. 7.7: It is the hypothetical state in which pure gaseous i has the same temperature as the mixture, is at the standard pressure p° , and behaves as an ideal gas. The standard chemical potential $\mu_i^\circ(\text{g})$ of gaseous i is the chemical potential of i in this gas standard state, and is a function of temperature.

To derive an expression for μ_i in an ideal gas mixture relative to $\mu_i^\circ(\text{g})$, we make an assumption based on the following argument. Suppose we place pure A, an ideal gas, in a rigid box at pressure p' . We then slide a rigid membrane into the box so as to divide the box into two compartments. The membrane is permeable to A; that is, molecules of A pass freely through its pores. There is no reason to expect the membrane to affect the pressures on either side,⁶ which remain equal to p' . Finally, without changing the volume of either compartment, we add a second gaseous substance, B, to one side of the membrane to form an ideal gas mixture, as shown in Fig. 9.4. The membrane is impermeable to B, so the molecules of B stay in one compartment and cause a pressure increase there. Since the

⁶We assume the gas is not adsorbed to a significant extent on the surface of the membrane or in its pores.

mixture is an ideal gas, the molecules of A and B do not interact, and the addition of gas B causes no change in the amounts of A on either side of the membrane. Thus, the pressure of A in the pure phase and the partial pressure of A in the mixture are both equal to p' .

Our assumption, then, is that the partial pressure p_A of gas A in an ideal gas mixture in equilibrium with pure ideal gas A is equal to the pressure of the pure gas.

Because the system shown in Fig. 9.4 is in an equilibrium state, gas A must have the same chemical potential in both phases. This is true even though the phases have different pressures (see Sec. 9.2.7). Since the chemical potential of the pure ideal gas is given by $\mu = \mu^\circ(\text{g}) + RT \ln(p/p^\circ)$, and we assume that p_A in the mixture is equal to p in the pure gas, the chemical potential of A in the mixture is given by

$$\mu_A = \mu_A^\circ(\text{g}) + RT \ln \frac{p_A}{p^\circ} \quad (9.3.4)$$

In general, for each substance i in an ideal gas mixture, we have the relation

$$\mu_i = \mu_i^\circ(\text{g}) + RT \ln \frac{p_i}{p^\circ} \quad (9.3.5)$$

(ideal gas mixture)

where $\mu_i^\circ(\text{g})$ is the chemical potential of i in the gas standard state at the same temperature as the mixture.

Equation 9.3.5 shows that if the partial pressure of a constituent of an ideal gas mixture is equal to p° , so that $\ln(p_i/p^\circ)$ is zero, the chemical potential is equal to the standard chemical potential. Conceptually, a standard state should be a well-defined state of the system, which in the case of a gas is the *pure* ideal gas at $p=p^\circ$. Thus, although a constituent of an ideal gas mixture with a partial pressure of 1 bar is not in its standard state, it has the same chemical potential as in its standard state.

Equation 9.3.5 will be taken as the thermodynamic *definition* of an ideal gas mixture. Any gas mixture in which each constituent i obeys this relation between μ_i and p_i at all compositions is by definition an ideal gas mixture. The nonrigorous nature of the assumption used to obtain Eq. 9.3.5 presents no difficulty if we consider the equation to be the basic definition.

By substituting the expression for μ_i into $(\partial\mu_i/\partial T)_{p,\{n_i\}} = -S_i$ (Eq. 9.2.48), we obtain an expression for the partial molar entropy of substance i in an ideal gas mixture:

$$\begin{aligned} S_i &= - \left[\frac{\partial\mu_i^\circ(\text{g})}{\partial T} \right]_{p,\{n_i\}} - R \ln \frac{p_i}{p^\circ} \\ &= S_i^\circ - R \ln \frac{p_i}{p^\circ} \end{aligned} \quad (9.3.6)$$

(ideal gas mixture)

The quantity $S_i^\circ = -[\partial\mu_i^\circ(\text{g})/\partial T]_{p,\{n_i\}}$ is the **standard molar entropy** of constituent i . It is the molar entropy of i in its standard state of pure ideal gas at pressure p° .

Substitution of the expression for μ_i from Eq. 9.3.5 and the expression for S_i from Eq. 9.3.6 into $H_i = \mu_i + TS_i$ (from Eq. 9.2.46) yields $H_i = \mu_i^\circ(\text{g}) + TS_i^\circ$, which is equivalent to

$$H_i = H_i^\circ \quad (9.3.7)$$

(ideal gas mixture)

This tells us that the partial molar enthalpy of a constituent of an ideal gas mixture at a given temperature is *independent* of the partial pressure or mixture composition; it is a function only of T .

From $(\partial\mu_i/\partial p)_{T,\{n_i\}} = V_i$ (Eq. 9.2.49), the partial molar volume of i in an ideal gas mixture is given by

$$V_i = \left[\frac{\partial\mu_i^\circ(\text{g})}{\partial p} \right]_{T,\{n_i\}} + RT \left[\frac{\partial \ln(p_i/p^\circ)}{\partial p} \right]_{T,\{n_i\}} \quad (9.3.8)$$

The first partial derivative on the right is zero because $\mu_i^\circ(\text{g})$ is a function only of T . For the second partial derivative, we write $p_i/p^\circ = y_i p/p^\circ$. The mole fraction y_i is constant when the amount of each substance is constant, so we have $[\partial \ln(y_i p/p^\circ)/\partial p]_{T,\{n_i\}} = 1/p$. The partial molar volume is therefore given by

$$V_i = \frac{RT}{p} \quad (9.3.9)$$

(ideal gas mixture)

which is what we would expect simply from the ideal gas equation. The partial molar volume is not necessarily equal to the standard molar volume, which is $V_i^\circ = RT/p^\circ$ for an ideal gas.

From Eqs. 9.2.50, 9.2.52, 9.3.7, and 9.3.9 we obtain the relations

$$U_i = U_i^\circ \quad (9.3.10)$$

(ideal gas mixture)

and

$$C_{p,i} = C_{p,i}^\circ \quad (9.3.11)$$

(ideal gas mixture)

Thus, in an ideal gas mixture the partial molar internal energy and the partial molar heat capacity at constant pressure, like the partial molar enthalpy, are functions only of T .

The definition of an ideal gas mixture given by Eq. 9.3.5 is consistent with the criteria for an ideal gas listed at the beginning of Sec. 3.5.1, as the following derivation shows. From Eq. 9.3.9 and the additivity rule, we find the volume is given by $V = \sum_i n_i V_i = \sum_i n_i RT/p = nRT/p$, which is the ideal gas equation. From Eq. 9.3.10 we have $U = \sum_i n_i U_i = \sum_i n_i U_i^\circ$, showing that U is a function only of T in a closed system. These properties apply to any gas mixture obeying Eq. 9.3.5, and they are the properties that define an ideal gas according to Sec. 3.5.1.

9.3.4 Real gas mixtures

Fugacity

The fugacity f of a pure gas is defined by $\mu = \mu^\circ(\text{g}) + RT \ln(f/p^\circ)$ (Eq. 7.8.7 on page 185). By analogy with this equation, the fugacity f_i of substance i in a real gas mixture is defined by the relation

$$\mu_i = \mu_i^\circ(\text{g}) + RT \ln \frac{f_i}{p^\circ} \quad \text{or} \quad f_i \stackrel{\text{def}}{=} p^\circ \exp \left[\frac{\mu_i - \mu_i^\circ(\text{g})}{RT} \right] \quad (9.3.12)$$

(gas mixture)

Just as the fugacity of a pure gas is a kind of effective pressure, the fugacity of a constituent of a gas mixture is a kind of effective *partial* pressure. That is, f_i is the partial pressure substance i would have in an ideal gas mixture that is at the same temperature as the real gas mixture and in which the chemical potential of i is the same as in the real gas mixture.

To derive a relation allowing us to evaluate f_i from the pressure–volume properties of the gaseous mixture, we follow the steps described for a pure gas in Sec. 7.8.1. The temperature and composition are constant. From Eq. 9.3.12, the difference between the chemical potentials of substance i in the mixture at pressures p' and p'' is

$$\mu'_i - \mu''_i = RT \ln \frac{f'_i}{f''_i} \quad (9.3.13)$$

Integration of $d\mu_i = V_i dp$ (from Eq. 9.2.49) between these pressures yields

$$\mu'_i - \mu''_i = \int_{p''}^{p'} V_i dp \quad (9.3.14)$$

When we equate these two expressions for $\mu'_i - \mu''_i$, divide both sides by RT , subtract the identity

$$\ln \frac{p'}{p''} = \int_{p''}^{p'} \frac{dp}{p} \quad (9.3.15)$$

and take the ideal-gas behavior limits $p'' \rightarrow 0$ and $f''_i \rightarrow y_i p'' = (p'_i/p')p''$, we obtain

$$\ln \frac{f'_i}{p'_i} = \int_0^{p'} \left(\frac{V_i}{RT} - \frac{1}{p} \right) dp \quad (9.3.16)$$

(gas mixture, constant T)

The fugacity coefficient ϕ_i of constituent i is defined by

$$f_i \stackrel{\text{def}}{=} \phi_i p_i \quad (9.3.17)$$

(gas mixture)

Accordingly, the fugacity coefficient at pressure p' is given by

$$\ln \phi_i(p') = \int_0^{p'} \left(\frac{V_i}{RT} - \frac{1}{p} \right) dp \quad (9.3.18)$$

(gas mixture, constant T)

As p' approaches zero, the integral in Eqs. 9.3.16 and 9.3.18 approaches zero, f'_i approaches p'_i , and $\phi_i(p')$ approaches unity.

Partial molar quantities

By combining Eqs. 9.3.12 and 9.3.16, we obtain

$$\mu_i(p') = \mu_i^\circ(\text{g}) + RT \ln \frac{p'_i}{p^\circ} + \int_0^{p'} \left(V_i - \frac{RT}{p} \right) dp \quad (9.3.19)$$

(gas mixture, constant T)

Table 9.1 Gas mixture: expressions for differences between partial molar and standard molar quantities of constituent i

Difference	General expression at pressure p'	Equation of state ^a $V = nRT/p + nB$
$\mu_i - \mu_i^\circ(\text{g})$	$RT \ln \frac{p'_i}{p^\circ} + \int_0^{p'} \left(V_i - \frac{RT}{p} \right) dp$	$RT \ln \frac{p_i}{p^\circ} + B'_i p$
$S_i - S_i^\circ(\text{g})$	$-R \ln \frac{p'_i}{p^\circ} - \int_0^{p'} \left[\left(\frac{\partial V_i}{\partial T} \right)_p - \frac{R}{p} \right] dp$	$-R \ln \frac{p_i}{p^\circ} - p \frac{dB'_i}{dT}$
$H_i - H_i^\circ(\text{g})$	$\int_0^{p'} \left[V_i - T \left(\frac{\partial V_i}{\partial T} \right)_p \right] dp$	$p \left(B'_i - T \frac{dB'_i}{dT} \right)$
$U_i - U_i^\circ(\text{g})$	$\int_0^{p'} \left[V_i - T \left(\frac{\partial V_i}{\partial T} \right)_p \right] dp + RT - p'V_i$	$-pT \frac{dB'_i}{dT}$
$C_{p,i} - C_{p,i}^\circ(\text{g})$	$-\int_0^{p'} T \left(\frac{\partial^2 V_i}{\partial T^2} \right)_p dp$	$-pT \frac{d^2 B'_i}{dT^2}$

^a B and B'_i are defined by Eqs. 9.3.24 and 9.3.26

which is the analogue for a gas mixture of Eq. 7.9.2 for a pure gas. Section 7.9 describes the procedure needed to obtain formulas for various molar quantities of a pure gas from Eq. 7.9.2. By following a similar procedure with Eq. 9.3.19, we obtain the formulas for differences between partial molar and standard molar quantities of a constituent of a gas mixture shown in the second column of Table 9.1. These formulas are obtained with the help of Eqs. 9.2.46, 9.2.48, 9.2.50, and 9.2.52.

Equation of state

The equation of state of a real gas mixture can be written as the virial equation

$$pV/n = RT \left[1 + \frac{B}{(V/n)} + \frac{C}{(V/n)^2} + \dots \right] \quad (9.3.20)$$

This equation is the same as Eq. 2.2.2 for a pure gas, except that the molar volume V_m is replaced by the mean molar volume V/n , and the virial coefficients B, C, \dots depend on composition as well as temperature.

At low to moderate pressures, the simple equation of state

$$V/n = \frac{RT}{p} + B \quad (9.3.21)$$

describes a gas mixture to a sufficiently high degree of accuracy (see Eq. 2.2.8 on page 35). This is equivalent to a compression factor given by

$$Z \stackrel{\text{def}}{=} \frac{pV}{nRT} = 1 + \frac{Bp}{RT} \quad (9.3.22)$$

From statistical mechanical theory, the dependence of the second virial coefficient B of a binary gas mixture on the mole fraction composition is given by

$$B = y_A^2 B_{AA} + 2y_A y_B B_{AB} + y_B^2 B_{BB} \quad (9.3.23)$$

(binary gas mixture)

where B_{AA} and B_{BB} are the second virial coefficients of pure A and B, and B_{AB} is a mixed second virial coefficient. B_{AA} , B_{BB} , and B_{AB} are functions of T only. For a gas mixture with any number of constituents, the composition dependence of B is given by

$$B = \sum_i \sum_j y_i y_j B_{ij} \quad (9.3.24)$$

(gas mixture, $B_{ij} = B_{ji}$)

Here B_{ij} is the second virial of i if i and j are the same, or a mixed second virial coefficient if i and j are different.

If a gas mixture obeys the equation of state of Eq. 9.3.21, the partial molar volume of constituent i is given by

$$V_i = \frac{RT}{p} + B'_i \quad (9.3.25)$$

where the quantity B'_i , in order to be consistent with $V_i = (\partial V / \partial n_i)_{T,p,n_{j \neq i}}$, is found to be given by

$$B'_i = 2 \sum_j y_j B_{ij} - B \quad (9.3.26)$$

For the constituents of a binary mixture of A and B, Eq. 9.3.26 becomes

$$B'_A = B_{AA} + (-B_{AA} + 2B_{AB} - B_{BB})y_B^2 \quad (9.3.27)$$

(binary gas mixture)

$$B'_B = B_{BB} + (-B_{AA} + 2B_{AB} - B_{BB})y_A^2 \quad (9.3.28)$$

(binary gas mixture)

When we substitute the expression of Eq. 9.3.25 for V_i in Eq. 9.3.18, we obtain a relation between the fugacity coefficient of constituent i and the function B'_i :

$$\ln \phi_i = \frac{B'_i p}{RT} \quad (9.3.29)$$

The third column of Table 9.1 gives formulas for various partial molar quantities of constituent i in terms of B'_i and its temperature derivative. The formulas are the same as the approximate formulas in the third column of Table 7.5 for molar quantities of a *pure* gas, with B'_i replacing the second virial coefficient B .

9.4 Liquid and Solid Mixtures of Nonelectrolytes

Homogeneous liquid and solid mixtures are condensed phases of variable composition. Most of the discussion of condensed-phase mixtures in this section focuses on liquids. The same principles, however, apply to homogeneous solid mixtures, often called solid

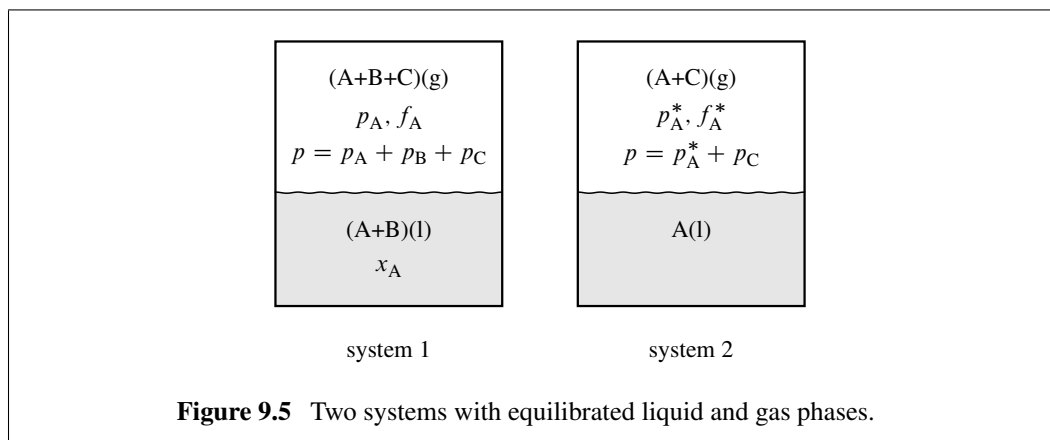

solutions. These solid mixtures include most metal alloys, many gemstones, and doped semiconductors.

The relations derived in this section apply to mixtures of nonelectrolytes—substances that do not dissociate into charged species. Solutions of electrolytes behave quite differently in many ways, and will be discussed in the next chapter.

9.4.1 Raoult's law

In 1888, the French physical chemist François Raoult published his finding that when a dilute liquid solution of a volatile solvent and a nonelectrolyte solute is equilibrated with a gas phase, the partial pressure p_A of the solvent in the gas phase is proportional to the mole fraction x_A of the solvent in the solution:

$$p_A = x_A p_A^* \quad (9.4.1)$$

Here p_A^* is the saturation vapor pressure of the pure solvent (the pressure at which the pure liquid and pure gas phases are in equilibrium).

In order to place Raoult's law in a rigorous thermodynamic framework, consider the two systems depicted in Fig. 9.5. The liquid phase of system 1 is a binary solution of solvent A and solute B, whereas the liquid in system 2 is the pure solvent. In system 1, the partial pressure p_A in the equilibrated gas phase depends on the temperature and the solution composition. In system 2, p_A^* depends on the temperature. Both p_A and p_A^* have a mild dependence on the total pressure p , which can be varied with an inert gas constituent C of negligible solubility in the liquid.

Suppose that we vary the composition of the solution in system 1 at constant temperature, while adjusting the partial pressure of C so as to keep p constant. If we find that the partial pressure of the solvent over a range of composition is given by $p_A = x_A p_A^*$, where p_A^* is the partial pressure of A in system 2 at the same T and p , we will say that the solvent obeys *Raoult's law for partial pressure* in this range. This is the same as the original Raoult's law, except that p_A^* is now the vapor pressure of pure liquid A at the pressure p of the liquid mixture. Section 12.8.1 will show that unless p is much greater than p_A^* , p_A^* is practically the same as the saturation vapor pressure of pure liquid A, in which case Raoult's law for partial pressure becomes identical to the original law.

A form of Raoult's law with fugacities in place of partial pressures is often more useful: $f_A = x_A f_A^*$, where f_A^* is the fugacity of A in the gas phase of system 2 at the same T and p as the solution. If this relation is found to hold over a given composition range, we will say the solvent in this range obeys *Raoult's law for fugacity*.

We can generalize the two forms of Raoult's law for any constituent i of a liquid mixture:

$$p_i = x_i p_i^* \quad (9.4.2)$$

(Raoult's law for partial pressure)

$$f_i = x_i f_i^* \quad (9.4.3)$$

(Raoult's law for fugacity)

Here x_i is the mole fraction of i in the liquid mixture, and p_i^* and f_i^* are the partial pressure and fugacity in a gas phase equilibrated with pure liquid i at the same T and p as the liquid mixture. Both p_i^* and f_i^* are functions of T and p .

These two forms of Raoult's law are equivalent when the gas phases are ideal gas mixtures. When it is necessary to make a distinction between the two forms, this book will refer specifically to Raoult's law for partial pressure or Raoult's law for fugacity.

Raoult's law for fugacity can be recast in terms of chemical potential. Section 9.2.7 showed that if substance i has transfer equilibrium between a liquid and a gas phase, its chemical potential μ_i is the same in both equilibrated phases. The chemical potential in the gas phase is given by $\mu_i = \mu_i^\circ(\text{g}) + RT \ln f_i/p^\circ$ (Eq. 9.3.12). Replacing f_i by $x_i f_i^*$ according to Raoult's law, and rearranging, we obtain

$$\mu_i = \left[\mu_i^\circ(\text{g}) + RT \ln \frac{f_i^*}{p^\circ} \right] + RT \ln x_i \quad (9.4.4)$$

The expression in brackets is independent of the mixture composition. We replace this expression by a quantity μ_i^* , a function of T and p , and write

$$\mu_i = \mu_i^* + RT \ln x_i \quad (9.4.5)$$

Equation 9.4.5 is an expression for the chemical potential in the liquid phase when Raoult's law for fugacity is obeyed. By setting x_i equal to 1, we see that μ_i^* represents the chemical potential of pure liquid i at the temperature and pressure of the mixture. Because Eq. 9.4.5 is valid for any constituent whose fugacity obeys Eq. 9.4.3, it is equivalent to Raoult's law for fugacity for that constituent.

9.4.2 Ideal mixtures

Depending on the temperature, pressure, and identity of the constituents of a liquid mixture, Raoult's law for fugacity may hold for constituent i at all liquid compositions, or over only a limited composition range when x_i is close to unity.

An *ideal liquid mixture* is defined as a liquid mixture in which, at a given temperature and pressure, *each* constituent obeys Raoult's law for fugacity (Eq. 9.4.3 or 9.4.5) over the entire range of composition. Equation 9.4.3 applies only to a volatile constituent, whereas Eq. 9.4.5 applies regardless of whether the constituent is volatile.

Few liquid mixtures are found to approximate the behavior of an ideal liquid mixture. In order to do so, the constituents must have similar molecular size and structure, and the pure liquids must be miscible in all proportions. Benzene and toluene, for instance, satisfy these requirements, and liquid mixtures of benzene and toluene are found to obey Raoult's law quite closely. In contrast, water and methanol, although miscible in all proportions, form liquid mixtures that deviate considerably from Raoult's law. The most commonly encountered situation for mixtures of organic liquids is that each constituent deviates from Raoult's law behavior by having a *higher* fugacity than predicted by Eq. 9.4.3—a *positive* deviation from Raoult's law.

Similar statements apply to ideal *solid* mixtures. In addition, a relation with the same form as Eq. 9.4.5 describes the chemical potential of each constituent of an ideal *gas* mixture, as the following derivation shows. In an ideal gas mixture at a given T and p , the chemical potential of substance i is given by Eq. 9.3.5:

$$\mu_i = \mu_i^\circ(\text{g}) + RT \ln \frac{P_i}{p^\circ} = \mu_i^\circ(\text{g}) + RT \ln \frac{y_i P}{p^\circ} \quad (9.4.6)$$

Here y_i is the mole fraction of i in the gas. The chemical potential of the pure ideal gas ($y_i=1$) is

$$\mu_i^* = \mu_i^\circ(\text{g}) + RT \ln \frac{P}{p^\circ} \quad (9.4.7)$$

By eliminating $\mu_i^\circ(\text{g})$ between these equations and rearranging, we obtain Eq. 9.4.5 with x_i replaced by y_i .

Thus, an **ideal mixture**, whether solid, liquid, or gas, is a mixture in which the chemical potential of each constituent at a given T and p is a linear function of the logarithm of the mole fraction:

$$\mu_i = \mu_i^* + RT \ln x_i \quad (9.4.8)$$

(ideal mixture)

9.4.3 Partial molar quantities in ideal mixtures

With the help of Eq. 9.4.8 for the chemical potential of a constituent of an ideal mixture, we will now be able to find expressions for partial molar quantities. These expressions find their greatest use for ideal liquid and solid mixtures.

For the partial molar entropy of substance i , we have $S_i = -(\partial\mu_i/\partial T)_{p,\{n_i\}}$ (from Eq. 9.2.48) or, for the ideal mixture,

$$S_i = -\left(\frac{\partial\mu_i^*}{\partial T}\right)_p - R \ln x_i = S_i^* - R \ln x_i \quad (9.4.9)$$

(ideal mixture)

Since $\ln x_i$ is negative in a mixture, the partial molar entropy of a constituent of an ideal mixture is greater than the molar entropy of the pure substance at the same T and p .

For the partial molar enthalpy, we have $H_i = \mu_i + TS_i$ (from Eq. 9.2.46). Using the expressions for μ_i and S_i gives us

$$H_i = \mu_i^* + TS_i^* = H_i^* \quad (9.4.10)$$

(ideal mixture)

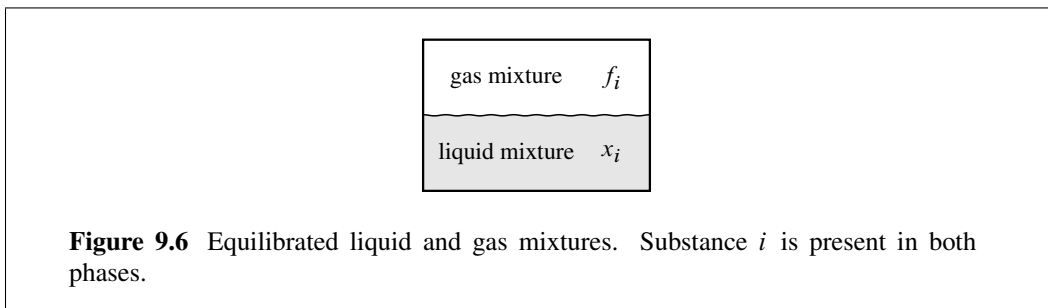

Thus, H_i in an ideal mixture is independent of the mixture composition and is equal to the molar enthalpy of pure i at the same T and p as the mixture. In the case of an ideal gas mixture, H_i is also independent of p , because the molar enthalpy of an ideal gas depends only on T .

The partial molar volume is given by $V_i = (\partial\mu_i/\partial p)_{T,\{n_i\}}$ (Eq. 9.2.49), so we have

$$V_i = \left(\frac{\partial\mu_i^*}{\partial p} \right)_T = V_i^* \quad (9.4.11)$$

(ideal mixture)

Finally, from Eqs. 9.2.50 and 9.2.52 and the expressions above for H_i and V_i , we obtain

$$U_i = H_i^* - pV_i^* = U_i^* \quad (9.4.12)$$

(ideal mixture)

and

$$C_{p,i} = (\partial H_i^*/\partial T)_{p,\{n_i\}} = C_{p,i}^* \quad (9.4.13)$$

(ideal mixture)

Note that in an ideal mixture held at constant T and p , the partial molar quantities H_i , V_i , U_i , and $C_{p,i}$ do not vary with the composition.

9.4.4 Henry's law

Consider the system shown in Fig. 9.6, in which a liquid mixture is equilibrated with a gas phase. Transfer equilibrium exists for substance i , a constituent of both phases. Substance i is assumed to have the same molecular form in both phases, and is not, for instance, an electrolyte. We can vary the mole fraction x_i in the liquid and evaluate the fugacity f_i in the gas phase.

Suppose we allow x_i to approach zero at constant T and p while the relative amounts of the other liquid constituents remain constant. It is found experimentally that the fugacity f_i becomes proportional to x_i :

$$f_i \rightarrow k_{H,i} x_i \quad \text{as} \quad x_i \rightarrow 0 \quad (9.4.14)$$

(constant T and p)

This behavior is called **Henry's law**. The proportionality constant $k_{H,i}$ is the **Henry's law constant** of substance i . The value of $k_{H,i}$ depends on the temperature and the total

BIOGRAPHICAL SKETCH

William Henry (1774–1836)

William Henry was a British chemist, trained as a physician, who is best known for his formulation of what is now called Henry's law.

Henry was born in Manchester, England. His father was an apothecary and industrial chemist who established a profitable business manufacturing such products as magnesium carbonate (used as an antacid) and carbonated water. At the age of ten, Henry was severely injured by a falling beam and was plagued by pain and ill health for the rest of his life.

Henry began medical studies at the University of Edinburgh in 1795. He interrupted these studies to do chemical research, to assist his father in general medical practice, and to help run the family chemical business. He finally received his diploma of Doctor in Medicine in 1807. In 1809, in recognition of his research papers, he was elected a Fellow of the Royal Society.

In 1801 the first edition of his influential chemistry textbook appeared, originally called *An Epitome of Chemistry* and in later editions *Elements of Experimental Chemistry*. The book went through eleven editions over a period of 28 years.

Henry investigated the relation between the pressure of a gas and the volume of the gas, measured at that pressure, that was absorbed into a given volume of water. He used a simple apparatus in which the water and gas were confined over mercury in a graduated glass vessel, and the contents agitated to allow a portion of

the gas to dissolve in the water. His findings were presented to the Royal Society of London in 1802 and published the following year:^a

The results of a series of at least fifty experiments, on carbonic acid, sulphuretted hydrogen gas, nitrous oxide, oxygenous and azotic gases,^b with the above apparatus, establish the following general law: *that, under equal circumstances of temperature, water takes up, in all cases, the same volume of condensed gas as of gas under ordinary pressure. But, as the spaces occupied by every gas are inversely as the compressing force, it follows, that water takes up, of gas condensed by one, two, or more additional atmospheres, a quantity which, ordinarily compressed, would be equal to twice, thrice, &c. the volume absorbed under the common pressure of the atmosphere.*

Henry later confirmed a suggestion made by his close friend John Dalton, that the amount of a constituent of a gaseous mixture that is absorbed is proportional to its *partial* pressure.^c

Henry carried out other important work, chiefly on gases, including the elemental compositions of hydrogen chloride, ammonia, and methane.

Because of his poor health and unsuccessful surgery on his hands, Henry was unable to continue working in the lab after 1824. Twelve years later, suffering from pain and depression, he committed suicide.

In a biography published the year after Henry's death, his son William Charles Henry wrote:^d

In the general intercourse of society, Dr. Henry was distinguished by a polished courtesy, by an intuitive propriety, and by a considerate forethought and respect for the feelings and opinions of others. . . His comprehensive range of thought and knowledge, his proneness to general speculation in contradistinction to detail, his ready command of the refinements of language and the liveliness of his feelings and imagination rendered him a most instructive and engaging companion.

^aRef. [82]. ^bThese gases are respectively CO₂, H₂S, N₂O, O₂, and N₂. ^cRef. [83]. ^dQuoted in Ref. [168].

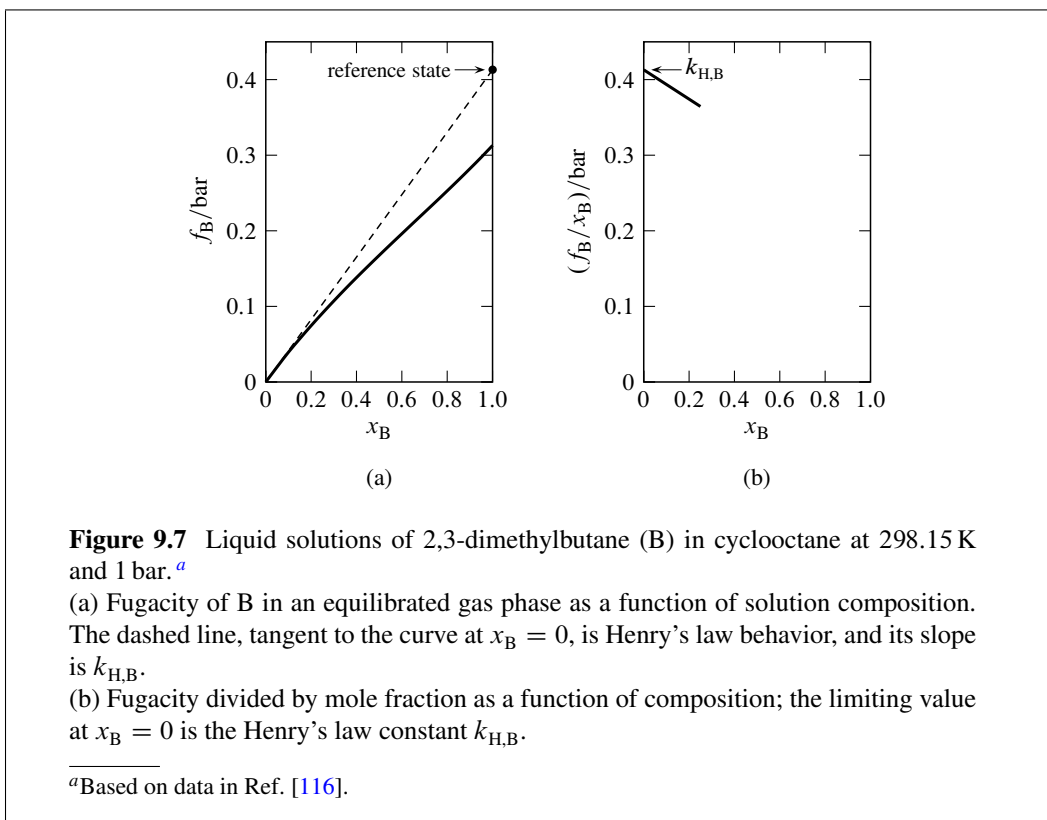

pressure, and also on the relative amounts of the constituents other than i in the liquid mixture.

If the liquid phase happens to be an ideal liquid mixture, then by definition constituent i obeys Raoult's law for fugacity at all values of x_i . In that case, $k_{H,i}$ is equal to f_i^* , the fugacity when the gas phase is equilibrated with pure liquid i at the same temperature and pressure as the liquid mixture.

If we treat the liquid mixture as a binary solution in which solute B is a volatile non-electrolyte, Henry's law behavior occurs in the limit of infinite dilution:

$$f_B \rightarrow k_{H,B} x_B \quad \text{as} \quad x_B \rightarrow 0 \quad (9.4.15)$$

(constant T and p)

An example of this behavior is shown in Fig. 9.7(a). The limiting slope of the plot of f_B versus x_B is finite, not zero or infinite. (The fugacity of a volatile *electrolyte*, such as HCl dissolved in water, displays a much different behavior, as will be shown in Chap. 10.)

Equation 9.4.15 can be applied to a solution of more than one solute if the combination of constituents other than B is treated as the solvent, and the relative amounts of these constituents remain constant as x_B is varied.

Since the mole fraction, concentration, and molality of a solute become proportional to one another in the limit of infinite dilution (Eq. 9.1.14), in a very dilute solution the fugacity is proportional to all three of these composition variables. This leads to three versions of

Henry's law:

$$\text{mole fraction basis} \quad f_B = k_{H,B} x_B \quad (9.4.16)$$

(nonelectrolyte solute
at infinite dilution)

$$\text{concentration basis} \quad f_B = k_{c,B} c_B \quad (9.4.17)$$

(nonelectrolyte solute
at infinite dilution)

$$\text{molality basis} \quad f_B = k_{m,B} m_B \quad (9.4.18)$$

(nonelectrolyte solute
at infinite dilution)

In these equations $k_{H,B}$, $k_{c,B}$, and $k_{m,B}$ are Henry's law constants defined by

$$\text{mole fraction basis} \quad k_{H,B} \stackrel{\text{def}}{=} \lim_{x_B \rightarrow 0} \left(\frac{f_B}{x_B} \right) \quad (9.4.19)$$

$$\text{concentration basis} \quad k_{c,B} \stackrel{\text{def}}{=} \lim_{c_B \rightarrow 0} \left(\frac{f_B}{c_B} \right) \quad (9.4.20)$$

$$\text{molality basis} \quad k_{m,B} \stackrel{\text{def}}{=} \lim_{m_B \rightarrow 0} \left(\frac{f_B}{m_B} \right) \quad (9.4.21)$$

Note that the Henry's law constants are not dimensionless, and are functions of T and p . To evaluate one of these constants, we can plot f_B divided by the appropriate composition variable as a function of the composition variable and extrapolate to infinite dilution. The evaluation of $k_{H,B}$ by this procedure is illustrated in Fig. 9.7(b).

Relations between these Henry's law constants can be found with the use of Eqs. 9.1.14 and 9.4.16–9.4.18:

$$k_{c,B} = V_A^* k_{H,B} \quad k_{m,B} = M_A k_{H,B} \quad (9.4.22)$$

9.4.5 The ideal-dilute solution

An **ideal-dilute solution** is a real solution that is dilute enough for each solute to obey Henry's law. On the microscopic level, the requirement is that solute molecules be sufficiently separated to make solute–solute interactions negligible.

Note that an ideal-dilute solution is not necessarily an ideal mixture. Few liquid mixtures behave as ideal mixtures, but a solution of any nonelectrolyte solute becomes an ideal-dilute solution when sufficiently dilute.

Within the composition range that a solution effectively behaves as an ideal-dilute solution, then, the fugacity of solute B in a gas phase equilibrated with the solution is proportional to its mole fraction x_B in the solution. The chemical potential of B in the gas phase, which is equal to that of B in the liquid, is related to the fugacity by $\mu_B = \mu_B^\circ(g) + RT \ln(f_B/p^\circ)$ (Eq. 9.3.12). Substituting $f_B = k_{H,B} x_B$ (Henry's law) into this equation, we obtain

$$\begin{aligned} \mu_B &= \mu_B^\circ(g) + RT \ln \frac{k_{H,B} x_B}{p^\circ} \\ &= \left[\mu_B^\circ(g) + RT \ln \frac{k_{H,B}}{p^\circ} \right] + RT \ln x_B \end{aligned} \quad (9.4.23)$$

where the composition variable x_B is segregated in the last term on the right side.

The expression in brackets in Eq. 9.4.23 is a function of T and p , but not of x_B , and represents the chemical potential of B in a hypothetical solute reference state. This chemical potential will be denoted by $\mu_{x,B}^{\text{ref}}$, where the x in the subscript reminds us that the reference state is based on mole fraction. The equation then becomes

$$\mu_B(T, p) = \mu_{x,B}^{\text{ref}}(T, p) + RT \ln x_B \quad (9.4.24)$$

(ideal-dilute solution
of a nonelectrolyte)

Here the notation emphasizes the fact that μ_B and $\mu_{x,B}^{\text{ref}}$ are functions of T and p .

Equation 9.4.24, derived using fugacity, is valid even if the solute has such low volatility that its fugacity in an equilibrated gas phase is too low to measure. In principle, no solute is completely nonvolatile, and there is always a finite solute fugacity in the gas phase even if immeasurably small.

It is worthwhile to describe in detail the reference state to which $\mu_{x,B}^{\text{ref}}$ refers. The general concept is also applicable to other solute reference states and solute standard states to be encountered presently. Imagine a hypothetical solution with the same constituents as the real solution. This hypothetical solution has the magical property that it continues to exhibit the ideal-dilute behavior described by Eq. 9.4.24, even when x_B increases beyond the ideal-dilute range of the real solution. The reference state is the state of this hypothetical solution at $x_B=1$. It is a fictitious state in which the mole fraction of B is unity and B behaves as in an ideal-dilute solution, and is sometimes called the *ideal-dilute solution of unit solute mole fraction*.

By setting x_B equal to unity in Eq. 9.4.24, so that $\ln x_B$ is zero, we see that $\mu_{x,B}^{\text{ref}}$ is the chemical potential of B in the reference state. In a gas phase equilibrated with the hypothetical solution, the solute fugacity f_B increases as a linear function of x_B all the way to $x_B=1$, unlike the behavior of the real solution (unless it happens to be an ideal mixture). In the reference state, f_B is equal to the Henry's law constant $k_{H,B}$; an example is indicated by the filled circle in Fig. 9.7(a).

By similar steps, combining Henry's law based on concentration or molality (Eqs. 9.4.17 and 9.4.18) with the relation $\mu_B = \mu_B^\circ(\text{g}) + RT \ln(f_B/p^\circ)$, we obtain for the solute chemical potential in the ideal-dilute range the equations

$$\begin{aligned} \mu_B &= \mu_B^\circ(\text{g}) + RT \ln \left(\frac{k_{c,B} c_B}{p^\circ} \cdot \frac{c^\circ}{c^\circ} \right) \\ &= \left[\mu_B^\circ(\text{g}) + RT \ln \frac{k_{c,B} c^\circ}{p^\circ} \right] + RT \ln \frac{c_B}{c^\circ} \end{aligned} \quad (9.4.25)$$

$$\begin{aligned} \mu_B &= \mu_B^\circ(\text{g}) + RT \ln \left(\frac{k_{m,B} m_B}{p^\circ} \cdot \frac{m^\circ}{m^\circ} \right) \\ &= \left[\mu_B^\circ(\text{g}) + RT \ln \frac{k_{m,B} m^\circ}{p^\circ} \right] + RT \ln \frac{m_B}{m^\circ} \end{aligned} \quad (9.4.26)$$

Note how in each equation the argument of a logarithm is multiplied and divided by a constant, c° or m° , in order to make the arguments of the resulting logarithms dimensionless. These constants are called *standard compositions* with the following values:

standard concentration $c^\circ = 1 \text{ mol dm}^{-3}$ (equal to one mole per liter, or one molar)

standard molality $m^\circ = 1 \text{ mol kg}^{-1}$ (equal to one molal)

Again in each of these equations, we replace the expression in brackets, which depends on T and p but not on composition, with the chemical potential of a solute reference state:

$$\mu_B(T, p) = \mu_{c,B}^{\text{ref}}(T, p) + RT \ln \frac{c_B}{c^\circ} \quad (9.4.27)$$

(ideal-dilute solution
of a nonelectrolyte)

$$\mu_B(T, p) = \mu_{m,B}^{\text{ref}}(T, p) + RT \ln \frac{m_B}{m^\circ} \quad (9.4.28)$$

(ideal-dilute solution
of a nonelectrolyte)

The quantities $\mu_{c,B}^{\text{ref}}$ and $\mu_{m,B}^{\text{ref}}$ are the chemical potentials of the solute in hypothetical reference states that are solutions of standard concentration and standard molality, respectively, in which B behaves as in an ideal-dilute solution. Section 9.7.1 will show that when the pressure is the standard pressure, these reference states are solute *standard* states.

For consistency with Eqs. 9.4.27 and 9.4.28, we can rewrite Eq. 9.4.24 in the form

$$\mu_B(T, p) = \mu_{x,B}^{\text{ref}}(T, p) + RT \ln \frac{x_B}{x^\circ} \quad (9.4.29)$$

with x° , the **standard mole fraction**, given by $x^\circ = 1$.

9.4.6 Solvent behavior in the ideal-dilute solution

We now use the Gibbs–Duhem equation to investigate the behavior of the solvent in an ideal-dilute solution of one or more nonelectrolyte solutes. The Gibbs–Duhem equation applied to chemical potentials at constant T and p can be written $\sum_i x_i d\mu_i = 0$ (Eq. 9.2.43). We use subscript A for the solvent, rewrite the equation as $x_A d\mu_A + \sum_{i \neq A} x_i d\mu_i = 0$, and rearrange to

$$d\mu_A = -\frac{1}{x_A} \sum_{i \neq A} x_i d\mu_i \quad (9.4.30)$$

(constant T and p)

This equation shows how changes in the solute chemical potentials, due to a composition change at constant T and p , affect the chemical potential of the solvent.

In an ideal-dilute solution, the chemical potential of each solute is given by $\mu_i = \mu_{x,i}^{\text{ref}} + RT \ln x_i$ and the differential of μ_i at constant T and p is

$$d\mu_i = RT d \ln x_i = RT dx_i/x_i \quad (9.4.31)$$

(Here the fact has been used that $\mu_{x,i}^{\text{ref}}$ is a constant at a given T and p .) When we substitute this expression for $d\mu_i$ in Eq. 9.4.30, we obtain

$$d\mu_A = -\frac{RT}{x_A} \sum_{i \neq A} dx_i \quad (9.4.32)$$

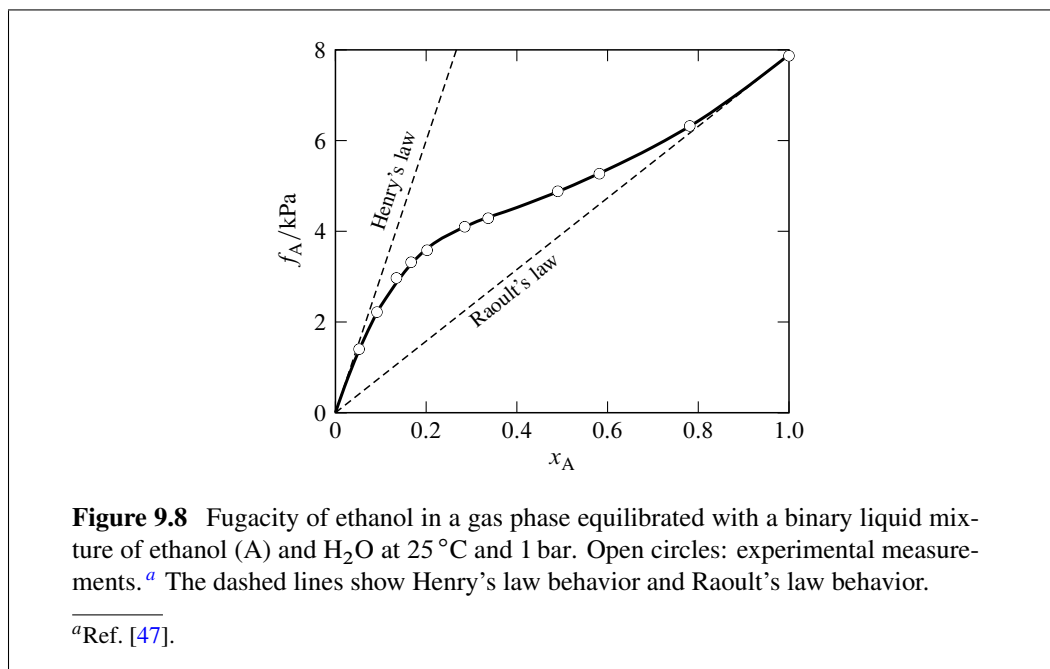

Now since the sum of all mole fractions is 1, we have the relation $\sum_{i \neq A} x_i = 1 - x_A$ whose differential is $\sum_{i \neq A} dx_i = -dx_A$. Making this substitution in Eq. 9.4.32 gives us

$$d\mu_A = \frac{RT}{x_A} dx_A = RT d \ln x_A \quad (9.4.33)$$

(ideal-dilute solution
of nonelectrolytes)

Consider a process in an open system in which we start with a fixed amount of pure solvent and continuously add the solute or solutes at constant T and p . The solvent mole fraction decreases from unity to a value x'_A , and the solvent chemical potential changes from μ_A^* to μ'_A . We assume the solution formed in this process is in the ideal-dilute solution range, and integrate Eq. 9.4.33 over the path of the process:

$$\int_{\mu_A^*}^{\mu'_A} d\mu_A = RT \int_{x_A=1}^{x_A=x'_A} d \ln x_A \quad (9.4.34)$$

The result is $\mu'_A - \mu_A^* = RT \ln x'_A$, or in general

$$\mu_A = \mu_A^* + RT \ln x_A \quad (9.4.35)$$

Comparison with Eq. 9.4.5 on page 249 shows that Eq. 9.4.35 is equivalent to Raoult's law for fugacity.

Thus, in an ideal-dilute solution of nonelectrolytes *each solute obeys Henry's law and the solvent obeys Raoult's law*.

An equivalent statement is that a nonelectrolyte constituent of a liquid mixture approaches Henry's law behavior as its mole fraction approaches zero, and approaches Raoult's law behavior as its mole fraction approaches unity. This is illustrated in Fig. 9.8, which shows the behavior of ethanol in ethanol-water mixtures. The ethanol exhibits positive deviations from Raoult's law and negative deviations from Henry's law.

Table 9.2 Partial molar quantities of solvent and nonelectrolyte solute in an ideal-dilute solution

Solvent	Solute
$\mu_A = \mu_A^* + RT \ln x_A$	$\mu_B = \mu_{x,B}^{\text{ref}} + RT \ln x_B$ $= \mu_{c,B}^{\text{ref}} + RT \ln(c_B/c^\circ)$ $= \mu_{m,B}^{\text{ref}} + RT \ln(m_B/m^\circ)$
$S_A = S_A^* - R \ln x_A$	$S_B = S_{x,B}^{\text{ref}} - R \ln x_B$ $= S_{c,B}^{\text{ref}} - R \ln(c_B/c^\circ)$ $= S_{m,B}^{\text{ref}} - R \ln(m_B/m^\circ)$
$H_A = H_A^*$	$H_B = H_B^\infty$
$V_A = V_A^*$	$V_B = V_B^\infty$
$U_A = U_A^*$	$U_B = U_B^\infty$
$C_{p,A} = C_{p,A}^*$	$C_{p,B} = C_{p,B}^\infty$

9.4.7 Partial molar quantities in an ideal-dilute solution

Consider the *solvent*, A, of a solution that is dilute enough to be in the ideal-dilute range. In this range, the solvent fugacity obeys Raoult's law, and the partial molar quantities of the solvent are the same as those in an ideal mixture. Formulas for these quantities were given in Eqs. 9.4.8–9.4.13 and are collected in the first column of Table 9.2. The formulas show that the chemical potential and partial molar entropy of the solvent, at constant T and p , vary with the solution composition and, in the limit of infinite dilution ($x_A \rightarrow 1$), approach the values for the pure solvent. The partial molar enthalpy, volume, internal energy, and heat capacity, on the other hand, are independent of composition in the ideal-dilute region and are equal to the corresponding molar quantities for the pure solvent.

Next consider a *solute*, B, of a binary ideal-dilute solution. The solute obeys Henry's law, and its chemical potential is given by $\mu_B = \mu_{x,B}^{\text{ref}} + RT \ln x_B$ (Eq. 9.4.24) where $\mu_{x,B}^{\text{ref}}$ is a function of T and p , but not of composition. μ_B varies with the composition and goes to $-\infty$ as the solution becomes infinitely dilute ($x_A \rightarrow 1$ and $x_B \rightarrow 0$).

For the partial molar entropy of the solute, we use $S_B = -(\partial\mu_B/\partial T)_{p,\{n_i\}}$ (Eq. 9.2.48) and obtain

$$S_B = -\left(\frac{\partial\mu_{x,B}^{\text{ref}}}{\partial T}\right)_p - R \ln x_B \quad (9.4.36)$$

The term $-(\partial\mu_{x,B}^{\text{ref}}/\partial T)_p$ represents the partial molar entropy $S_{x,B}^{\text{ref}}$ of B in the fictitious reference state of unit solute mole fraction. Thus, we can write Eq. 9.4.36 in the form

$$S_B = S_{x,B}^{\text{ref}} - R \ln x_B \quad (9.4.37)$$

(ideal-dilute solution
of a nonelectrolyte)

This equation shows that the partial molar entropy varies with composition and goes to $+\infty$ in the limit of infinite dilution. From the expressions of Eqs. 9.4.27 and 9.4.28, we can derive similar expressions for S_B in terms of the solute reference states on a concentration or molality basis.

The relation $H_B = \mu_B + TS_B$ (from Eq. 9.2.46), combined with Eqs. 9.4.24 and 9.4.37, yields

$$H_B = \mu_{x,B}^{\text{ref}} + TS_{x,B}^{\text{ref}} = H_{x,B}^{\text{ref}} \quad (9.4.38)$$

showing that at constant T and p , the partial molar enthalpy of the solute is constant throughout the ideal-dilute solution range. Therefore, we can write

$$H_B = H_B^\infty \quad (9.4.39)$$

(ideal-dilute solution
of a nonelectrolyte)

where H_B^∞ is the partial molar enthalpy at infinite dilution. By similar reasoning, using Eqs. 9.2.49–9.2.52, we find that the partial molar volume, internal energy, and heat capacity of the solute are constant in the ideal-dilute range and equal to the values at infinite dilution. The expressions are listed in the second column of Table 9.2.

When the pressure is equal to the standard pressure p° , the quantities H_B^∞ , V_B^∞ , U_B^∞ , and $C_{p,B}^\infty$ are the same as the standard values H_B° , V_B° , U_B° , and $C_{p,B}^\circ$.

9.5 Activity Coefficients in Mixtures of Nonelectrolytes

An *activity coefficient* of a species is a kind of adjustment factor that relates the actual behavior to ideal behavior at the same temperature and pressure. The ideal behavior is based on a *reference state* for the species.

We begin by describing reference states for nonelectrolytes. The thermodynamic behavior of an electrolyte solution is more complicated than that of a mixture of nonelectrolytes, and will be discussed in the next chapter.

9.5.1 Reference states and standard states

A *reference state* of a constituent of a mixture has the same temperature and pressure as the mixture. When species i is in its reference state, its chemical potential μ_i^{ref} depends only on the temperature and pressure of the mixture.

If the pressure is the standard pressure p° , the reference state of species i becomes its *standard state*. In the standard state, the chemical potential is the *standard chemical potential* μ_i° , which is a function only of temperature.

Reference states are useful for derivations involving processes taking place at constant T and p when the pressure is not necessarily the standard pressure.

Table 9.3 on the next page describes the reference states of nonelectrolytes used in this book, and lists symbols for chemical potentials of substances in these states. The symbols for solutes include x , c , or m in the subscript to indicate the basis of the reference state.

9.5.2 Ideal mixtures

Since the activity coefficient of a species relates its actual behavior to its ideal behavior at the same T and p , let us begin by examining behavior in ideal mixtures.

Consider first an ideal gas mixture at pressure p . The chemical potential of substance i in this ideal gas mixture is given by Eq. 9.3.5 (the superscript “id” stands for ideal):

$$\mu_i^{\text{id}}(\text{g}) = \mu_i^\circ(\text{g}) + RT \ln \frac{p_i}{p^\circ} \quad (9.5.1)$$

Table 9.3 Reference states for nonelectrolyte constituents of mixtures. In each reference state, the temperature and pressure are the same as those of the mixture.

Constituent	Reference state	Chemical potential
Substance i in a gas mixture	Pure i behaving as an ideal gas ^a	$\mu_i^{\text{ref}}(\text{g})$
Substance i in a liquid or solid mixture	Pure i in the same physical state as the mixture	μ_i^*
Solvent A of a solution	Pure A in the same physical state as the solution	μ_A^*
Solute B, mole fraction basis	B at mole fraction 1, behavior extrapolated from infinite dilution on a mole fraction basis ^a	$\mu_{x,B}^{\text{ref}}$
Solute B, concentration basis	B at concentration c° , behavior extrapolated from infinite dilution on a concentration basis ^a	$\mu_{c,B}^{\text{ref}}$
Solute B, molality basis	B at molality m° , behavior extrapolated from infinite dilution on a molality basis ^a	$\mu_{m,B}^{\text{ref}}$

^aA hypothetical state.

The reference state of gaseous substance i is pure i acting as an ideal gas at pressure p . Its chemical potential is given by

$$\mu_i^{\text{ref}}(\text{g}) = \mu_i^\circ(\text{g}) + RT \ln \frac{p}{p^\circ} \quad (9.5.2)$$

Subtracting Eq. 9.5.2 from Eq. 9.5.1, we obtain

$$\mu_i^{\text{id}}(\text{g}) - \mu_i^{\text{ref}}(\text{g}) = RT \ln \frac{p_i}{p} \quad (9.5.3)$$

Consider the following expressions for chemical potentials in ideal mixtures and ideal-dilute solutions of nonelectrolytes. The first equation is a rearrangement of Eq. 9.5.3, and the others are from earlier sections of this chapter.⁷

$$\text{Constituent of an ideal gas mixture} \quad \mu_i^{\text{id}}(\text{g}) = \mu_i^{\text{ref}}(\text{g}) + RT \ln \frac{p_i}{p} \quad (9.5.4)$$

$$\text{Constituent of an ideal liquid or solid mixture} \quad \mu_i^{\text{id}} = \mu_i^* + RT \ln x_i \quad (9.5.5)$$

$$\text{Solvent of an ideal-dilute solution} \quad \mu_A^{\text{id}} = \mu_A^* + RT \ln x_A \quad (9.5.6)$$

$$\text{Solute, ideal-dilute solution, mole fraction basis} \quad \mu_B^{\text{id}} = \mu_{x,B}^{\text{ref}} + RT \ln x_B \quad (9.5.7)$$

$$\text{Solute, ideal-dilute solution, concentration basis} \quad \mu_B^{\text{id}} = \mu_{c,B}^{\text{ref}} + RT \ln \frac{c_B}{c^\circ} \quad (9.5.8)$$

$$\text{Solute, ideal-dilute solution, molality basis} \quad \mu_B^{\text{id}} = \mu_{m,B}^{\text{ref}} + RT \ln \frac{m_B}{m^\circ} \quad (9.5.9)$$

Note that the equations for the condensed phases have the general form

$$\mu_i^{\text{id}} = \mu_i^{\text{ref}} + RT \ln \left(\frac{\text{composition variable}}{\text{standard composition}} \right) \quad (9.5.10)$$

⁷In order of occurrence, Eqs. 9.4.8, 9.4.35, 9.4.24, 9.4.27, and 9.4.28.

where μ_i^{ref} is the chemical potential of component i in an appropriate reference state. (The standard composition on a mole fraction basis is $x^\circ = 1$.)

9.5.3 Real mixtures

If a mixture is *not* ideal, we can write an expression for the chemical potential of each component that includes an **activity coefficient**. The expression is like one of those for the ideal case (Eqs. 9.5.4–9.5.9) with the activity coefficient multiplying the quantity within the logarithm.

Consider constituent i of a gas mixture. If we eliminate $\mu_i^\circ(\text{g})$ from Eqs. 9.3.12 and 9.5.2, we obtain

$$\begin{aligned}\mu_i &= \mu_i^{\text{ref}}(\text{g}) + RT \ln \frac{f_i}{p} \\ &= \mu_i^{\text{ref}}(\text{g}) + RT \ln \frac{\phi_i p_i}{p}\end{aligned}\quad (9.5.11)$$

where f_i is the fugacity of constituent i and ϕ_i is its fugacity coefficient. Here the activity coefficient is the fugacity coefficient ϕ_i .

For components of a condensed-phase mixture, we write expressions for the chemical potential having a form similar to that in Eq. 9.5.10, with the composition variable now multiplied by an activity coefficient:

$$\mu_i = \mu_i^{\text{ref}} + RT \ln \left[(\text{activity coefficient of } i) \times \left(\frac{\text{composition variable}}{\text{standard composition}} \right) \right] \quad (9.5.12)$$

The activity coefficient of a species is a dimensionless quantity whose value depends on the temperature, the pressure, the mixture composition, and the choice of the reference state for the species. Under conditions in which the mixture behaves ideally, the activity coefficient is unity and the chemical potential is given by one of the expressions of Eqs. 9.5.4–9.5.9; otherwise, the activity coefficient has the value that gives the actual chemical potential.

This book will use various symbols for activity coefficients, as indicated in the following list of expressions for the chemical potentials of nonelectrolytes:

$$\text{Constituent of a gas mixture} \quad \mu_i = \mu_i^{\text{ref}}(\text{g}) + RT \ln \left(\phi_i \frac{p_i}{p} \right) \quad (9.5.13)$$

$$\text{Constituent of a liquid or solid mixture} \quad \mu_i = \mu_i^* + RT \ln (\gamma_i x_i) \quad (9.5.14)$$

$$\text{Solvent of a solution} \quad \mu_A = \mu_A^* + RT \ln (\gamma_A x_A) \quad (9.5.15)$$

$$\text{Solute of a solution, mole fraction basis} \quad \mu_B = \mu_{x,B}^{\text{ref}} + RT \ln (\gamma_{x,B} x_B) \quad (9.5.16)$$

$$\text{Solute of a solution, concentration basis} \quad \mu_B = \mu_{c,B}^{\text{ref}} + RT \ln \left(\gamma_{c,B} \frac{c_B}{c^\circ} \right) \quad (9.5.17)$$

$$\text{Solute of a solution, molality basis} \quad \mu_B = \mu_{m,B}^{\text{ref}} + RT \ln \left(\gamma_{m,B} \frac{m_B}{m^\circ} \right) \quad (9.5.18)$$

Equation 9.5.14 refers to a component of a liquid or solid mixture of substances that mix in all proportions. Equation 9.5.15 refers to the solvent of a solution. The reference states of these components are the pure liquid or solid at the temperature and pressure of the mixture. For the activity coefficients of these components, this book uses the symbols γ_i and γ_A .

The IUPAC Green Book (Ref. [36], p. 59) recommends the symbol f_i for the activity coefficient of component i when the reference state is the pure liquid or solid. This book instead uses symbols such as γ_i and γ_A , in order to avoid confusion with the symbol usually used for fugacity, f_i .

In Eqs. 9.5.16–9.5.18, the symbols $\gamma_{x,B}$, $\gamma_{c,B}$, and $\gamma_{m,B}$ for activity coefficients of a nonelectrolyte solute include x , c , or m in the subscript to indicate the choice of the solute reference state. Although three different expressions for μ_B are shown, for a given solution composition they must all represent the same *value* of μ_B , equal to the rate at which the Gibbs energy increases with the amount of substance B added to the solution at constant T and p . The value of a solute activity coefficient, on the other hand, depends on the choice of the solute reference state.

You may find it helpful to interpret products appearing on the right sides of Eqs. 9.5.13–9.5.18 as follows.

- $\phi_i p_i$ is an effective partial pressure.
- $\gamma_i x_i$, $\gamma_A x_A$, and $\gamma_{x,B} x_B$ are effective mole fractions.
- $\gamma_{c,B} c_B$ is an effective concentration.
- $\gamma_{m,B} m_B$ is an effective molality.

In other words, the value of one of these products is the value of a partial pressure or composition variable that would give the same chemical potential in an ideal mixture as the actual chemical potential in the real mixture. These effective composition variables are an alternative way to express the escaping tendency of a substance from a phase; they are related exponentially to the chemical potential, which is also a measure of escaping tendency.

A change in pressure or composition that causes a mixture to approach the behavior of an ideal mixture or ideal-dilute solution must cause the activity coefficient of each mixture constituent to approach unity:

$$\text{Constituent of a gas mixture} \quad \phi_i \rightarrow 1 \quad \text{as} \quad p \rightarrow 0 \quad (9.5.19)$$

$$\text{Constituent of a liquid or solid mixture} \quad \gamma_i \rightarrow 1 \quad \text{as} \quad x_i \rightarrow 1 \quad (9.5.20)$$

$$\text{Solvent of a solution} \quad \gamma_A \rightarrow 1 \quad \text{as} \quad x_A \rightarrow 1 \quad (9.5.21)$$

$$\text{Solute of a solution, mole fraction basis} \quad \gamma_{x,B} \rightarrow 1 \quad \text{as} \quad x_B \rightarrow 0 \quad (9.5.22)$$

$$\text{Solute of a solution, concentration basis} \quad \gamma_{c,B} \rightarrow 1 \quad \text{as} \quad c_B \rightarrow 0 \quad (9.5.23)$$

$$\text{Solute of a solution, molality basis} \quad \gamma_{m,B} \rightarrow 1 \quad \text{as} \quad m_B \rightarrow 0 \quad (9.5.24)$$

9.5.4 Nonideal dilute solutions

How would we expect the activity coefficient of a nonelectrolyte solute to behave in a dilute solution as the solute mole fraction increases beyond the range of ideal-dilute solution behavior?

The following argument is based on molecular properties at constant T and p .

We focus our attention on a single solute molecule. This molecule has interactions with nearby solute molecules. Each interaction depends on the intermolecular distance and causes a change in the internal energy compared to the interaction of the

solute molecule with solvent at the same distance.⁸ The number of solute molecules in a volume element at a given distance from the solute molecule we are focusing on is proportional to the local solute concentration. If the solution is dilute and the interactions weak, we expect the local solute concentration to be proportional to the macroscopic solute mole fraction. Thus, the partial molar quantities U_B and V_B of the solute should be approximately linear functions of x_B in a dilute solution at constant T and p .

From Eqs. 9.2.46 and 9.2.50, the solute chemical potential is given by $\mu_B = U_B + pV_B - TS_B$. In the dilute solution, we assume U_B and V_B are linear functions of x_B as explained above. We also assume the dependence of S_B on x_B is approximately the same as in an ideal mixture; this is a prediction from statistical mechanics for a mixture in which all molecules have similar sizes and shapes. Thus we expect the deviation of the chemical potential from ideal-dilute behavior, $\mu_B = \mu_{x,B}^{\text{ref}} + RT \ln x_B$, can be described by adding a term proportional to x_B : $\mu_B = \mu_{x,B}^{\text{ref}} + RT \ln x_B + k_x x_B$, where k_x is a positive or negative constant related to solute-solute interactions.

If we equate this expression for μ_B with the one that defines the activity coefficient, $\mu_B = \mu_{x,B}^{\text{ref}} + RT \ln(\gamma_{x,B} x_B)$ (Eq. 9.5.16), and solve for the activity coefficient, we obtain the relation⁹ $\gamma_{x,B} = \exp(k_x x_B / RT)$. An expansion of the exponential in powers of x_B converts this to

$$\gamma_{x,B} = 1 + (k_x / RT)x_B + \dots \quad (9.5.25)$$

Thus we predict that at constant T and p , $\gamma_{x,B}$ is a linear function of x_B at low x_B . An ideal-dilute solution, then, is one in which x_B is much smaller than RT/k_x so that $\gamma_{x,B}$ is approximately 1. An ideal mixture requires the interaction constant k_x to be zero.

By similar reasoning, we reach analogous conclusions for solute activity coefficients on a concentration or molality basis. For instance, at low m_B the chemical potential of B should be approximately $\mu_{m,B}^{\text{ref}} + RT \ln(m_B/m^\circ) + k_m m_B$, where k_m is a constant at a given T and p ; then the activity coefficient at low m_B is given by

$$\gamma_{m,B} = \exp(k_m m_B / RT) = 1 + (k_m / RT)m_B + \dots \quad (9.5.26)$$

The prediction from the theoretical argument above, that a solute activity coefficient in a dilute solution is a linear function of the composition variable, is borne out experimentally as illustrated in Fig. 9.10 on page 266. This prediction applies only to a nonelectrolyte solute; for an electrolyte, the slope of activity coefficient versus molality approaches $-\infty$ at low molality (page 292).

9.6 Evaluation of Activity Coefficients

This section describes several methods by which activity coefficients of nonelectrolyte substances may be evaluated. Section 9.6.3 describes an osmotic coefficient method that is also suitable for electrolyte solutes, as will be explained in Sec. 10.6.

⁸In Sec. 11.1.5, it will be shown that roughly speaking the internal energy change is negative if the average of the attractive forces between two solute molecules and two solvent molecules is greater than the attractive force between a solute molecule and a solvent molecule at the same distance, and is positive for the opposite situation. ⁹This is essentially the result of the McMillan–Mayer solution theory from statistical mechanics.

9.6.1 Activity coefficients from gas fugacities

Suppose we equilibrate a liquid mixture with a gas phase. If component i of the liquid mixture is a volatile nonelectrolyte, and we are able to evaluate its fugacity f_i in the gas phase, we have a convenient way to evaluate the activity coefficient γ_i in the liquid. The relation between γ_i and f_i will now be derived.

When component i is in transfer equilibrium between two phases, its chemical potential is the same in both phases. Equating expressions for μ_i in the liquid mixture and the equilibrated gas phase (from Eqs. 9.5.14 and 9.5.11, respectively), and then solving for γ_i , we have

$$\mu_i^* + RT \ln(\gamma_i x_i) = \mu_i^{\text{ref}}(\text{g}) + RT \ln(f_i/p) \quad (9.6.1)$$

$$\gamma_i = \exp\left[\frac{\mu_i^{\text{ref}}(\text{g}) - \mu_i^*}{RT}\right] \times \frac{f_i}{x_i p} \quad (9.6.2)$$

On the right side of Eq. 9.6.2, only f_i and x_i depend on the liquid composition. We can therefore write

$$\gamma_i = C_i \frac{f_i}{x_i} \quad (9.6.3)$$

where C_i is a factor whose value depends on T and p , but not on the liquid composition. Solving Eq. 9.6.3 for C_i gives $C_i = \gamma_i x_i / f_i$.

Now consider Eq. 9.5.20 on page 262. It says that as x_i approaches 1 at constant T and p , γ_i also approaches 1. We can use this limit to evaluate C_i :

$$C_i = \lim_{x_i \rightarrow 1} \frac{\gamma_i x_i}{f_i} = \frac{1}{f_i^*} \quad (9.6.4)$$

Here f_i^* is the fugacity of i in a gas phase equilibrated with pure liquid i at the temperature and pressure of the mixture. Then substitution of this value of C_i (which is independent of x_i) in Eq. 9.6.3 gives us an expression for γ_i at any liquid composition:

$$\gamma_i = \frac{f_i}{x_i f_i^*} \quad (9.6.5)$$

We can follow the same procedure for a solvent or solute of a liquid solution. We replace the left side of Eq. 9.6.1 with an expression from among Eqs. 9.5.15–9.5.18, then derive an expression analogous to Eq. 9.6.3 for the activity coefficient with a composition-independent factor, and finally apply the limiting conditions that cause the activity coefficient to approach unity (Eqs. 9.5.21–9.5.24) and allow us to evaluate the factor. When we take the limits that cause the solute activity coefficients to approach unity, the ratios f_B/x_B , f_B/c_B , and f_B/m_B become Henry's law constants (Eqs. 9.4.19–9.4.21). The resulting expressions for activity coefficients as functions of fugacity are listed in Table 9.4 on the next page.

Examples

Ethanol and water at 25 °C mix in all proportions, so we can treat the liquid phase as a liquid mixture rather than a solution. A plot of ethanol fugacity versus mole fraction at fixed T and p , shown earlier in Fig. 9.8, is repeated in Fig. 9.9(a) on the next page. Ethanol

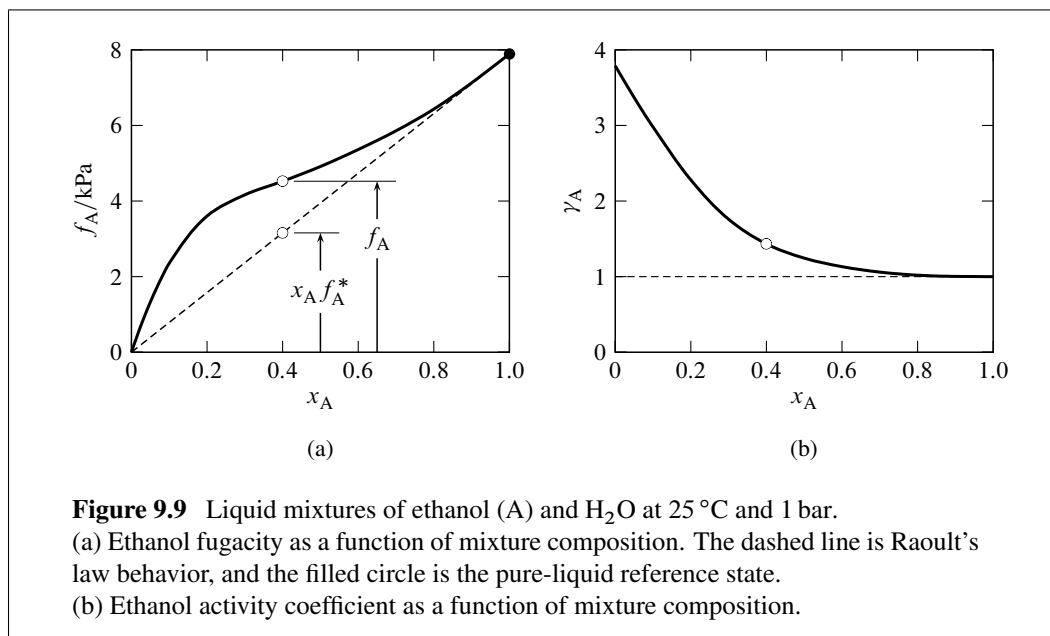
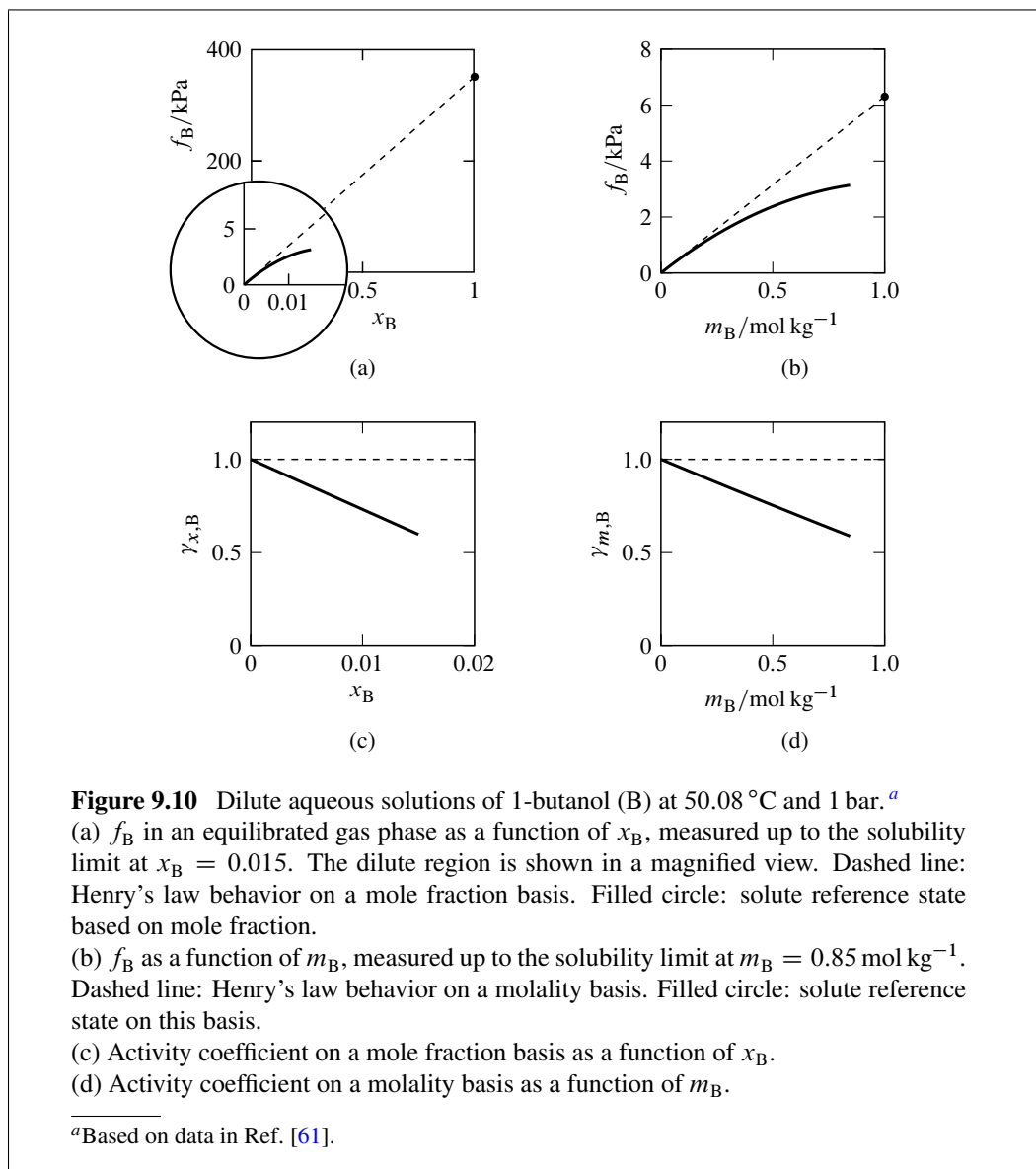

Table 9.4 Activity coefficients as functions of fugacity. For a constituent of a condensed-phase mixture, f_i , f_A , and f_B refer to the fugacity in a gas phase equilibrated with the condensed phase.

Substance	Activity coefficient
Substance i in a gas mixture	$\phi_i = \frac{f_i}{p_i}$
Substance i in a liquid or solid mixture	$\gamma_i = \frac{f_i}{x_i f_i^*}$
Solvent A of a solution	$\gamma_A = \frac{f_A}{x_A f_A^*}$
Solute B, mole fraction basis	$\gamma_{x,B} = \frac{f_B}{k_{H,B} x_B}$
Solute B, concentration basis	$\gamma_{c,B} = \frac{f_B}{k_{c,B} c_B}$
Solute B, molality basis	$\gamma_{m,B} = \frac{f_B}{k_{m,B} m_B}$

is component A. In the figure, the filled circle is the pure-liquid reference state at $x_A=1$ where f_A is equal to f_A^* . The open circles at $x_A = 0.4$ indicate f_A , the actual fugacity in a gas phase equilibrated with a liquid mixture of this composition, and $x_A f_A^*$, the fugacity the ethanol would have if the mixture were ideal and component A obeyed Raoult's law. The ratio of these two quantities is the activity coefficient γ_A .

Figure 9.9(b) shows how γ_A varies with composition. The open circle is at $x_A = 0.4$ and $\gamma_A = f_A/(x_A f_A^*)$. Note how γ_A approaches 1 as x_A approaches 1, as it must according to Eq. 9.5.20.



Water and 1-butanol are two liquids that do not mix in all proportions; that is, 1-butanol has limited solubility in water. Figures 9.10(a) and 9.10(b) show the fugacity of 1-butanol plotted as functions of both mole fraction and molality. The figures demonstrate how, treating 1-butanol as a solute, we locate the solute reference state by a linear extrapolation of the fugacity to the standard composition. The fugacity f_B is quite different in the two reference states. At the reference state indicated by a filled circle in Fig. 9.10(a), f_B equals the Henry's law constant $k_{H,B}$; at the reference state in Fig. 9.10(b), f_B equals $k_{m,B}m^\circ$. Note how the activity coefficients plotted in Figs. 9.10(c) and 9.10(d) approach 1 at infinite dilution, in agreement with Eqs. 9.5.22 and 9.5.24, and how they vary as a linear function of x_B or m_B in the dilute solution as predicted by the theoretical argument of Sec. 9.5.4.

9.6.2 Activity coefficients from the Gibbs–Duhem equation

If component B of a binary liquid mixture has low volatility, it is not practical to use its fugacity in a gas phase to evaluate its activity coefficient. If, however, component A is volatile enough for fugacity measurements over a range of liquid composition, we can instead use the Gibbs–Duhem equation for this purpose.

Consider a binary mixture of two liquids that mix in all proportions. We assume that only component A is appreciably volatile. By measuring the fugacity of A in a gas phase equilibrated with the binary mixture, we can evaluate its activity coefficient based on a pure-liquid reference state: $\gamma_A = f_A/(x_A f_A^*)$ (Table 9.4). We wish to use the same fugacity measurements to determine the activity coefficient of the nonvolatile component, B.

The Gibbs–Duhem equation for a binary liquid mixture in the form given by Eq. 9.2.43 is

$$x_A d\mu_A + x_B d\mu_B = 0 \quad (9.6.6)$$

where $d\mu_A$ and $d\mu_B$ are the chemical potential changes accompanying a change of composition at constant T and p . Taking the differential at constant T and p of $\mu_A = \mu_A^* + RT \ln(\gamma_A x_A)$ (Eq. 9.5.14), we obtain

$$d\mu_A = RT d \ln \gamma_A + RT d \ln x_A = RT d \ln \gamma_A + \frac{RT}{x_A} dx_A \quad (9.6.7)$$

For component B, we obtain in the same way

$$d\mu_B = RT d \ln \gamma_B + \frac{RT}{x_B} dx_B = RT d \ln \gamma_B - \frac{RT}{x_B} dx_A \quad (9.6.8)$$

Substituting these expressions for $d\mu_A$ and $d\mu_B$ in Eq. 9.6.6 and solving for $d \ln \gamma_B$, we obtain the following relation:

$$d \ln \gamma_B = -\frac{x_A}{x_B} d \ln \gamma_A \quad (9.6.9)$$

Integration from $x_B = 1$, where γ_B equals 1 and $\ln \gamma_B$ equals 0, to composition x'_B gives

$$\ln \gamma_B(x'_B) = - \int_{x_B=1}^{x_B=x'_B} \frac{x_A}{x_B} d \ln \gamma_A \quad (9.6.10)$$

(binary mixture,
constant T and p)

Equation 9.6.10 allows us to evaluate the activity coefficient of the nonvolatile component, B, at any given liquid composition from knowledge of the activity coefficient of the volatile component A as a function of composition.

Next consider a binary liquid mixture in which component B is neither volatile nor able to mix in all proportions with A. In this case, it is appropriate to treat B as a solute and to base its activity coefficient on a solute reference state. We could obtain an expression for $\ln \gamma_{x,B}$ similar to Eq. 9.6.10, but the integration would have to start at $x_B=0$ where the integrand x_A/x_B would be infinite. Instead, it is convenient in this case to use the method described in the next section.

9.6.3 Activity coefficients from osmotic coefficients

It is customary to evaluate the activity coefficient of a nonvolatile solute with a function ϕ_m called the **osmotic coefficient**, or osmotic coefficient on a molality basis. The osmotic coefficient of a solution of nonelectrolyte solutes is defined by

$$\phi_m \stackrel{\text{def}}{=} \frac{\mu_A^* - \mu_A}{RTM_A \sum_{i \neq A} m_i} \quad (\text{nonelectrolyte solution}) \quad (9.6.11)$$

The definition of ϕ_m in Eq. 9.6.11 has the following significance. The sum $\sum_{i \neq A} m_i$ is the total molality of all solute species. In an ideal-dilute solution, the solvent chemical potential is $\mu_A = \mu_A^* + RT \ln x_A$. The expansion of the function $\ln x_A$ in powers of $(1 - x_A)$ gives the power series $\ln x_A = -(1 - x_A) - (1 - x_A)^2/2 - (1 - x_A)^3/3 - \dots$. Thus, in a very dilute solution we have $\ln x_A \approx -(1 - x_A) = -\sum_{i \neq A} x_i$. In the limit of infinite dilution, the mole fraction of solute i becomes $x_i = M_A m_i$ (see Eq. 9.1.14). In the limit of infinite dilution, therefore, we have

$$\ln x_A = -M_A \sum_{i \neq A} m_i \quad (\text{infinite dilution}) \quad (9.6.12)$$

and the solvent chemical potential is related to solute molalities by

$$\mu_A = \mu_A^* - RTM_A \sum_{i \neq A} m_i \quad (\text{infinite dilution}) \quad (9.6.13)$$

The deviation of ϕ_m from unity is a measure of the deviation of μ_A from infinite-dilution behavior, as we can see by comparing the preceding equation with a rearrangement of Eq. 9.6.11:

$$\mu_A = \mu_A^* - \phi_m RTM_A \sum_{i \neq A} m_i \quad (9.6.14)$$

The reason ϕ_m is called the osmotic coefficient has to do with its relation to the osmotic pressure Π of the solution: The ratio Π/m_B is equal to the product of ϕ_m and the limiting value of Π/m_B at infinite dilution (see Sec. 12.4.4).

Evaluation of ϕ_m

Any method that measures $\mu_A^* - \mu_A$, the lowering of the solvent chemical potential caused by the presence of a solute or solutes, allows us to evaluate ϕ_m through Eq. 9.6.11.

The chemical potential of the solvent in a solution is related to the fugacity in an equilibrated gas phase by $\mu_A = \mu_A^{\text{ref}}(\text{g}) + RT \ln(f_A/p)$ (from Eq. 9.5.11). For the pure solvent, this relation is $\mu_A^* = \mu_A^{\text{ref}}(\text{g}) + RT \ln(f_A^*/p)$. Taking the difference between these two equations, we obtain

$$\mu_A^* - \mu_A = RT \ln \frac{f_A^*}{f_A} \quad (9.6.15)$$

which allows us to evaluate ϕ_m from fugacity measurements.

Osmotic coefficients can also be evaluated from freezing point and osmotic pressure measurements that will be described in Sec. 12.2.

Use of ϕ_m

Suppose we have a solution of a nonelectrolyte solute B whose activity coefficient $\gamma_{m,B}$ we wish to evaluate as a function of m_B . For a binary solution, Eq. 9.6.11 becomes

$$\phi_m = \frac{\mu_A^* - \mu_A}{RTM_A m_B} \quad (9.6.16)$$

(binary nonelectrolyte solution)

Solving for μ_A and taking its differential at constant T and p , we obtain

$$d\mu_A = -RTM_A d(\phi_m m_B) = -RTM_A (\phi_m dm_B + m_B d\phi_m) \quad (9.6.17)$$

From $\mu_B = \mu_{m,B}^{\text{ref}} + RT \ln(\gamma_{m,B} m_B / m^\circ)$ (Eq. 9.5.18), we obtain

$$d\mu_B = RT d \ln \frac{\gamma_{m,B} m_B}{m^\circ} = RT \left(d \ln \gamma_{m,B} + \frac{dm_B}{m_B} \right) \quad (9.6.18)$$

We substitute these expressions for $d\mu_A$ and $d\mu_B$ in the Gibbs–Duhem equation in the form given by Eq. 9.2.26, $n_A d\mu_A + n_B d\mu_B = 0$, make the substitution $n_A M_A = n_B / m_B$, and rearrange to

$$d \ln \gamma_{m,B} = d\phi_m + \frac{\phi_m - 1}{m_B} dm_B \quad (9.6.19)$$

We integrate both sides of this equation for a composition change at constant T and p from $m_B = 0$ (where $\ln x_B$ is 0 and ϕ_m is 1) to any desired molality m'_B , with the result

$$\ln \gamma_{m,B}(m'_B) = \phi_m(m'_B) - 1 + \int_0^{m'_B} \frac{\phi_m - 1}{m_B} dm_B \quad (9.6.20)$$

(binary nonelectrolyte solution)

When the solute is a nonelectrolyte, the integrand $(\phi_m - 1)/m_B$ is found to be a slowly varying function of m_B and to approach a finite value as m_B approaches zero.

Once ϕ_m has been measured as a function of molality from zero up to the molality of interest, Eq. 9.6.20 can be used to evaluate the solute activity coefficient $\gamma_{m,B}$ at that molality.

Figure 9.11(a) on the next page shows the function $(\phi_m - 1)/m_B$ for aqueous sucrose solutions over a wide range of molality. The dependence of the solute activity coefficient on molality, generated from Eq. 9.6.20, is shown in Fig. 9.11(b). Figure 9.11(c) is a plot of the effective sucrose molality $\gamma_{m,B} m_B$ as a function of composition. Note how the activity coefficient becomes greater than unity beyond the ideal-dilute region, and how in consequence the effective molality $\gamma_{m,B} m_B$ becomes considerably greater than the actual molality m_B .

9.6.4 Fugacity measurements

Section 9.6.1 described the evaluation of the activity coefficient of a constituent of a liquid mixture from its fugacity in a gas phase equilibrated with the mixture. Section 9.6.3 mentioned the use of solvent fugacities in gas phases equilibrated with pure solvent and with a solution, in order to evaluate the osmotic coefficient of the solution.

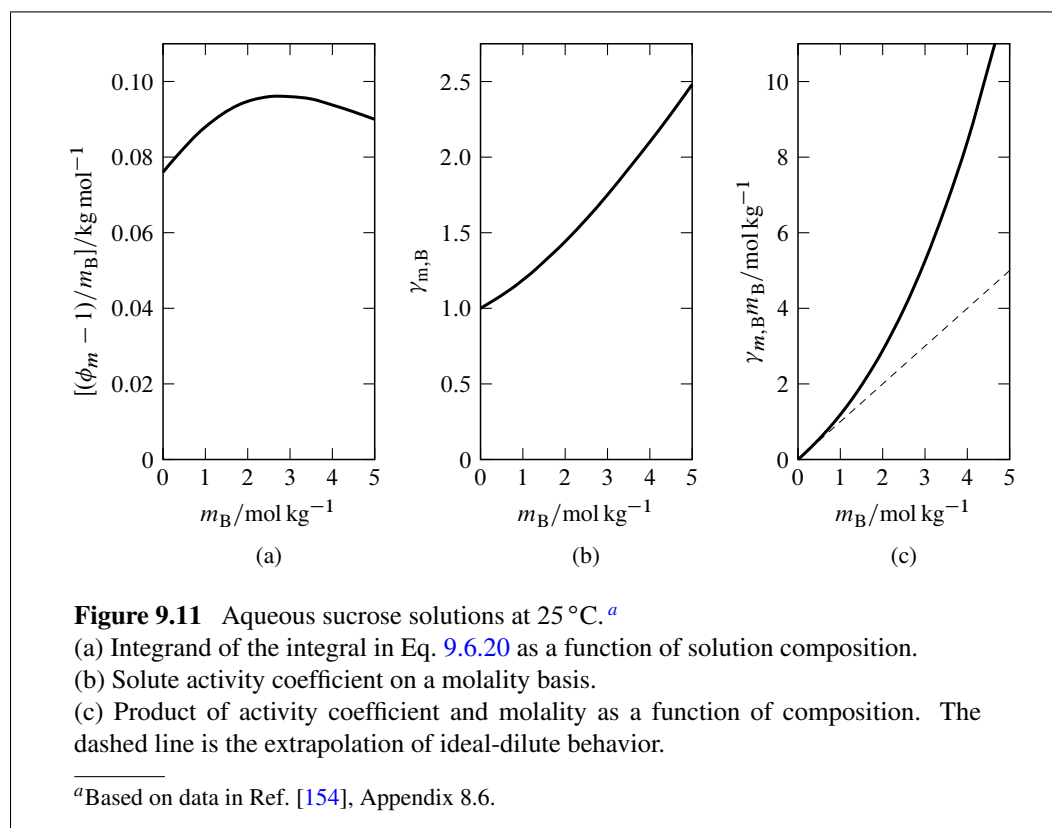

Various experimental methods are available for measuring a partial pressure in a gas phase equilibrated with a liquid mixture. A correction for gas nonideality, such as that given by Eq. 9.3.16, can be used to convert the partial pressure to fugacity.

If the solute of a solution is nonvolatile, we may pump out the air above the solution and use a manometer to measure the pressure, which is the partial pressure of the solvent. Dynamic methods involve passing a stream of inert gas through a liquid mixture and analyzing the gas mixture to evaluate the partial pressures of volatile components. For instance, we could pass dry air successively through an aqueous solution and a desiccant and measure the weight gained by the desiccant.

The **isopiestic vapor pressure technique** is one of the most useful methods for determining the fugacity of H₂O in a gas phase equilibrated with an aqueous solution. This is a comparative method using a binary solution of the solute of interest, B, and a nonvolatile reference solute of known properties. Some commonly used reference solutes for which data are available are sucrose, NaCl, and CaCl₂.

In this method, solute B can be either a nonelectrolyte or electrolyte. Dishes, each containing water and an accurately weighed sample of one of the solutes, are placed in wells drilled in a block made of metal for good thermal equilibration. The assembly is placed in a gas-tight chamber, the air is evacuated, and the apparatus is gently rocked in a thermostat for a period of up to several days, or even weeks. During this period, H₂O is transferred among the dishes through the vapor space until the chemical potential of the water becomes the same in each solution. The solutions are then said to be *isopiestic*. Finally, the dishes are removed from the apparatus and weighed to establish the molality of each solution. The

H₂O fugacity is known as a function of the molality of the reference solute, and is the same as the H₂O fugacity in equilibrium with the solution of solute B at its measured molality.

The isopiestic vapor pressure method can also be used for nonaqueous solutions.

9.7 Activity of an Uncharged Species

The **activity** a_i of uncharged species i (i.e., a substance) is defined by the relation

$$a_i \stackrel{\text{def}}{=} \exp\left(\frac{\mu_i - \mu_i^\circ}{RT}\right) \quad (9.7.1)$$

(uncharged species)

or

$$\mu_i = \mu_i^\circ + RT \ln a_i \quad (9.7.2)$$

(uncharged species)

where μ_i° is the standard chemical potential of the species.¹⁰ The activity of a species in a given phase is a dimensionless quantity whose value depends on the choice of the standard state and on the intensive properties of the phase: temperature, pressure, and composition.

The quantity a_i is sometimes called the *relative activity* of i , because it depends on the chemical potential relative to a standard chemical potential. An important application of the activity concept is the definition of equilibrium constants (Sec. 11.8.1).

For convenience in later applications, we specify that the value of a_i is the same in phases that have the same temperature, pressure, and composition but are at different elevations in a gravitational field, or are at different electric potentials. Section 9.8 10.1 will describe a modification of the defining equation $\mu_i = \mu_i^\circ + RT \ln a_i$ for a system with phases of different elevations, and Sec. 10.1 will describe the modification needed for a charged species.

9.7.1 Standard states

The standard states of different kinds of mixture components have the same definitions as those for reference states (Table 9.3), with the additional stipulation in each case that the pressure is equal to the standard pressure p° .

When component i is in its standard state, its chemical potential is the standard chemical potential μ_i° . It is important to note from Eq. 9.7.2 that when μ_i equals μ_i° , the logarithm of a_i is zero and the activity in the standard state is therefore unity.

The following equations in the form of Eq. 9.7.2 show the notation used in this book for the standard chemical potentials and activities of various kinds of uncharged mixture

¹⁰Some chemists define the activity by $\mu_i = \mu_i^{\text{ref}} + RT \ln a_i$. The activity defined this way is not the same as the activity used in this book unless the phase is at the standard pressure.

BIOGRAPHICAL SKETCH
Gilbert Newton Lewis (1875–1946)

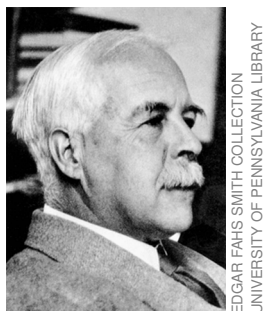

Gilbert Lewis made major contributions to several fields of physical chemistry. He was born in Weymouth, Massachusetts. His father was a lawyer and banker.

Lewis was reserved, even shy in front of a large audience. He was also ambitious, had great personal charm, excelled at both experimental and theoretical thermodynamics, and was a chain smoker of vile Manila cigars.

Lewis considered himself to be a disciple of Willard Gibbs. After completing his Ph.D dissertation at Harvard University in 1899, he published several papers of thermodynamic theory that introduced for the first time the terms fugacity (1901) and activity (1907). The first of these papers was entitled “A New Conception of Thermal Pressure and a Theory of Solutions” and began:^a

For an understanding of all kinds of physico-chemical equilibrium a further insight is necessary into the nature of the conditions which exist in the interior of any homogeneous phase. It will be the aim of the present paper to study this problem in the light of a new theory, which, although opposed to some ideas which are now accepted as correct, yet recommends itself by its simplicity and by its ability to explain several important phenomena which have hitherto received no satisfactory explanation.

His first faculty position (1905-1912) was at Boston Tech, now the Massachusetts Institute of Technology, where he continued work in one of his dissertation subjects: the measurement of standard electrode potentials in order to determine standard molar Gibbs energies of

formation of substances and ions.

In 1912 he became the chair of the chemistry department at the University of California at Berkeley, which he turned into a renowned center of chemical research and teaching. In 1916 he published his theory of the shared electron-pair chemical bond (Lewis structures), a concept he had been thinking about since at least 1902. In the course of measuring the thermodynamic properties of electrolyte solutions, he introduced the concept of ionic strength (1921).

In 1923, at age 48, he consolidated his knowledge of thermodynamics in the great classic *Thermodynamics and the Free Energy of Chemical Substances*^b with Merle Randall as coauthor. After that his interests changed to other subjects. He was the first to prepare pure deuterium and D₂O (1933), he formulated his generalized definitions of acids and bases (Lewis acids and bases, 1938), and at the time of his death he was doing research on photochemical processes.

Lewis was nominated 35 times for the Nobel prize, but was never awarded it. According to a history of modern chemistry published in 2008,^c Wilhelm Palmaer, a Swedish electrochemist, used his position on the Nobel Committee for Chemistry to block the award to Lewis. Palmaer was a close friend of Walther Nernst, whom Lewis had criticized on the basis of occasional “arithmetic and thermodynamic inaccuracy.”^d

His career was summarized by his last graduate student, Michael Kasha, as follows:^e

Gilbert Lewis once defined physical chemistry as encompassing “everything that is interesting.” His own career touched virtually every aspect of science, and in each he left his mark. He is justly regarded as one of the key scientists in American history. It would be a great omission not to record the warmth and intellectual curiosity radiated by Lewis’ personality. He epitomized the scientist of unlimited imagination, and the joy of working with him was to experience the life of the mind unhindered by pedestrian concerns.

^aRef. [109]. ^bRef. [110]. ^cRef. [35], Chap. 7. ^dRef. [110], page 6. ^eRef. [92].

components:

$$\text{Substance } i \text{ in a gas mixture} \quad \mu_i = \mu_i^\circ(\text{g}) + RT \ln a_i(\text{g}) \quad (9.7.3)$$

$$\text{Substance } i \text{ in a liquid or solid mixture} \quad \mu_i = \mu_i^\circ + RT \ln a_i \quad (9.7.4)$$

$$\text{Solvent A of a solution} \quad \mu_A = \mu_A^\circ + RT \ln a_A \quad (9.7.5)$$

$$\text{Solute B, mole fraction basis} \quad \mu_B = \mu_{x,B}^\circ + RT \ln a_{x,B} \quad (9.7.6)$$

$$\text{Solute B, concentration basis} \quad \mu_B = \mu_{c,B}^\circ + RT \ln a_{c,B} \quad (9.7.7)$$

$$\text{Solute B, molality basis} \quad \mu_B = \mu_{m,B}^\circ + RT \ln a_{m,B} \quad (9.7.8)$$

9.7.2 Activities and composition

We need to be able to relate the activity of component i to the mixture composition. We can do this by finding the relation between the chemical potential of component i in its reference state and in its standard state, both at the same temperature. These two chemical potentials, μ_i^{ref} and μ_i° , are equal only if the mixture is at the standard pressure p° .

It will be useful to define the following dimensionless quantity:

$$\Gamma_i \stackrel{\text{def}}{=} \exp\left(\frac{\mu_i^{\text{ref}} - \mu_i^\circ}{RT}\right) \quad (9.7.9)$$

The symbol Γ_i for this quantity was introduced by Pitzer and Brewer.¹¹ They called it *the activity in a reference state*. To see why, compare the definition of activity given by $\mu_i = \mu_i^\circ + RT \ln a_i$ with a rearrangement of Eq. 9.7.9: $\mu_i^{\text{ref}} = \mu_i^\circ + RT \ln \Gamma_i$.

At a given temperature, the difference $\mu_i^{\text{ref}} - \mu_i^\circ$ depends only on the pressure p of the mixture, and is zero when p is equal to p° . Thus Γ_i is a function of p with a value of 1 when p is equal to p° . This book will call Γ_i the **pressure factor** of species i .

To understand how activity is related to composition, let us take as an example the activity $a_{m,B}$ of solute B based on molality. From Eqs. 9.5.18 and 9.7.8, we have

$$\begin{aligned} \mu_B &= \mu_{m,B}^{\text{ref}} + RT \ln\left(\gamma_{m,B} \frac{m_B}{m^\circ}\right) \\ &= \mu_{m,B}^\circ + RT \ln a_{m,B} \end{aligned} \quad (9.7.10)$$

The activity is then given by

$$\begin{aligned} \ln a_{m,B} &= \frac{\mu_{m,B}^{\text{ref}} - \mu_{m,B}^\circ}{RT} + \ln\left(\gamma_{m,B} \frac{m_B}{m^\circ}\right) \\ &= \ln \Gamma_{m,B} + \ln\left(\gamma_{m,B} \frac{m_B}{m^\circ}\right) \end{aligned} \quad (9.7.11)$$

$$a_{m,B} = \Gamma_{m,B} \gamma_{m,B} \frac{m_B}{m^\circ} \quad (9.7.12)$$

The activity of a constituent of a condensed-phase mixture is in general equal to the product of the pressure factor, the activity coefficient, and the composition variable divided by the standard composition.

Table 9.5 on the next page gives explicit expressions for the activities of various kinds of nonelectrolyte substances.

¹¹Ref. [111], p. 249.

Table 9.5 Expressions for activities of nonelectrolytes. For a constituent of a condensed-phase mixture, f_i , f_A , and f_B refer to the fugacity in a gas phase equilibrated with the condensed phase.

Substance	Activity
Pure gas	$a(\text{g}) = \Gamma(\text{g}) \phi = \frac{f}{p^\circ}$
Pure liquid or solid	$a = \Gamma$
Substance i in a gas mixture	$a_i(\text{g}) = \Gamma_i(\text{g}) \phi_i \frac{p_i}{p} = \frac{f_i}{p^\circ}$
Substance i in a liquid or solid mixture	$a_i = \Gamma_i \gamma_i x_i = \Gamma_i \frac{f_i}{f_i^*}$
Solvent A of a solution	$a_A = \Gamma_A \gamma_A x_A = \Gamma_A \frac{f_A}{f_A^*}$
Solute B, mole fraction basis	$a_{x,B} = \Gamma_{x,B} \gamma_{x,B} x_B = \Gamma_{x,B} \frac{f_B}{k_{H,B}}$
Solute B, concentration basis	$a_{c,B} = \Gamma_{c,B} \gamma_{c,B} \frac{c_B}{c^\circ} = \Gamma_{c,B} \frac{f_B}{k_{c,B} c^\circ}$
Solute B, molality basis	$a_{m,B} = \Gamma_{m,B} \gamma_{m,B} \frac{m_B}{m^\circ} = \Gamma_{m,B} \frac{f_B}{k_{m,B} m^\circ}$

9.7.3 Pressure factors and pressure

At a given temperature, the pressure factor Γ_i of component i of a mixture is a function only of pressure. To derive the pressure dependence of Γ_i for various kinds of mixture components, we need expressions for $(\mu_i^{\text{ref}} - \mu_i^\circ)$ as functions of pressure to substitute in the defining equation $\Gamma_i = \exp[(\mu_i^{\text{ref}} - \mu_i^\circ)/RT]$.

For component i of a *gas mixture*, the reference state is pure gas i at the pressure of the mixture, behaving as an ideal gas. The chemical potential of a pure ideal gas depends on its pressure according to Eq. 7.8.6: $\mu = \mu^\circ(\text{g}) + RT \ln(p/p^\circ)$. Thus the chemical potential of the reference state of gas component i is $\mu_i^{\text{ref}}(\text{g}) = \mu_i^\circ(\text{g}) + RT \ln(p/p^\circ)$, and $\mu_i^{\text{ref}}(\text{g}) - \mu_i^\circ(\text{g})$ is equal to $RT \ln(p/p^\circ)$. This gives us the following expression for the pressure dependence of the pressure factor:

$$\Gamma_i(\text{g}) = \frac{p}{p^\circ} \quad (9.7.13)$$

For a mixture in a *condensed phase*, we will make use of $(\partial\mu_i/\partial p)_{T,\{n_i\}} = V_i$ (Eq. 9.2.49). The relation between changes of μ_i and p at constant temperature and composition is therefore $d\mu_i = V_i dp$. Recall (Sec. 9.1.5) that “constant composition” means that the mole fraction or molality of each component, but not necessarily the concentration, is constant.

Consider a process in which the system initially consists of a phase with component i in its standard state. We change the pressure isothermally from p° to the pressure p' of the mixture of interest. For a pure-liquid, pure-solid, or solvent reference state, or a solute reference state based on mole fraction or molality, this process brings the system to the

reference state of component i at pressure p' . The change of μ_i in this case is given by integration of $d\mu_i = V_i dp$:

$$\mu_i^{\text{ref}}(p') - \mu_i^\circ = \int_{p^\circ}^{p'} V_i dp \quad (9.7.14)$$

The appropriate partial molar volume V_i is the molar volume V_i^* or V_A^* of the pure substance, or the partial molar volume V_B^∞ of solute B at infinite dilution.

Suppose we want to use a reference state for solute B based on concentration. Because the isothermal pressure change involves a small change of volume, c_B changes slightly during the process, so that the right side of Eq. 9.7.14 is not quite the correct expression for $\mu_{c,B}^{\text{ref}}(p') - \mu_{c,B}^\circ$.

We can derive a rigorous expression for $\mu_{c,B}^{\text{ref}}(p') - \mu_{c,B}^\circ$ as follows. Consider an ideal-dilute solution of solute B at an arbitrary pressure p , with solute chemical potential given by $\mu_B = \mu_{c,B}^{\text{ref}} + RT \ln(c_B/c^\circ)$ (Table 9.2). From this equation we obtain

$$\left(\frac{\partial \mu_B}{\partial p}\right)_{T,\{n_i\}} = \left(\frac{\partial \mu_{c,B}^{\text{ref}}}{\partial p}\right)_T + RT \left[\frac{\partial \ln(c_B/c^\circ)}{\partial p}\right]_{T,\{n_i\}} \quad (9.7.15)$$

The partial derivative $(\partial \mu_B / \partial p)_{T,\{n_i\}}$ is equal to the partial molar volume V_B (Eq. 9.2.49), which in the ideal-dilute solution has its infinite-dilution value V_B^∞ . We rewrite the second partial derivative on the right side of Eq. 9.7.15 as follows:

$$\begin{aligned} \left[\frac{\partial \ln(c_B/c^\circ)}{\partial p}\right]_{T,\{n_i\}} &= \frac{1}{c_B} \left(\frac{\partial c_B}{\partial p}\right)_{T,\{n_i\}} = \frac{1}{n_B/V} \left[\frac{\partial (n_B/V)}{\partial p}\right]_{T,\{n_i\}} \\ &= V \left[\frac{\partial (1/V)}{\partial p}\right]_{T,\{n_i\}} = -\frac{1}{V} \left(\frac{\partial V}{\partial p}\right)_{T,\{n_i\}} \\ &= \kappa_T \end{aligned} \quad (9.7.16)$$

Here κ_T is the isothermal compressibility of the solution, which at infinite dilution is κ_T^∞ , the isothermal compressibility of the pure solvent. Equation 9.7.15 becomes

$$V_B^\infty = \left(\frac{\partial \mu_{c,B}^{\text{ref}}}{\partial p}\right)_T + RT \kappa_T^\infty \quad (9.7.17)$$

Solving for $d\mu_{c,B}^{\text{ref}}$ at constant T , and integrating from p° to p' , we obtain finally

$$\mu_{c,B}^{\text{ref}}(p') - \mu_{c,B}^\circ = \int_{p^\circ}^{p'} (V_B^\infty - RT \kappa_T^\infty) dp \quad (9.7.18)$$

We are now able to write explicit formulas for Γ_i for each kind of mixture component. They are collected in Table 9.6 on the next page.

Considering a constituent of a condensed-phase mixture, by how much is the pressure factor likely to differ from unity? If we use the values $p^\circ = 1$ bar and $T = 300$ K, and assume the molar volume of pure i is $V_i^* = 100 \text{ cm}^3 \text{ mol}^{-1}$ at all pressures, we find that Γ_i is 0.996 in the limit of zero pressure, unity at 1 bar, 1.004 at 2 bar, 1.04 at 10 bar, and 1.49 at 100 bar. For a solution with $V_B^\infty = 100 \text{ cm}^3 \text{ mol}^{-1}$, we obtain the same values as these for $\Gamma_{x,B}$, $\Gamma_{m,B}$, and $\Gamma_{c,B}$. These values demonstrate that it is only at high pressures that the pressure factor differs appreciably from unity. For this reason, it is common to see expressions for activity in which this factor is omitted: $a_i = \gamma_i x_i$, $a_{m,B} = \gamma_{m,B} m_B / m^\circ$, and so on.

Table 9.6 Expressions for the dependence of pressure factors of nonelectrolytes on pressure. The approximate expressions assume the phase is incompressible, or the solute partial molar volume is independent of pressure.

Substance	Pressure factor at pressure p'
Substance i in a gas mixture, or the pure gas	$\Gamma_i(\text{g}) = \frac{p'}{p^\circ}$
Substance i in a liquid or solid mixture, or the pure liquid or solid	$\Gamma_i = \exp\left(\int_{p^\circ}^{p'} \frac{V_i^*}{RT} dp\right) \approx \exp\left[\frac{V_i^*(p' - p^\circ)}{RT}\right]$
Solvent A of a solution	$\Gamma_A = \exp\left(\int_{p^\circ}^{p'} \frac{V_A^*}{RT} dp\right) \approx \exp\left[\frac{V_A^*(p' - p^\circ)}{RT}\right]$
Solute B, mole fraction or molality basis	$\Gamma_{x,B} = \Gamma_{m,B} = \exp\left(\int_{p^\circ}^{p'} \frac{V_B^\infty}{RT} dp\right) \approx \exp\left[\frac{V_B^\infty(p' - p^\circ)}{RT}\right]$
Solute B, concentration basis	$\Gamma_{c,B} = \exp\left[\int_{p^\circ}^{p'} \left(\frac{V_B^\infty}{RT} - \kappa_T^\infty\right) dp\right] \approx \exp\left[\frac{V_B^\infty(p' - p^\circ)}{RT}\right]$

In principle, we can specify any convenient value for the standard pressure p° . For a chemist making measurements at high pressures, it would be convenient to specify a value of p° within the range of the experimental pressures, for example $p^\circ = 1$ kbar, in order that the value of each pressure factor be close to unity.

9.8 Mixtures in Gravitational and Centrifugal Fields

A tall column of a gas mixture in a gravitational field, and a liquid solution in the cell of a spinning centrifuge rotor, are systems with equilibrium states that are nonuniform in pressure and composition. This section derives the ways in which pressure and composition vary spatially within these kinds of systems at equilibrium.

9.8.1 Gas mixture in a gravitational field

Consider a tall column of a gas mixture in an earth-fixed lab frame. Our treatment will parallel that for a tall column of a pure gas in Sec. 8.1.4. We imagine the gas to be divided into many thin slab-shaped phases at different elevations in a rigid container, as in Fig. 8.1 on page 198. We want to find the equilibrium conditions reached spontaneously when the system is isolated from its surroundings.

The derivation is the same as that in Sec. 9.2.7, with the additional constraint that for each phase α , dV^α is zero in order that each phase stays at a constant elevation. The result is the relation

$$dS = \sum_{\alpha \neq \alpha'} \frac{T^{\alpha'} - T^\alpha}{T^{\alpha'}} dS^\alpha + \sum_i \sum_{\alpha \neq \alpha'} \frac{\mu_i^{\alpha'} - \mu_i^\alpha}{T^{\alpha'}} dn_i^\alpha \quad (9.8.1)$$

In an equilibrium state, S is at a maximum and dS is zero for an infinitesimal change of any of the independent variables. This requires the coefficient of each term in the sums on

the right side of Eq. 9.8.1 to be zero. The equation therefore tells that at equilibrium *the temperature and the chemical potential of each constituent are uniform throughout the gas mixture*. The equation says nothing about the pressure.

Just as the chemical potential of a pure substance at a given elevation is defined in this book as the molar Gibbs energy at that elevation (page 199), the chemical potential of substance i in a mixture at elevation h is the partial molar Gibbs energy at that elevation.

We define the standard potential $\mu_i^\circ(\text{g})$ of component i of the gas mixture as the chemical potential of i under standard state conditions at the reference elevation $h=0$. At this elevation, the chemical potential and fugacity are related by

$$\mu_i(0) = \mu_i^\circ(\text{g}) + RT \ln \frac{f_i(0)}{p^\circ} \quad (9.8.2)$$

If we reversibly raise a small sample of mass m of the gas mixture by an infinitesimal distance dh , without heat and at constant T and V , the fugacity f_i remains constant. The gravitational work during the elevation process is $\delta w' = mg dh$. This work contributes to the internal energy change: $dU = T dS - p dV + \sum_i \mu_i dn_i + mg dh$. The total differential of the Gibbs energy of the sample is

$$\begin{aligned} dG &= d(U - TS + pV) \\ &= -S dT + V dp + \sum_i \mu_i dn_i + mg dh \end{aligned} \quad (9.8.3)$$

From this total differential, we write the reciprocity relation

$$\left(\frac{\partial \mu_i}{\partial h} \right)_{T,p,\{n_i\}} = \left(\frac{\partial mg}{\partial n_i} \right)_{T,p,n_{j \neq i},h} \quad (9.8.4)$$

With the substitution $m = \sum_i n_i M_i$ in the partial derivative on the right side, the partial derivative becomes $M_i g$. At constant T , p , and composition, therefore, we have $d\mu_i = M_i g dh$. Integrating over a finite elevation change from $h = 0$ to $h = h'$, we obtain

$$\mu_i(h') - \mu_i(0) = \int_0^{h'} M_i g dh = M_i g h' \quad (9.8.5)$$

$(f_i(h') = f_i(0))$

The general relation between μ_i , f_i , and h that agrees with Eqs. 9.8.2 and 9.8.5 is

$$\mu_i(h) = \mu_i^\circ(\text{g}) + RT \ln \frac{f_i(h)}{p^\circ} + M_i g h \quad (9.8.6)$$

In the equilibrium state of the tall column of gas, $\mu_i(h)$ is equal to $\mu_i(0)$. Equation 9.8.6 shows that this is only possible if f_i decreases as h increases. Equating the expressions given by this equation for $\mu_i(h)$ and $\mu_i(0)$, we have

$$\mu_i^\circ(\text{g}) + RT \ln \frac{f_i(h)}{p^\circ} + M_i g h = \mu_i^\circ(\text{g}) + RT \ln \frac{f_i(0)}{p^\circ} \quad (9.8.7)$$

Solving for $f_i(h)$ gives

$$f_i(h) = f_i(0) e^{-M_i g h / RT} \quad (9.8.8)$$

(gas mixture at equilibrium)

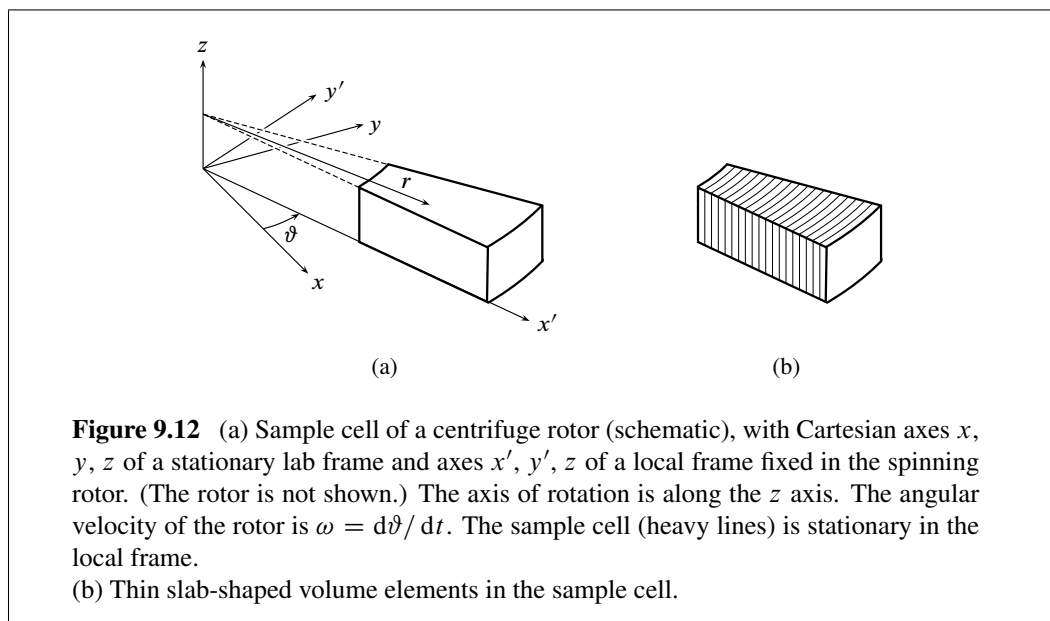

If the gas is an ideal gas mixture, f_i is the same as the partial pressure p_i :

$$p_i(h) = p_i(0)e^{-M_i g h / RT} \quad (9.8.9)$$

(ideal gas mixture at equilibrium)

Equation 9.8.9 shows that each constituent of an ideal gas mixture individually obeys the barometric formula given by Eq. 8.1.13 on page 199.

The pressure at elevation h is found from $p(h) = \sum_i p_i(h)$. If the constituents have different molar masses, the mole fraction composition changes with elevation. For example, in a binary ideal gas mixture the mole fraction of the constituent with the greater molar mass decreases with increasing elevation, and the mole fraction of the other constituent increases.

9.8.2 Liquid solution in a centrifuge cell

This section derives equilibrium conditions of a dilute binary solution confined to a cell embedded in a spinning centrifuge rotor.

The *system* is the solution. The rotor's angle of rotation with respect to a lab frame is not relevant to the state of the system, so we use a local reference frame fixed in the rotor as shown in Fig. 9.12(a). The values of heat, work, and energy changes measured in this rotating frame are different from those in a lab frame (Sec. G.9 in Appendix G). Nevertheless, the laws of thermodynamics and the relations derived from them are obeyed in the local frame when we measure the heat, work, and state functions in this frame (page 498).

Note that an equilibrium state can only exist relative to the rotating local frame; an observer fixed in this frame would see no change in the state of the isolated solution over time. While the rotor rotates, however, there is no equilibrium state relative to the lab frame, because the system's position in the frame constantly changes.

We assume the centrifuge rotor rotates about the vertical z axis at a constant angular velocity ω . As shown in Fig. 9.12(a), the elevation of a point within the local frame is given by z and the radial distance from the axis of rotation is given by r .

In the rotating local frame, a body of mass m has exerted on it a centrifugal force $F^{\text{centr}} = m\omega^2 r$ directed horizontally in the outward $+r$ radial direction (Sec. G.9).¹² The gravitational force in this frame, directed in the downward $-z$ direction, is the same as the gravitational force in a lab frame. Because the height of a typical centrifuge cell is usually no greater than about one centimeter, in an equilibrium state the variation of pressure and composition between the top and bottom of the cell at any given distance from the axis of rotation is completely negligible—all the measurable variation is along the radial direction.

To find conditions for equilibrium, we imagine the solution to be divided into many thin curved volume elements at different distances from the axis of rotation as depicted in Fig. 9.12(b). We treat each volume element as a uniform phase held at constant volume so that it is at a constant distance from the axis of rotation. The derivation is the same as the one used in the preceding section to obtain Eq. 9.8.1, and leads to the same conclusion: in an equilibrium state *the temperature and the chemical potential of each substance (solvent and solute) are uniform throughout the solution.*

We find the dependence of pressure on r as follows. Consider one of the thin slab-shaped volume elements of Fig. 9.12(b). The volume element is located at radial position r and its faces are perpendicular to the direction of increasing r . The thickness of the volume element is δr , the surface area of each face is A_s , and the mass of the solution in the volume element is $m = \rho A_s \delta r$. Expressed as components in the direction of increasing r of the forces exerted on the volume element, the force at the inner face is pA_s , the force at the outer face is $-(p + \delta p)A_s$, and the centrifugal force is $m\omega^2 r = \rho A_s \omega^2 r \delta r$. From Newton's second law, the sum of these components is zero at equilibrium:

$$pA_s - (p + \delta p)A_s + \rho A_s \omega^2 r \delta r = 0 \quad (9.8.10)$$

or $\delta p = \rho \omega^2 r \delta r$. In the limit as δr and δp are made infinitesimal, this becomes

$$dp = \rho \omega^2 r dr \quad (9.8.11)$$

We will assume the density ρ is uniform throughout the solution.¹³ Then integration of Eq. 9.8.11 yields

$$p'' - p' = \int_{p'}^{p''} dp = \rho \omega^2 \int_{r'}^{r''} r dr = \frac{\rho \omega^2}{2} [(r'')^2 - (r')^2] \quad (9.8.12)$$

where the superscripts $'$ and $''$ denote positions at two different values of r in the cell. The pressure is seen to increase with increasing distance from the axis of rotation.

Next we investigate the dependence of the solute concentration c_B on r in the equilibrium state of the binary solution. Consider a small sample of the solution of mass m . Assume the extent of this sample in the radial direction is small enough for the variation of

¹²There is also a Coriolis force that vanishes as the body's velocity in the rotating local frame approaches zero. The centrifugal and Coriolis forces are *apparent* or *fictitious* forces, in the sense that they are caused by the acceleration of the rotating frame rather than by interactions between particles. When we treat these forces as if they are real forces, we can use Newton's second law of motion to relate the net force on a body and the body's acceleration in the rotating frame (see Sec. G.6). ¹³In the centrifugal field, this assumption is strictly true only if the solution is incompressible and its density is independent of composition.

the centrifugal force field to be negligible. The reversible work in the local frame needed to move this small sample an infinitesimal distance dr at constant z , T , and p , using an external force $-F^{\text{centr}}$ that opposes the centrifugal force, is

$$\delta w' = F^{\text{sur}} dr = (-F^{\text{centr}}) dr = -m\omega^2 r dr \quad (9.8.13)$$

This work is a contribution to the change dU of the internal energy. The Gibbs energy of the small sample in the local frame is a function of the independent variables T , p , n_A , n_B , and r , and its total differential is

$$\begin{aligned} dG &= d(U - TS + pV) \\ &= -S dT + V dp + \mu_A dn_A + \mu_B dn_B - m\omega^2 r dr \end{aligned} \quad (9.8.14)$$

We use Eq. 9.8.14 to write the reciprocity relation

$$\left(\frac{\partial \mu_B}{\partial r} \right)_{T,p,n_A,n_B} = -\omega^2 r \left(\frac{\partial m}{\partial n_B} \right)_{T,p,n_A,r} \quad (9.8.15)$$

Then, using $m = n_A M_A + n_B M_B$, we obtain

$$\left(\frac{\partial \mu_B}{\partial r} \right)_{T,p,n_A,n_B} = -M_B \omega^2 r \quad (9.8.16)$$

Thus at constant T , p , and composition, which are the conditions that allow the activity $a_{c,B}$ to remain constant, μ_B for the sample varies with r according to $d\mu_B = -M_B \omega^2 r dr$. We integrate from radial position r' to position r'' to obtain

$$\begin{aligned} \mu_B(r'') - \mu_B(r') &= -M_B \omega^2 \int_{r'}^{r''} r dr \\ &= -\frac{1}{2} M_B \omega^2 \left[(r'')^2 - (r')^2 \right] \end{aligned} \quad (9.8.17)$$

$(a_{c,B}(r'') = a_{c,B}(r'))$

Let us take r' as a reference position, such as the end of the centrifuge cell farthest from the axis of rotation. We define the standard chemical potential $\mu_{c,B}^\circ$ as the solute chemical potential under standard state conditions on a concentration basis at this position. The solute chemical potential and activity at this position are related by

$$\mu_B(r') = \mu_{c,B}^\circ + RT \ln a_{c,B}(r') \quad (9.8.18)$$

From Eqs. 9.8.17 and 9.8.18, we obtain the following general relation between μ_B and $a_{c,B}$ at an arbitrary radial position r'' :

$$\mu_B(r'') = \mu_{c,B}^\circ + RT \ln a_{c,B}(r'') - \frac{1}{2} M_B \omega^2 \left[(r'')^2 - (r')^2 \right] \quad (9.8.19)$$

We found earlier that when the solution is in an equilibrium state, μ_B is independent of r —that is, $\mu_B(r'')$ is equal to $\mu_B(r')$ for any value of r'' . When we equate expressions given by Eq. 9.8.19 for $\mu_B(r'')$ and $\mu_B(r')$ and rearrange, we obtain the following relation between the activities at the two radial positions:

$$\ln \frac{a_{c,B}(r'')}{a_{c,B}(r')} = \frac{M_B \omega^2}{2RT} \left[(r'')^2 - (r')^2 \right] \quad (9.8.20)$$

(solution in centrifuge cell at equilibrium)

The solute activity is related to the concentration c_B by $a_{c,B} = \Gamma_{c,B} \gamma_{c,B} c_B/c^\circ$. We assume the solution is sufficiently dilute for the activity coefficient $\gamma_{c,B}$ to be approximated by 1. The pressure factor is given by $\Gamma_{c,B} \approx \exp[V_B^\infty(p - p^\circ)/RT]$ (Table 9.6). These relations give us another expression for the logarithm of the ratio of activities:

$$\ln \frac{a_{c,B}(r'')}{a_{c,B}(r')} = \frac{V_B^\infty(p'' - p')}{RT} + \ln \frac{c_B(r'')}{c_B(r')} \quad (9.8.21)$$

We substitute for $p'' - p'$ from Eq. 9.8.12. It is also useful to make the substitution $V_B^\infty = M_B v_B^\infty$, where v_B^∞ is the partial specific volume of the solute at infinite dilution (page 237).

When we equate the two expressions for $\ln[a_{c,B}(r'')/a_{c,B}(r')]$, we obtain finally

$$\ln \frac{c_B(r'')}{c_B(r')} = \frac{M_B(1 - v_B^\infty \rho) \omega^2}{2RT} [(r'')^2 - (r')^2] \quad (9.8.22)$$

(solution in centrifuge cell at equilibrium)

This equation shows that if the solution density ρ is less than the effective solute density $1/v_B^\infty$, so that $v_B^\infty \rho$ is less than 1, the solute concentration increases with increasing distance from the axis of rotation in the equilibrium state. If, however, ρ is greater than $1/v_B^\infty$, the concentration decreases with increasing r . The factor $(1 - v_B^\infty \rho)$ is like a buoyancy factor for the effect of the centrifugal field on the solute.

Equation 9.8.22 is needed for *sedimentation equilibrium*, a method of determining the molar mass of a macromolecule. A dilute solution of the macromolecule is placed in the cell of an analytical ultracentrifuge, and the angular velocity is selected to produce a measurable solute concentration gradient at equilibrium. The solute concentration is measured optically as a function of r . The equation predicts that a plot of $\ln(c_B/c^\circ)$ versus r^2 will be linear, with a slope equal to $M_B(1 - v_B^\infty \rho) \omega^2/2RT$. The partial specific volume v_B^∞ is found from measurements of solution density as a function of solute mass fraction (page 237). By this means, the molar mass M_B of the macromolecule is evaluated.

PROBLEMS

An underlined problem number or problem-part letter indicates that the numerical answer appears in Appendix I.

- 9.1** For a binary solution, find expressions for the mole fractions x_B and x_A as functions of the solute molality m_B .
- 9.2** Consider a binary mixture of two liquids, A and B. The molar volume of mixing, $\Delta V(\text{mix})/n$, is given by Eq. 9.2.19.
- (a) Find a formula for calculating the value of $\Delta V(\text{mix})/n$ of a binary mixture from values of x_A , x_B , M_A , M_B , ρ , ρ_A^* , and ρ_B^* .

Table 9.7 Molar volumes of mixing of binary mixtures of 1-hexanol (A) and 1-octene (B) at 25 °C.^a

x_B	$[\Delta V(\text{mix})/n]/\text{cm}^3 \text{ mol}^{-1}$	x_B	$[\Delta V(\text{mix})/n]/\text{cm}^3 \text{ mol}^{-1}$
0	0	0.555	0.005
0.049	-0.027	0.597	0.011
0.097	-0.050	0.702	0.029
0.146	-0.063	0.716	0.035
0.199	-0.077	0.751	0.048
0.235	-0.073	0.803	0.056
0.284	-0.074	0.846	0.058
0.343	-0.065	0.897	0.057
0.388	-0.053	0.944	0.049
0.448	-0.032	1	0
0.491	-0.016		

^aRef. [170].

- (b) The molar volumes of mixing for liquid binary mixtures of 1-hexanol (A) and 1-octene (B) at 25 °C have been calculated from their measured densities. The data are in Table 9.7. The molar volumes of the pure constituents are $V_A^* = 125.31 \text{ cm}^3 \text{ mol}^{-1}$ and $V_B^* = 157.85 \text{ cm}^3 \text{ mol}^{-1}$. Use the method of intercepts to estimate the partial molar volumes of both constituents in an equimolar mixture ($x_A = x_B = 0.5$), and the partial molar volume V_B^∞ of B at infinite dilution.
- 9.3** Extend the derivation of Prob. 8.1, concerning a liquid droplet of radius r suspended in a gas, to the case in which the liquid and gas are both mixtures. Show that the equilibrium conditions are $T^g = T^l$, $\mu_i^g = \mu_i^l$ (for each species i that can equilibrate between the two phases), and $p^l = p^g + 2\gamma/r$, where γ is the surface tension. (As in Prob. 8.1, the last relation is the Laplace equation.)
- 9.4** Consider a gaseous mixture of 4.0000×10^{-2} mol of N_2 (A) and 4.0000×10^{-2} mol of CO_2 (B) in a volume of $1.0000 \times 10^{-3} \text{ m}^3$ at a temperature of 298.15 K. The second virial coefficients at this temperature have the values¹⁴

$$\begin{aligned}
 B_{AA} &= -4.8 \times 10^{-6} \text{ m}^3 \text{ mol}^{-1} \\
 B_{BB} &= -124.5 \times 10^{-6} \text{ m}^3 \text{ mol}^{-1} \\
 B_{AB} &= -47.5 \times 10^{-6} \text{ m}^3 \text{ mol}^{-1}
 \end{aligned}$$

Compare the pressure of the real gas mixture with that predicted by the ideal gas equation. See Eqs. 9.3.20 and 9.3.23.

¹⁴Refs. [3], [49], and [50].

9.5 At 25 °C and 1 bar, the Henry's law constants of nitrogen and oxygen dissolved in water are $k_{\text{H,N}_2} = 8.64 \times 10^4$ bar and $k_{\text{H,O}_2} = 4.41 \times 10^4$ bar.¹⁵ The vapor pressure of water at this temperature and pressure is $p_{\text{H}_2\text{O}} = 0.032$ bar. Assume that dry air contains only N₂ and O₂ at mole fractions $y_{\text{N}_2} = 0.788$ and $y_{\text{O}_2} = 0.212$. Consider liquid–gas systems formed by equilibrating liquid water and air at 25 °C and 1.000 bar, and assume that the gas phase behaves as an ideal gas mixture.

Hint: The sum of the partial pressures of N₂ and O₂ must be $(1.000 - 0.032)$ bar = 0.968 bar. If the volume of one of the phases is much larger than that of the other, then almost all of the N₂ and O₂ will be in the predominant phase and the ratio of their amounts in this phase must be practically the same as in dry air.

Determine the mole fractions of N₂ and O₂ in both phases in the following limiting cases:

- (a) A large volume of air is equilibrated with just enough water to leave a small drop of liquid.
 (b) A large volume of water is equilibrated with just enough air to leave a small bubble of gas.

9.6 Derive the expression for $\gamma_{m,B}$ given in Table 9.4, starting with Eq. 9.5.18.

9.7 Consider a nonideal binary gas mixture with the simple equation of state $V = nRT/p + nB$ (Eq. 9.3.21).

- (a) The *rule of Lewis and Randall* states that the value of the mixed second virial coefficient B_{AB} is the average of B_{AA} and B_{BB} . Show that when this rule holds, the fugacity coefficient of A in a binary gas mixture of any composition is given by $\ln \phi_A = B_{AA}p/RT$. By comparing this expression with Eq. 7.8.18 for a pure gas, express the fugacity of A in the mixture as a function of the fugacity of pure A at the same temperature and pressure as the mixture.
 (b) The rule of Lewis and Randall is not accurately obeyed when constituents A and B are chemically dissimilar. For example, at 298.15 K, the second virial coefficients of H₂O (A) and N₂ (B) are $B_{AA} = -1158$ cm³ mol⁻¹ and $B_{BB} = -5$ cm³ mol⁻¹, respectively, whereas the mixed second virial coefficient is $B_{AB} = -40$ cm³ mol⁻¹.

When liquid water is equilibrated with nitrogen at 298.15 K and 1 bar, the partial pressure of H₂O in the gas phase is $p_A = 0.03185$ bar. Use the given values of B_{AA} , B_{BB} , and B_{AB} to calculate the fugacity of the gaseous H₂O in this binary mixture. Compare this fugacity with the fugacity calculated with the value of B_{AB} predicted by the rule of Lewis and Randall.

Table 9.8 Activity coefficient of benzene (A) in mixtures of benzene and 1-octanol at 20 °C. The reference state is the pure liquid.

x_A	γ_A	x_A	γ_A
0	2.0 ^a	0.7631	1.183
0.1334	1.915	0.8474	1.101
0.2381	1.809	0.9174	1.046
0.4131	1.594	0.9782	1.005
0.5805	1.370		

^aextrapolated

¹⁵Ref. [184].

9.8 Benzene and 1-octanol are two liquids that mix in all proportions. Benzene has a measurable vapor pressure, whereas 1-octanol is practically nonvolatile. The data in Table 9.8 on the preceding page were obtained by Platford¹⁶ using the isopiestic vapor pressure method.

- (a) Use numerical integration to evaluate the integral on the right side of Eq. 9.6.10 at each of the values of x_A listed in the table, and thus find γ_B at these compositions.
- (b) Draw two curves on the same graph showing the effective mole fractions $\gamma_A x_A$ and $\gamma_B x_B$ as functions of x_A . Are the deviations from ideal-mixture behavior positive or negative?

Table 9.9 Liquid and gas compositions in the two-phase system of methanol (A) and benzene (B) at 45 °C^a

x_A	y_A	p/kPa	x_A	y_A	p/kPa
0	0	29.894	0.4201	0.5590	60.015
0.0207	0.2794	40.962	0.5420	0.5783	60.416
0.0314	0.3391	44.231	0.6164	0.5908	60.416
0.0431	0.3794	46.832	0.7259	0.6216	59.868
0.0613	0.4306	50.488	0.8171	0.6681	58.321
0.0854	0.4642	53.224	0.9033	0.7525	54.692
0.1811	0.5171	57.454	0.9497	0.8368	51.009
0.3217	0.5450	59.402	1	1	44.608

^aRef. [169].

9.9 Table 9.9 lists measured values of gas-phase composition and total pressure for the binary two-phase methanol–benzene system at constant temperature and varied liquid-phase composition. x_A is the mole fraction of methanol in the liquid mixture, and y_A is the mole fraction of methanol in the equilibrated gas phase.

- (a) For each of the 16 different liquid-phase compositions, tabulate the partial pressures of A and B in the equilibrated gas phase.
- (b) Plot p_A and p_B versus x_A on the same graph. Notice that the behavior of the mixture is far from that of an ideal mixture. Are the deviations from Raoult's law positive or negative?
- (c) Tabulate and plot the activity coefficient γ_B of the benzene as a function of x_A using a pure-liquid reference state. Assume that the fugacity f_B is equal to p_B , and ignore the effects of variable pressure.
- (d) Estimate the Henry's law constant $k_{H,A}$ of methanol in the benzene environment at 45 °C by the graphical method suggested in Fig. 9.7(b). Again assume that f_A and p_A are equal, and ignore the effects of variable pressure.
- 9.10** Consider a dilute binary nonelectrolyte solution in which the dependence of the chemical potential of solute B on composition is given by

$$\mu_B = \mu_{m,B}^{\text{ref}} + RT \ln \frac{m_B}{m^\circ} + k_m m_B$$

where $\mu_{m,B}^{\text{ref}}$ and k_m are constants at a given T and p . (The derivation of this equation is sketched in Sec. 9.5.4.) Use the Gibbs–Duhem equation in the form $d\mu_A = -(n_B/n_A) d\mu_B$ to obtain an expression for $\mu_A - \mu_A^*$ as a function of m_B in this solution.

¹⁶Ref. [145].

9.11 By means of the isopiestic vapor pressure technique, the osmotic coefficients of aqueous solutions of urea at 25 °C have been measured at molalities up to the saturation limit of about 20 mol kg⁻¹.¹⁷ The experimental values are closely approximated by the function

$$\phi_m = 1.00 - \frac{0.050 m_B/m^\circ}{1.00 + 0.179 m_B/m^\circ}$$

where m° is 1 mol kg⁻¹. Calculate values of the solvent and solute activity coefficients γ_A and $\gamma_{m,B}$ at various molalities in the range 0–20 mol kg⁻¹, and plot them versus m_B/m° . Use enough points to be able to see the shapes of the curves. What are the limiting slopes of these curves as m_B approaches zero?

9.12 Use Eq. 9.2.49 to derive an expression for the rate at which the logarithm of the activity coefficient of component i of a liquid mixture changes with pressure at constant temperature and composition: $(\partial \ln \gamma_i / \partial p)_{T, \{n_i\}} = ?$

9.13 Assume that at sea level the atmosphere has a pressure of 1.00 bar and a composition given by $y_{N_2} = 0.788$ and $y_{O_2} = 0.212$. Find the partial pressures and mole fractions of N₂ and O₂, and the total pressure, at an altitude of 10.0 km, making the (drastic) approximation that the atmosphere is an ideal gas mixture in an equilibrium state at 0 °C. For g use the value of the standard acceleration of free fall listed in Appendix B.

9.14 Consider a tall column of a dilute binary liquid solution at equilibrium in a gravitational field.

- Derive an expression for $\ln [c_B(h)/c_B(0)]$, where $c_B(h)$ and $c_B(0)$ are the solute concentrations at elevations h and 0. Your expression should be a function of h , M_B , T , ρ , and the partial specific volume of the solute at infinite dilution, v_B^∞ . For the dependence of pressure on elevation, you may use the hydrostatic formula $dp = -\rho g dh$ (Eq. 8.1.14 on page 200) and assume the solution density ρ is the same at all elevations. Hint: use the derivation leading to Eq. 9.8.22 as a guide.
- Suppose you have a tall vessel containing a dilute solution of a macromolecule solute of molar mass $M_B = 10.0 \text{ kg mol}^{-1}$ and partial specific volume $v_B^\infty = 0.78 \text{ cm}^3 \text{ g}^{-1}$. The solution density is $\rho = 1.00 \text{ g cm}^{-3}$ and the temperature is $T = 300 \text{ K}$. Find the height h from the bottom of the vessel at which, in the equilibrium state, the concentration c_B has decreased to 99 percent of the concentration at the bottom.

9.15 FhuA is a protein found in the outer membrane of the *Escherichia coli* bacterium. From the known amino acid sequence, its molar mass is calculated to be 78,804 kg mol⁻¹. In aqueous solution, molecules of the detergent dodecyl maltoside bind to a FhuA molecule to form an aggregate that behaves as a single solute species. Figure 9.13 on the next page shows data collected in a sedimentation equilibrium experiment with a dilute solution of the aggregate.¹⁸ In the graph, A is the absorbance measured at a wavelength of 280 nm (a property that is a linear function of the aggregate concentration) and r is the radial distance from the axis of rotation of the centrifuge rotor. The experimental points fall very close to the straight line shown in the graph. The sedimentation conditions were $\omega = 838 \text{ s}^{-1}$ and $T = 293 \text{ K}$. The authors used the values $v_B^\infty = 0.776 \text{ cm}^3 \text{ g}^{-1}$ and $\rho = 1.004 \text{ g cm}^{-3}$.

- The values of r at which the absorbance was measured range from 6.95 cm to 7.20 cm. Find the difference of pressure in the solution between these two positions.
- Find the molar mass of the aggregate solute species, and use it to estimate the mass binding ratio (the mass of bound detergent divided by the mass of protein).

¹⁷Ref. [160]. ¹⁸Ref. [18].

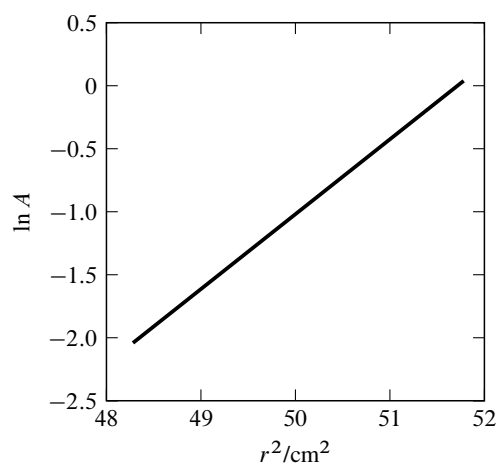

Figure 9.13 Sedimentation equilibrium of a dilute solution of the FhuA-dodecyl maltoside aggregate.

ELECTROLYTE SOLUTIONS

The thermodynamic properties of electrolyte solutions differ in significant ways from the properties of mixtures of nonelectrolytes.

Here is an example. Pure HCl (hydrogen chloride) is a gas that is very soluble in water. A plot of the partial pressure of gaseous HCl in equilibrium with aqueous HCl, as a function of the solution molality (Fig. 10.1), shows that the limiting slope at infinite dilution is not finite, but zero. What is the reason for this non-Henry's law behavior? It must be because HCl is an electrolyte—it dissociates (ionizes) in the aqueous environment.

It is customary to use a *molality* basis for the reference and standard states of electrolyte solutes. This is the only basis used in this chapter, even when not explicitly indicated for ions. The symbol μ_+° , for instance, denotes the chemical potential of a cation in a standard state based on molality.

In dealing with an electrolyte solute, we can refer to the solute (a substance) as a whole and to the individual charged ions that result from dissociation. We can apply the same general definitions of chemical potential, activity coefficient, and activity to these different species, but only the activity coefficient and activity of the solute as a whole can be evaluated

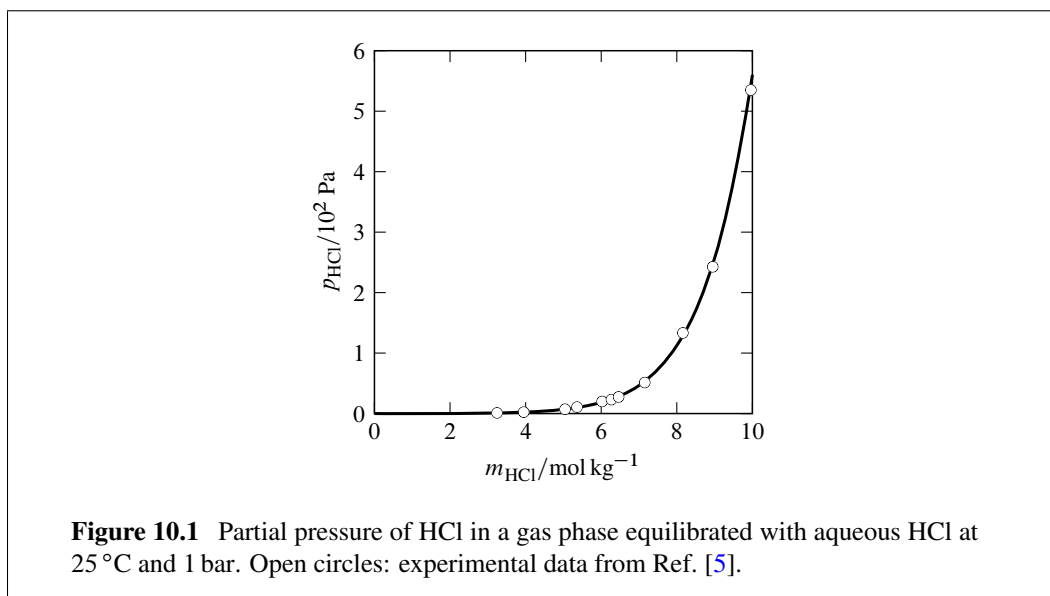

experimentally.

10.1 Single-ion Quantities

Consider a solution of an electrolyte solute that dissociates completely into a cation species and an anion species. Subscripts $+$ and $-$ will be used to denote the cation and anion, respectively. The solute molality m_B is defined as the amount of solute formula unit divided by the mass of solvent.

We first need to investigate the relation between the chemical potential of an ion species and the electric potential of the solution phase.

The electric potential ϕ in the interior of a phase is called the *inner electric potential*, or *Galvani potential*. It is defined as the work needed to reversibly move an infinitesimal test charge into the phase from a position infinitely far from other charges, divided by the value of the test charge. The electrical potential energy of a charge in the phase is the product of ϕ and the charge.

Consider a hypothetical process in which an infinitesimal amount dn_+ of the cation is transferred into a solution phase at constant T and p . The quantity of charge transferred is $\delta Q = z_+ F dn_+$, where z_+ is the charge number ($+1$, $+2$, etc.) of the cation, and F is the Faraday constant.¹ If the phase is at zero electric potential, the process causes no change in its electrical potential energy. However, if the phase has a finite electric potential ϕ , the transfer process changes its electrical potential energy by $\phi \delta Q = z_+ F \phi dn_+$. Consequently, the internal energy change depends on ϕ according to

$$dU(\phi) = dU(0) + z_+ F \phi dn_+ \quad (10.1.1)$$

where the electric potential is indicated in parentheses. The change in the Gibbs energy of the phase is given by $dG = d(U - TS + pV)$, where T , S , p , and V are unaffected by the value of ϕ . The dependence of dG on ϕ is therefore

$$dG(\phi) = dG(0) + z_+ F \phi dn_+ \quad (10.1.2)$$

The Gibbs fundamental equation for an open system, $dG = -S dT + V dp + \sum_i \mu_i dn_i$ (Eq. 9.2.34), assumes the electric potential is zero. From this equation and Eq. 10.1.2, the Gibbs energy change during the transfer process at constant T and p is found to depend on ϕ according to

$$dG(\phi) = [\mu_+(0) + z_+ F \phi] dn_+ \quad (10.1.3)$$

The chemical potential of the cation in a phase of electric potential ϕ , defined by the partial molar Gibbs energy $[\partial G(\phi)/\partial n_+]_{T,p}$, is therefore given by

$$\mu_+(\phi) = \mu_+(0) + z_+ F \phi \quad (10.1.4)$$

The corresponding relation for an anion is

$$\mu_-(\phi) = \mu_-(0) + z_- F \phi \quad (10.1.5)$$

where z_- is the charge number of the anion (-1 , -2 , etc.). For a charged species in general, we have

$$\mu_i(\phi) = \mu_i(0) + z_i F \phi \quad (10.1.6)$$

¹The Faraday constant (page 452) is the charge per amount of protons.

We define the *standard state of an ion* on a molality basis in the same way as for a nonelectrolyte solute, with the additional stipulation that the ion is in a phase of zero electric potential. Thus, the standard state is a hypothetical state in which the ion is at molality m° with behavior extrapolated from infinite dilution on a molality basis, in a phase of pressure $p = p^\circ$ and electric potential $\phi = 0$.

The *standard chemical potential* μ_+° or μ_-° of a cation or anion is the chemical potential of the ion in its standard state. Single-ion activities a_+ and a_- in a phase of zero electric potential are defined by relations having the form of Eq. 9.7.8:

$$\mu_+(0) = \mu_+^\circ + RT \ln a_+ \quad \mu_-(0) = \mu_-^\circ + RT \ln a_- \quad (10.1.7)$$

As explained on page 271, a_+ and a_- should depend on the temperature, pressure, and composition of the phase, and not on the value of ϕ .

From Eqs. 10.1.4, 10.1.5, and 10.1.7, the relations between the chemical potential of a cation or anion, its activity, and the electric potential of its phase, are found to be

$$\mu_+ = \mu_+^\circ + RT \ln a_+ + z_+ F\phi \quad \mu_- = \mu_-^\circ + RT \ln a_- + z_- F\phi \quad (10.1.8)$$

These relations are definitions of single-ion activities in a phase of electric potential ϕ .

For a charged species in general, we can write²

$$\mu_i = \mu_i^\circ + RT \ln a_i + z_i F\phi \quad (10.1.9)$$

Note that we can also apply this equation to an uncharged species, because the charge number z_i is then zero and Eq. 10.1.9 becomes the same as Eq. 9.7.2 on page 271.

Of course there is no experimental way to evaluate either μ_+ or μ_- relative to a reference state or standard state, because it is impossible to add cations or anions by themselves to a solution. We can nevertheless write some theoretical relations involving μ_+ and μ_- .

For a given temperature and pressure, we can write the dependence of the chemical potentials of the ions on their molalities in the same form as that given by Eq. 9.5.18 for a nonelectrolyte solute:

$$\mu_+ = \mu_+^{\text{ref}} + RT \ln \left(\gamma_+ \frac{m_+}{m^\circ} \right) \quad \mu_- = \mu_-^{\text{ref}} + RT \ln \left(\gamma_- \frac{m_-}{m^\circ} \right) \quad (10.1.10)$$

Here μ_+^{ref} and μ_-^{ref} are the chemical potentials of the cation and anion in solute reference states. Each reference state is defined as a hypothetical solution with the same temperature, pressure, and electric potential as the solution under consideration; in this solution, the molality of the ion has the standard value m° , and the ion behaves according to Henry's law based on molality. γ_+ and γ_- are single-ion activity coefficients on a molality basis.

The single-ion activity coefficients approach unity in the limit of infinite dilution:

$$\gamma_+ \rightarrow 1 \quad \text{and} \quad \gamma_- \rightarrow 1 \quad \text{as} \quad m_B \rightarrow 0 \quad (10.1.11)$$

(constant T , p , and ϕ)

In other words, we assume that in an extremely dilute electrolyte solution each individual ion behaves like a nonelectrolyte solute species in an ideal-dilute solution. At a finite solute

²Some thermodynamicists call the quantity $(\mu_i^\circ + RT \ln a_i)$, which depends only on T , p , and composition, the *chemical potential* of ion i , and the quantity $(\mu_i^\circ + RT \ln a_i + z_i F\phi)$ the *electrochemical potential* with symbol $\tilde{\mu}_i$.

molality, the values of γ_+ and γ_- are the ones that allow Eq. 10.1.10 to give the correct values of the quantities $(\mu_+ - \mu_+^{\text{ref}})$ and $(\mu_- - \mu_-^{\text{ref}})$. We have no way to actually measure these quantities experimentally, so we cannot evaluate either γ_+ or γ_- .

We can define single-ion pressure factors Γ_+ and Γ_- as follows:

$$\Gamma_+ \stackrel{\text{def}}{=} \exp\left(\frac{\mu_+^{\text{ref}} - \mu_+^\circ}{RT}\right) \approx \exp\left[\frac{V_+^\infty(p - p^\circ)}{RT}\right] \quad (10.1.12)$$

$$\Gamma_- \stackrel{\text{def}}{=} \exp\left(\frac{\mu_-^{\text{ref}} - \mu_-^\circ}{RT}\right) \approx \exp\left[\frac{V_-^\infty(p - p^\circ)}{RT}\right] \quad (10.1.13)$$

The approximations in these equations are like those in Table 9.6 for nonelectrolyte solutes; they are based on the assumption that the partial molar volumes V_+ and V_- are independent of pressure.

From Eqs. 10.1.7, 10.1.10, 10.1.12, and 10.1.13, the single-ion activities are related to the solution composition by

$$a_+ = \Gamma_+ \gamma_+ \frac{m_+}{m^\circ} \quad a_- = \Gamma_- \gamma_- \frac{m_-}{m^\circ} \quad (10.1.14)$$

Then, from Eq. 10.1.9, we have the following relations between the chemical potentials and molalities of the ions:

$$\mu_+ = \mu_+^\circ + RT \ln(\Gamma_+ \gamma_+ m_+ / m^\circ) + z_+ F\phi \quad (10.1.15)$$

$$\mu_- = \mu_-^\circ + RT \ln(\Gamma_- \gamma_- m_- / m^\circ) + z_- F\phi \quad (10.1.16)$$

Like the values of γ_+ and γ_- , values of the single-ion quantities a_+ , a_- , Γ_+ , and Γ_- cannot be determined by experiment.

10.2 Solution of a Symmetrical Electrolyte

Let us consider properties of an electrolyte solute as a whole. The simplest case is that of a binary solution in which the solute is a symmetrical strong electrolyte—a substance whose formula unit has one cation and one anion that dissociate completely. This condition will be indicated by $\nu = 2$, where ν is the number of ions per formula unit. In an aqueous solution, the solute with ν equal to 2 might be a 1:1 salt such as NaCl, a 2:2 salt such as MgSO_4 , or a strong monoprotic acid such as HCl.

In this binary solution, the chemical potential of the solute as a whole is defined in the usual way as the partial molar Gibbs energy

$$\mu_B \stackrel{\text{def}}{=} \left(\frac{\partial G}{\partial n_B}\right)_{T,p,n_A} \quad (10.2.1)$$

and is a function of T , p , and the solute molality m_B . Although μ_B under given conditions must in principle have a definite value, we are not able to actually evaluate it because we have no way to measure precisely the energy brought into the system by the solute. This energy contributes to the internal energy and thus to G . We can, however, evaluate the differences $\mu_B - \mu_{m,B}^{\text{ref}}$ and $\mu_B - \mu_{m,B}^\circ$.

We can write the additivity rule (Eq. 9.2.25) for G as either

$$G = n_A \mu_A + n_B \mu_B \quad (10.2.2)$$

or

$$G = n_A \mu_A + n_+ \mu_+ + n_- \mu_- \quad (10.2.3)$$

A comparison of these equations for a symmetrical electrolyte ($n_B = n_+ = n_-$) gives us the relation

$$\mu_B = \mu_+ + \mu_- \quad (10.2.4)$$

($v=2$)

We see that the solute chemical potential in this case is the *sum* of the single-ion chemical potentials.

The solution is a phase of electric potential ϕ . From Eqs. 10.1.4 and 10.1.5, the sum $\mu_+ + \mu_-$ appearing in Eq. 10.2.4 is

$$\mu_+(\phi) + \mu_-(\phi) = \mu_+(0) + \mu_-(0) + (z_+ + z_-)F\phi \quad (10.2.5)$$

For the symmetrical electrolyte, the sum ($z_+ + z_-$) is zero, so that μ_B is equal to $\mu_+(0) + \mu_-(0)$. We substitute the expressions of Eq. 10.1.10, use the relation $\mu_{m,B}^{\text{ref}} = \mu_+^{\text{ref}} + \mu_-^{\text{ref}}$ with reference states at $\phi=0$, set the ion molalities m_+ and m_- equal to m_B , and obtain

$$\mu_B = \mu_{m,B}^{\text{ref}} + RT \ln \left[\gamma_+ \gamma_- \left(\frac{m_B}{m^\circ} \right)^2 \right] \quad (10.2.6)$$

($v=2$)

The important feature of this relation is the appearance of the *second* power of m_B/m° , instead of the first power as in the case of a nonelectrolyte. Also note that μ_B does not depend on ϕ , unlike μ_+ and μ_- .

Although we cannot evaluate γ_+ or γ_- individually, we can evaluate the product $\gamma_+ \gamma_-$. This product is the square of the **mean ionic activity coefficient** γ_\pm , defined for a symmetrical electrolyte by

$$\gamma_\pm \stackrel{\text{def}}{=} \sqrt{\gamma_+ \gamma_-} \quad (10.2.7)$$

($v=2$)

With this definition, Eq. 10.2.6 becomes

$$\mu_B = \mu_{m,B}^{\text{ref}} + RT \ln \left[(\gamma_\pm)^2 \left(\frac{m_B}{m^\circ} \right)^2 \right] \quad (10.2.8)$$

($v=2$)

Since it is possible to determine the value of $\mu_B - \mu_{m,B}^{\text{ref}}$ for a solution of known molality, γ_\pm is a measurable quantity.

If the electrolyte (e.g., HCl) is sufficiently volatile, its mean ionic activity coefficient in a solution can be evaluated from partial pressure measurements of an equilibrated gas phase. Section 10.6 will describe a general method by which γ_\pm can be found from osmotic coefficients. Section 14.5 describes how, in favorable cases, it is possible to evaluate γ_\pm from the equilibrium cell potential of a galvanic cell.

The activity $a_{m,B}$ of a solute substance on a molality basis is defined by Eq. 9.7.8 on page 273:

$$\mu_B = \mu_{m,B}^\circ + RT \ln a_{m,B} \quad (10.2.9)$$

Here $\mu_{m,B}^\circ$ is the chemical potential of the solute in its standard state, which is the solute reference state at the standard pressure. By equating the expressions for μ_B given by Eqs. 10.2.8 and 10.2.9 and solving for the activity, we obtain

$$a_{m,B} = \Gamma_{m,B} (\gamma_{\pm})^2 \left(\frac{m_B}{m^\circ}\right)^2 \quad (10.2.10)$$

($v=2$)

where $\Gamma_{m,B}$ is the pressure factor defined by

$$\Gamma_{m,B} \stackrel{\text{def}}{=} \exp\left(\frac{\mu_{m,B}^{\text{ref}} - \mu_{m,B}^\circ}{RT}\right) \quad (10.2.11)$$

We can use the appropriate expression in Table 9.6 on page 276 to evaluate $\Gamma_{m,B}$ at an arbitrary pressure p' :

$$\Gamma_{m,B}(p') = \exp\left(\int_{p^\circ}^{p'} \frac{V_B^\infty}{RT} dp\right) \approx \exp\left[\frac{V_B^\infty(p' - p^\circ)}{RT}\right] \quad (10.2.12)$$

The value of $\Gamma_{m,B}$ is 1 at the standard pressure, and close to 1 at any reasonably low pressure (page 275). For this reason it is common to see Eq. 10.2.10 written as $a_{m,B} = \gamma_{\pm}^2 (m_B/m^\circ)^2$, with $\Gamma_{m,B}$ omitted.

Equation 10.2.10 predicts that the activity of HCl in aqueous solutions is proportional, in the limit of infinite dilution, to the *square* of the HCl molality. In contrast, the activity of a nonelectrolyte solute is proportional to the *first* power of the molality in this limit. This predicted behavior of aqueous HCl is consistent with the data plotted in Fig. 10.1 on page 287, and is confirmed by the data for dilute HCl solutions shown in Fig. 10.2(a). The dashed line in Fig. 10.2(a) is the extrapolation of the ideal-dilute behavior given by $a_{m,B} = (m_B/m^\circ)^2$. The extension of this line to $m_B = m^\circ$ establishes the hypothetical solute reference state based on molality, indicated by a filled circle in Fig. 10.2(b). (Since the data are for solutions at the standard pressure of 1 bar, the solute reference state shown in the figure is also the solute standard state.)

The solid curve of Fig. 10.2(c) shows how the mean ionic activity coefficient of HCl varies with molality in approximately the same range of molalities as the data shown in Fig. 10.2(b). In the limit of infinite dilution, γ_{\pm} approaches unity. The slope of the curve approaches $-\infty$ in this limit, quite unlike the behavior described in Sec. 9.5.4 for the activity coefficient of a nonelectrolyte solute.

For a symmetrical strong electrolyte, γ_{\pm} is the geometric average of the single-ion activity coefficients γ_+ and γ_- . We have no way of evaluating γ_+ or γ_- individually, even if we know the value of γ_{\pm} . For instance, we cannot assume that γ_+ and γ_- are equal.

10.3 Electrolytes in General

The formula unit of a nonsymmetrical electrolyte solute has more than two ions. General formulas for the solute as a whole are more complicated than those for the symmetrical case treated in the preceding section, but are derived by the same reasoning.

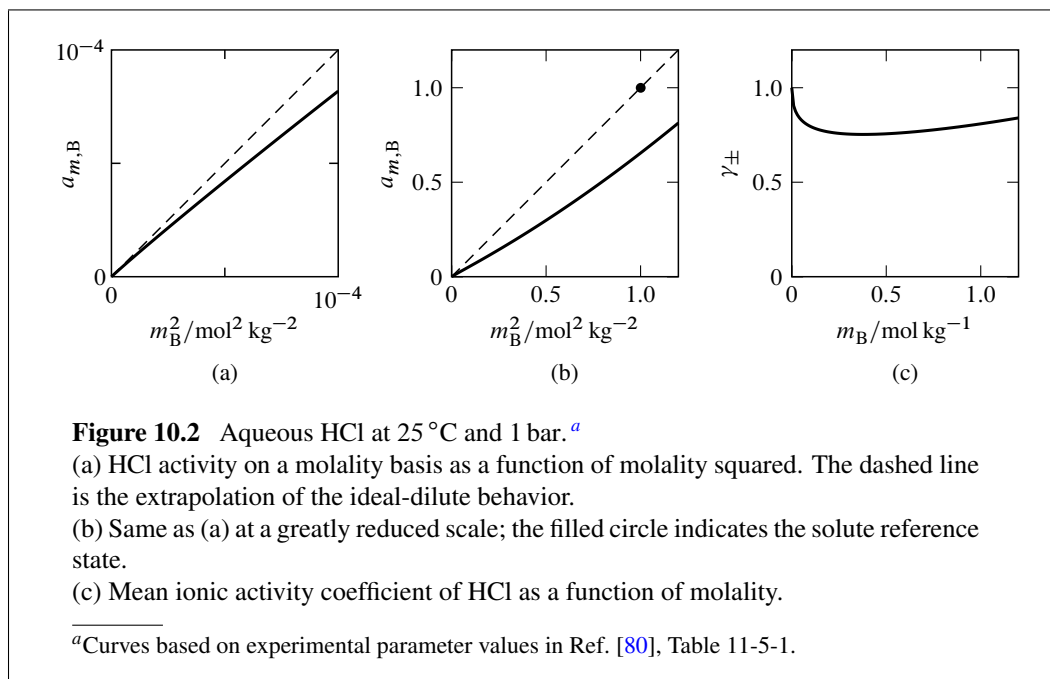

Again we assume the solute dissociates completely into its constituent ions. We define the following symbols:

ν_+ = the number of cations per solute formula unit

ν_- = the number of anions per solute formula unit

ν = the sum $\nu_+ + \nu_-$

For example, if the solute formula is $\text{Al}_2(\text{SO}_4)_3$, the values are $\nu_+=2$, $\nu_-=3$, and $\nu=5$.

10.3.1 Solution of a single electrolyte

In a solution of a single electrolyte solute that is not necessarily symmetrical, the ion molalities are related to the overall solute molality by

$$m_+ = \nu_+ m_B \quad m_- = \nu_- m_B \quad (10.3.1)$$

From the additivity rule for the Gibbs energy, we have

$$\begin{aligned} G &= n_A \mu_A + n_B \mu_B \\ &= n_A \mu_A + \nu_+ n_B \mu_+ + \nu_- n_B \mu_- \end{aligned} \quad (10.3.2)$$

giving the relation

$$\mu_B = \nu_+ \mu_+ + \nu_- \mu_- \quad (10.3.3)$$

in place of Eq. 10.2.4. The cations and anions are in the same phase of electric potential ϕ . We use Eqs. 10.1.4 and 10.1.5 to obtain

$$\begin{aligned} \nu_+ \mu_+(\phi) + \nu_- \mu_-(\phi) \\ = \nu_+ \mu_+(0) + \nu_- \mu_-(0) + (\nu_+ z_+ + \nu_- z_-) F \phi \end{aligned} \quad (10.3.4)$$

Electrical neutrality requires that $(\nu_+ z_+ + \nu_- z_-)$ be zero, giving

$$\mu_B = \nu_+ \mu_+(0) + \nu_- \mu_-(0) \quad (10.3.5)$$

By combining Eq. 10.3.5 with Eqs. 10.1.10, 10.3.1, and 10.3.3, we obtain

$$\mu_B = \mu_B^{\text{ref}} + RT \ln \left[(\nu_+^{\nu_+} \nu_-^{\nu_-}) (\gamma_+^{\nu_+}) (\gamma_-^{\nu_-}) \left(\frac{m_B}{m^\circ} \right)^\nu \right] \quad (10.3.6)$$

where $\mu_B^{\text{ref}} = \nu_+ \mu_+^{\text{ref}} + \nu_- \mu_-^{\text{ref}}$ is the chemical potential of the solute in the hypothetical reference state at $\phi=0$ in which B is at the standard molality and behaves as at infinite dilution. Equation 10.3.6 is the generalization of Eq. 10.2.6. It shows that although μ_+ and μ_- depend on ϕ , μ_B does not.

The mean ionic activity coefficient γ_\pm is defined in general by

$$\gamma_\pm^\nu = (\gamma_+^{\nu_+}) (\gamma_-^{\nu_-}) \quad (10.3.7)$$

or

$$\gamma_\pm = (\gamma_+^{\nu_+} \gamma_-^{\nu_-})^{1/\nu} \quad (10.3.8)$$

Thus γ_\pm is a geometric average of γ_+ and γ_- weighted by the numbers of the cations and anions in the solute formula unit. With a substitution from Eq. 10.3.7, Eq. 10.3.6 becomes

$$\mu_B = \mu_B^{\text{ref}} + RT \ln \left[(\nu_+^{\nu_+} \nu_-^{\nu_-}) \gamma_\pm^\nu \left(\frac{m_B}{m^\circ} \right)^\nu \right] \quad (10.3.9)$$

Since $\mu_B - \mu_B^{\text{ref}}$ is a measurable quantity, so also is γ_\pm .

The solute activity, defined by $\mu_B = \mu_{m,B}^\circ + RT \ln a_{m,B}$, is

$$a_{m,B} = (\nu_+^{\nu_+} \nu_-^{\nu_-}) \Gamma_{m,B} \gamma_\pm^\nu \left(\frac{m_B}{m^\circ} \right)^\nu \quad (10.3.10)$$

where $\Gamma_{m,B}$ is the pressure factor that we can evaluate with Eq. 10.2.12. Equation 10.3.10 is the generalization of Eq. 10.2.10. From Eqs. 10.1.12, 10.1.13, and 10.2.11 and the relations $\mu_B^{\text{ref}} = \nu_+ \mu_+^{\text{ref}} + \nu_- \mu_-^{\text{ref}}$ and $\mu_{m,B}^\circ = \nu_+ \mu_+^\circ + \nu_- \mu_-^\circ$, we obtain the relation

$$\Gamma_{m,B} = \Gamma_+^{\nu_+} \Gamma_-^{\nu_-} \quad (10.3.11)$$

10.3.2 Multisolute solution

Equation 10.3.3 relates the chemical potential of electrolyte B in a binary solution to the single-ion chemical potentials of its constituent ions:

$$\mu_B = \nu_+ \mu_+ + \nu_- \mu_- \quad (10.3.12)$$

This relation is valid for each individual solute substance in a multisolute solution, even when two or more of the electrolyte solutes have an ion species in common.

As an illustration of this principle, consider a solution prepared by dissolving amounts n_B of BaI_2 and n_C of CsI in an amount n_A of H_2O . Assume the dissolved salts are completely dissociated into ions, with the I^- ion common to both. The additivity rule for the Gibbs energy of this solution can be written in the form

$$G = n_A \mu_A + n_B \mu_B + n_C \mu_C \quad (10.3.13)$$

and also, using single-ion quantities, in the form

$$G = n_A \mu_A + n_B \mu(\text{Ba}^{2+}) + 2n_B \mu(\text{I}^-) + n_C \mu(\text{Cs}^+) + n_C \mu(\text{I}^-) \quad (10.3.14)$$

Comparing Eqs. 10.3.13 and 10.3.14, we find the following relations must exist between the chemical potentials of the solute substances and the ion species:

$$\mu_B = \mu(\text{Ba}^{2+}) + 2\mu(\text{I}^-) \quad \mu_C = \mu(\text{Cs}^+) + \mu(\text{I}^-) \quad (10.3.15)$$

These relations agree with Eq. 10.3.12. Note that $\mu(\text{I}^-)$, the chemical potential of the ion common to both salts, appears in both relations.

The solute activity $a_{m,B}$ is defined by the relation $\mu_B = \mu_B^\circ + RT \ln a_{m,B}$ (Eq. 10.2.9). Using this relation together with Eqs. 10.1.7 and 10.1.14, we find that the solute activity is related to ion molalities by

$$a_{m,B} = \Gamma_{m,B} \gamma_{\pm}^{\nu} \left(\frac{m_+}{m^\circ} \right)^{\nu_+} \left(\frac{m_-}{m^\circ} \right)^{\nu_-} \quad (10.3.16)$$

where the pressure factor $\Gamma_{m,B}$ is defined in Eq. 10.2.11. The ion molalities in this expression refer to the constituent ions of solute B, which in a multisolute solution are not necessarily present in the same stoichiometric ratio as in the solute substance.

For instance, suppose we apply Eq. 10.3.16 to the solution of BaI_2 and CsI used above as an illustration of a multisolute solution, letting $a_{m,B}$ be the activity of solute substance BaI_2 . The quantities m_+ and m_- in the equation are then the molalities of the Ba^{2+} and I^- ions, and γ_{\pm} is the mean ionic activity coefficient of the dissolved BaI_2 . Note that in this solution the Ba^{2+} and I^- ions are not present in the 1:2 ratio found in BaI_2 , because I^- is a constituent of both solutes.

10.3.3 Incomplete dissociation

In the preceding sections of this chapter, the electrolyte solute or solutes have been assumed to be completely dissociated into their constituent ions at all molalities. Some solutions, however, contain *ion pairs*—closely associated ions of opposite charge. Furthermore, in solutions of some electrolytes (often called “weak” electrolytes), an equilibrium is established between ions and electrically-neutral molecules. In these kinds of solutions, the relations between solute molality and ion molalities given by Eq. 10.3.1 are no longer valid. When dissociation is not complete, the expression for μ_B given by Eq. 10.3.9 can still be used. However, the quantity γ_{\pm} appearing in the expression no longer has the physical significance of being the geometric average of the activity coefficients of the actual dissociated ions, and is called the **stoichiometric activity coefficient** of the electrolyte.

10.4 The Debye–Hückel Theory

The theory of Peter Debye and Erich Hückel (1923) provides theoretical expressions for single-ion activity coefficients and mean ionic activity coefficients in electrolyte solutions. The expressions in one form or another are very useful for extrapolation of quantities that include mean ionic activity coefficients to low solute molality or infinite dilution.

The only interactions the theory considers are the electrostatic interactions between ions. These interactions are much stronger than those between uncharged molecules, and

BIOGRAPHICAL SKETCH

Peter Josephus Wilhelmus Debye (1884–1966)



Peter Debye made major contributions to various areas of chemistry and physics.

He was born in Maastricht, The Netherlands, where his father was foreman in a machine workshop.

Henri Sack, a close associate for 40 years, recalled in 1968:^a

He was not only endowed with a most powerful and penetrating intellect and an unmatched ability for presenting his ideas in a most lucid way, but he also knew the art of living a full life. He greatly enjoyed his scientific endeavors, he had a deep love for his family and home life, and he had an eye for the beauties of nature and a taste for the pleasure of the out-of-doors as manifested by his hobbies such as fishing, collecting cacti, and gardening, mostly in the company of Mrs. Debye.

Before World War II, Debye held appointments at several universities in The Netherlands, Switzerland, and Germany. He emigrated to America in 1940 and was at Cornell University in Ithaca, New York until his death. He became an American citizen in 1946.

Debye was responsible for theoretical treatments of a variety of subjects, including molecular dipole moments (for which the *debye* is a non-SI unit), X-ray diffraction and scattering, and light scattering. His theories relevant to thermodynamics include the temperature dependence of the heat capacity of crystals at a low temperature (Debye crystal theory), adiabatic demagnetization, and the Debye–Hückel theory of electrolyte solutions.

In an interview in 1962, Debye said that he

actually had not been interested in electrolytes at all. He had been at a colloquium at which a new theory of electrolytes had been described that was supposed to explain why the conductivity of a dilute solution of a strong electrolyte is proportional to the square root of the concentration. Debye, on hearing this description, objected that the theory neglected the effects of Brownian motion. The discussion became heated, and some of those present told Debye “you will have to do something about it.” What Debye did about it was to ask his assistant, Erich Hückel, to study the literature and find out what they were missing. That, according to Debye in the interview, is how the Debye–Hückel theory came about.^b

In a reminiscence of Debye published in 1972, Erich Hückel wrote:^c

My personal relations with Debye were always completely care-free. Although I was 12 years younger than he and a complete freshman when I came to Zürich, he always treated me as his equal.

...Debye conceived his work—in my opinion—as an artist who operates on the basis of joy in his work and its creations, and who was led often by intuition, which was then later on rationally founded in the most plain and clear way leaving out everything that was unessential. ... I never found in Debye any interest in philosophical questions. Debye’s way of life seemed to me rather straightforward and uncomplicated. He liked a good dinner: when a problem could not be solved after a physics lecture, he used to say: “one must enjoy a good evening dinner and then the inspiration comes by itself”...Debye received an immense number of awards. It did not seem to matter much to him. When I visited him in Berlin to congratulate him on the Nobel Prize, he interrupted: “Fine that you are here.” My congratulations were therefore not completed.

Debye was awarded the 1936 Nobel Prize in Chemistry “for his contributions to our knowledge of molecular structure through his investigations on dipole moments and on the diffraction of X-rays and electrons in gases.”

^aRef. [62], page 232. ^bRef. [44]. ^cTranslation in Ref. [173], pages 73–74.

they die off more slowly with distance. If the positions of ions in an electrolyte solution were completely random, the net effect of electrostatic ion–ion interactions would be zero, because each cation–cation or anion–anion repulsion would be balanced by a cation–anion attraction. The positions are not random, however: each cation has a surplus of anions in its immediate environment, and each anion has a surplus of neighboring cations. Each ion therefore has a net attractive interaction with the surrounding ion atmosphere. The result for a cation species at low electrolyte molality is a decrease of μ_+ compared to the cation at same molality in the absence of ion–ion interactions, meaning that the single-ion activity coefficient γ_+ becomes less than 1 as the electrolyte molality is increased beyond the ideal-dilute range. Similarly, γ_- also becomes less than 1.

According to the Debye–Hückel theory, the single-ion activity coefficient γ_i of ion i in a solution of one or more electrolytes is given by

$$\ln \gamma_i = -\frac{A_{\text{DH}} z_i^2 \sqrt{I_m}}{1 + B_{\text{DH}} a \sqrt{I_m}} \quad (10.4.1)$$

where

z_i = the charge number of ion i (+1, -2, etc.);

I_m = the **ionic strength** of the solution on a molality basis, defined by³

$$I_m \stackrel{\text{def}}{=} \frac{1}{2} \sum_{\text{all ions}} m_j z_j^2 \quad (10.4.2)$$

A_{DH} and B_{DH} are defined functions of the kind of solvent and the temperature;

a is an adjustable parameter, equal to the mean effective distance of closest approach of other ions in the solution to one of the i ions.

The definitions of the quantities A_{DH} and B_{DH} appearing in Eq. 10.4.1 are

$$A_{\text{DH}} \stackrel{\text{def}}{=} (N_{\text{A}}^2 e^3 / 8\pi) (2\rho_{\text{A}}^*)^{1/2} (\epsilon_r \epsilon_0 RT)^{-3/2} \quad (10.4.3)$$

$$B_{\text{DH}} \stackrel{\text{def}}{=} N_{\text{A}} e (2\rho_{\text{A}}^*)^{1/2} (\epsilon_r \epsilon_0 RT)^{-1/2} \quad (10.4.4)$$

where N_{A} is the Avogadro constant, e is the elementary charge (the charge of a proton), ρ_{A}^* and ϵ_r are the density and relative permittivity (dielectric constant) of the solvent, and ϵ_0 is the electric constant (or permittivity of vacuum).

When the solvent is water at 25 °C, the quantities A_{DH} and B_{DH} have the values

$$A_{\text{DH}} = 1.1744 \text{ kg}^{1/2} \text{ mol}^{-1/2} \quad (10.4.5)$$

$$B_{\text{DH}} = 3.285 \times 10^9 \text{ m}^{-1} \text{ kg}^{1/2} \text{ mol}^{-1/2} \quad (10.4.6)$$

From Eqs. 10.3.8 and 10.4.1 and the electroneutrality condition $\nu_+ z_+ = \nu_- z_-$, we obtain the following expression for the logarithm of the mean ionic activity coefficient of an electrolyte solute:

$$\ln \gamma_{\pm} = -\frac{A_{\text{DH}} |z_+ z_-| \sqrt{I_m}}{1 + B_{\text{DH}} a \sqrt{I_m}} \quad (10.4.7)$$

³ Lewis and Randall (Ref. [108]) introduced the term *ionic strength*, defined by this equation, two years before the Debye–Hückel theory was published. They found empirically that in dilute solutions, the mean ionic activity coefficient of a given strong electrolyte is the same in all solutions having the same ionic strength.

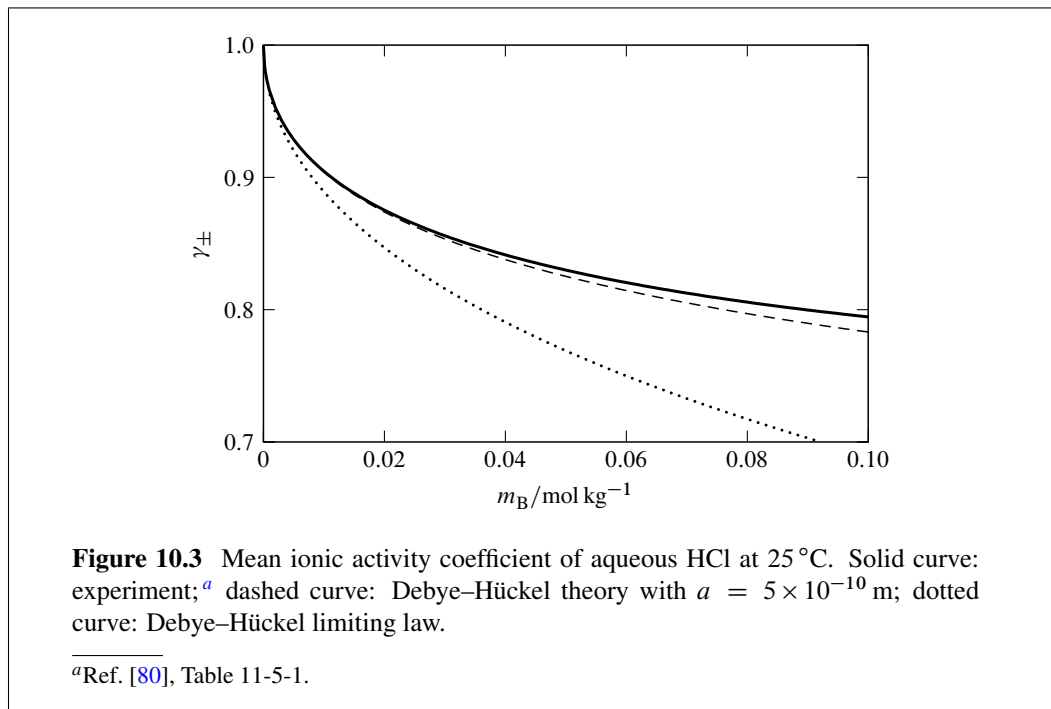

In this equation, z_+ and z_- are the charge numbers of the cation and anion of the solute. Since the right side of Eq. 10.4.7 is negative at finite solute molalities, and zero at infinite dilution, the theory predicts that γ_{\pm} is less than 1 at finite solute molalities and approaches 1 at infinite dilution.

Figure 10.3 shows that with the proper choice of the parameter a , the mean ionic activity coefficient of HCl calculated from Eq. 10.4.7 (dashed curve) agrees closely with experiment (solid curve) at low molalities.

As the molalities of all solutes become small, Eq. 10.4.7 becomes

$$\ln \gamma_{\pm} = -A_{\text{DH}} |z_+ z_-| \sqrt{I_m} \quad (10.4.8)$$

(infinite dilution)

This form is known as the **Debye–Hückel limiting law**. Note that the limiting law contains no adjustable parameters. The dotted curve in Fig. 10.3 shows that the limiting law agrees with experiment only at quite low molality.

The ionic strength I_m is calculated from Eq. 10.4.2 with the molalities of *all* ions in the solution, not just the molality of the ion or solute whose activity coefficient we are interested in. This is because, as explained above, the departure of γ_+ and γ_- from the ideal-dilute value of 1 is caused by the interaction of each ion with the ion atmosphere resulting from all other ions in the solution.

In a binary solution of a single electrolyte solute, assumed to be completely dissociated, the relation between the ionic strength and the solute molality depends on ν (the number of ions per solute formula unit) and the charge numbers z_+ and z_- . The ionic strength is given by $I_m = (1/2) \sum_i m_i z_i^2 = (1/2)(\nu_+ z_+^2 + \nu_- z_-^2) m_B$. With the help of the electroneutrality

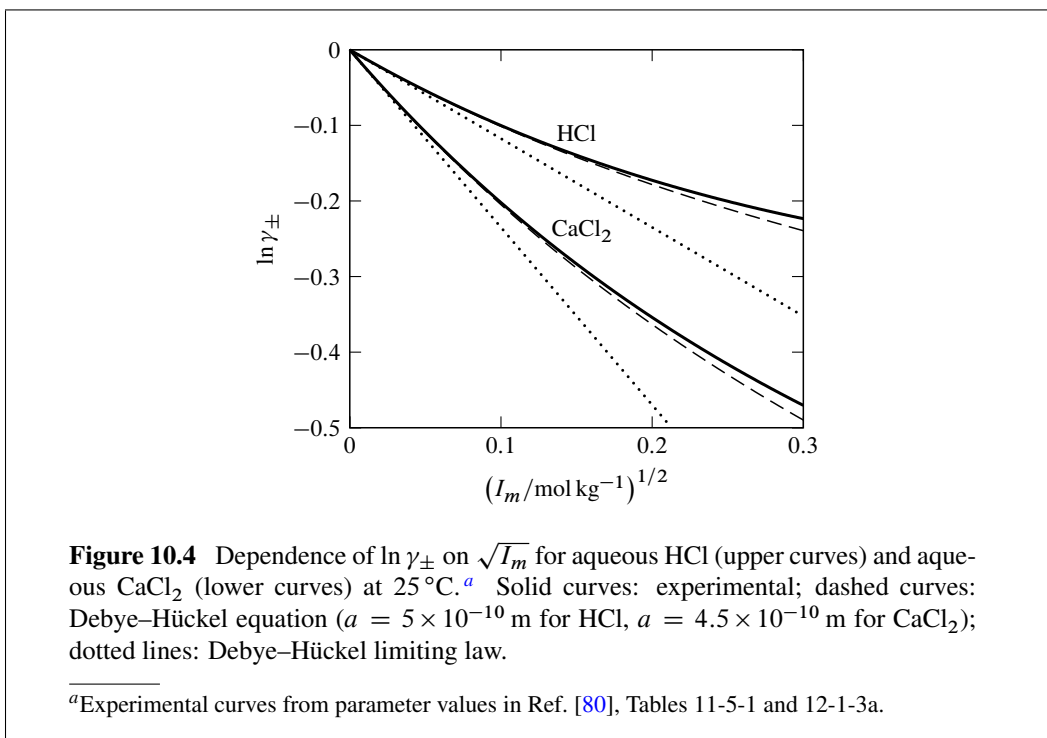

condition $\nu_+ z_+ = -(\nu_- z_-)$, this becomes

$$\begin{aligned} I_m &= \frac{1}{2} [-(\nu_- z_-)z_+ - (\nu_+ z_+)z_-] m_B \\ &= \frac{1}{2} [-(\nu_- + \nu_+)z_+ z_-] m_B \\ &= \frac{1}{2} \nu |z_+ z_-| m_B \end{aligned} \quad (10.4.9)$$

We find the following relations hold between I_m and m_B in the binary solution, depending on the stoichiometry of the solute formula unit:

For a 1:1 electrolyte, e.g., NaCl or HCl: $I_m = m_B$

For a 1:2 or 2:1 electrolyte, e.g., Na_2SO_4 or CaCl_2 : $I_m = 3m_B$

For a 2:2 electrolyte, e.g., MgSO_4 : $I_m = 4m_B$

For a 1:3 or 3:1 electrolyte, e.g., AlCl_3 : $I_m = 6m_B$

For a 3:2 or 2:3 electrolyte, e.g., $\text{Al}_2(\text{SO}_4)_3$: $I_m = 15m_B$

Figure 10.4 shows $\ln \gamma_{\pm}$ as a function of $\sqrt{I_m}$ for aqueous HCl and CaCl_2 . The experimental curves have the limiting slopes predicted by the Debye–Hückel limiting law (Eq. 10.4.8), but at a low ionic strength the curves begin to deviate significantly from the linear relations predicted by that law. The full Debye–Hückel equation (Eq. 10.4.7) fits the experimental curves over a wider range of ionic strength.

10.5 Derivation of the Debye–Hückel Equation

Debye and Hückel derived Eq. 10.4.1 using a combination of electrostatic theory, statistical mechanical theory, and thermodynamics. This section gives a brief outline of their derivation.

The derivation starts by focusing on an individual ion of species i as it moves through the solution; call it the central ion. Around this central ion, the time-average spatial distribution of any ion species j is not random, on account of the interaction of these ions of species j with the central ion. (Species i and j may be the same or different.) The distribution, whatever it is, must be spherically symmetric about the central ion; that is, a function only of the distance r from the center of the ion. The local concentration, c'_j , of the ions of species j at a given value of r depends on the ion charge $z_j e$ and the electric potential ϕ at that position. The time-average electric potential in turn depends on the distribution of all ions and is symmetric about the central ion, so expressions must be found for c'_j and ϕ as functions of r that are mutually consistent.

Debye and Hückel assumed that c'_j is given by the Boltzmann distribution

$$c'_j = c_j e^{-z_j e \phi / kT} \quad (10.5.1)$$

where $z_j e \phi$ is the electrostatic energy of an ion of species j , and k is the Boltzmann constant ($k = R/N_A$). As r becomes large, ϕ approaches zero and c'_j approaches the macroscopic concentration c_j . As T increases, c'_j at a fixed value of r approaches c_j because of the randomizing effect of thermal energy. Debye and Hückel expanded the exponential function in powers of $1/T$ and retained only the first two terms: $c'_j \approx c_j (1 - z_j e \phi / kT)$. The distribution of each ion species is assumed to follow this relation. The electric potential function consistent with this distribution and with the electroneutrality of the solution as a whole is

$$\phi = (z_i e / 4\pi\epsilon_r\epsilon_0 r) e^{\kappa(a-r)} / (1 + \kappa a) \quad (10.5.2)$$

Here κ is defined by $\kappa^2 = 2N_A^2 e^2 I_c / \epsilon_r \epsilon_0 RT$, where I_c is the *ionic strength on a concentration basis* defined by $I_c = (1/2) \sum_i c_i z_i^2$.

The electric potential ϕ at a point is assumed to be a sum of two contributions: the electric potential the central ion would cause at infinite dilution, $z_i e / 4\pi\epsilon_r\epsilon_0 r$, and the electric potential due to all other ions, ϕ' . Thus, ϕ' is equal to $\phi - z_i e / 4\pi\epsilon_r\epsilon_0 r$, or

$$\phi' = (z_i e / 4\pi\epsilon_r\epsilon_0 r) [e^{\kappa(a-r)} / (1 + \kappa a) - 1] \quad (10.5.3)$$

This expression for ϕ' is valid for distances from the center of the central ion down to a , the distance of closest approach of other ions. At smaller values of r , ϕ' is constant and equal to the value at $r = a$, which is $\phi'(a) = -(z_i e / 4\pi\epsilon_r\epsilon_0) \kappa / (1 + \kappa a)$. The interaction energy between the central ion and the surrounding ions (the ion atmosphere) is the product of the central ion charge and $\phi'(a)$.

The last step of the derivation is the calculation of the work of a hypothetical reversible process in which the surrounding ions stay in their final distribution, and the charge of the central ion gradually increases from zero to its actual value $z_i e$. Let $\alpha z_i e$ be the charge at each stage of the process, where α is a fractional advancement that changes from 0 to 1. Then the work w' due to the interaction of the central ion with its ion atmosphere is $\phi'(a)$ integrated over the charge:

$$\begin{aligned} w' &= - \int_{\alpha=0}^{\alpha=1} [(\alpha z_i e / 4\pi\epsilon_r\epsilon_0) \kappa / (1 + \kappa a)] d(\alpha z_i e) \\ &= -(z_i^2 e^2 / 8\pi\epsilon_r\epsilon_0) \kappa / (1 + \kappa a) \end{aligned} \quad (10.5.4)$$

Since the infinitesimal Gibbs energy change in a reversible process is given by $dG = -S dT + V dp + \delta w'$ (Eq. 5.8.6), this reversible nonexpansion work at constant T and p is equal to the Gibbs energy change. The Gibbs energy change per amount of species i is $w'N_A = -(z_i^2 e^2 N_A / 8\pi \epsilon_r \epsilon_0) \kappa / (1 + \kappa a)$. This quantity is $\Delta G/n_i$ for the process in which a solution of fixed composition changes from a hypothetical state lacking ion–ion interactions to the real state with ion–ion interactions present. $\Delta G/n_i$ may be equated to the difference of the chemical potentials of i in the final and initial states. If the chemical potential without ion–ion interactions is taken to be that for ideal-dilute behavior on a molality basis, $\mu_i = \mu_{m,i}^{\text{ref}} + RT \ln(m_i/m^\circ)$, then $-(z_i^2 e^2 N_A / 8\pi \epsilon_r \epsilon_0) \kappa / (1 + \kappa a)$ is equal to $\mu_i - [\mu_{m,i}^{\text{ref}} + RT \ln(m_i/m^\circ)] = RT \ln \gamma_{m,i}$. In a dilute solution, c_i can with little error be set equal to $\rho_A^* m_i$, and I_c to $\rho_A^* I_m$. Equation 10.4.1 follows.

10.6 Mean Ionic Activity Coefficients from Osmotic Coefficients

Recall that γ_{\pm} is the mean ionic activity coefficient of a strong electrolyte, or the stoichiometric activity coefficient of an electrolyte that does not dissociate completely.

The general procedure described in this section for evaluating γ_{\pm} requires knowledge of the osmotic coefficient ϕ_m as a function of molality. ϕ_m is commonly evaluated by the isopiestic method (Sec. 9.6.4) or from measurements of freezing-point depression (Sec. 12.2).

The osmotic coefficient of a binary solution of an electrolyte is defined by

$$\phi_m \stackrel{\text{def}}{=} \frac{\mu_A^* - \mu_A}{RTM_A \nu m_B} \quad (10.6.1)$$

(binary electrolyte solution)

That is, for an electrolyte the sum $\sum_{i \neq A} m_i$ appearing in the definition of ϕ_m for a nonelectrolyte solution (Eq. 9.6.11 on page 268) is replaced by νm_B , the sum of the ion molalities assuming complete dissociation. It will now be shown that ϕ_m defined this way can be used to evaluate γ_{\pm} .

The derivation is like that described in Sec. 9.6.3 for a binary solution of a nonelectrolyte. Solving Eq. 10.6.1 for μ_A and taking the differential of μ_A at constant T and p , we obtain

$$d\mu_A = -RTM_A \nu (\phi_m dm_B + m_B d\phi_m) \quad (10.6.2)$$

From Eq. 10.3.9 on page 294, we obtain

$$d\mu_B = RT \nu \left(d \ln \gamma_{\pm} + \frac{dm_B}{m_B} \right) \quad (10.6.3)$$

Substitution of these expressions in the Gibbs–Duhem equation $n_A d\mu_A + n_B d\mu_B = 0$, together with the substitution $n_A M_A = n_B / m_B$, yields

$$d \ln \gamma_{\pm} = d\phi_m + \frac{\phi_m - 1}{m_B} dm_B \quad (10.6.4)$$

Then integration from $m_B = 0$ to any desired molality m'_B gives the result

$$\ln \gamma_{\pm}(m'_B) = \phi_m(m'_B) - 1 + \int_0^{m'_B} \frac{\phi_m - 1}{m_B} dm_B \quad (10.6.5)$$

The right side of this equation is the same expression as derived for $\ln \gamma_{m,B}$ for a nonelectrolyte (Eq. 9.6.20 on page 269).

The integrand of the integral on the right side of Eq. 10.6.5 approaches $-\infty$ as m_B approaches zero, making it difficult to evaluate the integral by numerical integration starting at $m_B = 0$. (This difficulty does not exist when the solute is a nonelectrolyte.) Instead, we can split the integral into two parts

$$\int_0^{m'_B} \frac{\phi_m - 1}{m_B} dm_B = \int_0^{m''_B} \frac{\phi_m - 1}{m_B} dm_B + \int_{m''_B}^{m'_B} \frac{\phi_m - 1}{m_B} dm_B \quad (10.6.6)$$

where the integration limit m''_B is a low molality at which the value of ϕ_m is available and at which γ_{\pm} can either be measured or estimated from the Debye–Hückel equation.

We next rewrite Eq. 10.6.5 with m'_B replaced with m''_B :

$$\ln \gamma_{\pm}(m''_B) = \phi_m(m''_B) - 1 + \int_0^{m''_B} \frac{\phi_m - 1}{m_B} dm_B \quad (10.6.7)$$

By eliminating the integral with an upper limit of m''_B from Eqs. 10.6.6 and 10.6.7, we obtain

$$\int_0^{m'_B} \frac{\phi_m - 1}{m_B} dm_B = \ln \gamma_{\pm}(m''_B) - \phi_m(m''_B) + 1 + \int_{m''_B}^{m'_B} \frac{\phi_m - 1}{m_B} dm_B \quad (10.6.8)$$

Equation 10.6.5 becomes

$$\ln \gamma_{\pm}(m'_B) = \phi_m(m'_B) - \phi_m(m''_B) + \ln \gamma_{\pm}(m''_B) + \int_{m''_B}^{m'_B} \frac{\phi_m - 1}{m_B} dm_B \quad (10.6.9)$$

The integral on the right side of this equation can easily be evaluated by numerical integration.

PROBLEMS

An underlined problem number or problem-part letter indicates that the numerical answer appears in Appendix I.

10.1 The mean ionic activity coefficient of NaCl in a 0.100 molal aqueous solution at 298.15 K has been evaluated with measurements of equilibrium cell potentials,⁴ with the result $\ln \gamma_{\pm} = -0.2505$. Use this value in Eq. 10.6.9, together with the values of osmotic coefficients in Table 10.1, to evaluate γ_{\pm} at each of the molalities shown in the table; then plot γ_{\pm} as a function of m_B .

Table 10.1 Osmotic coefficients of aqueous NaCl at 298.15 K^a

$m_B/\text{mol kg}^{-1}$	ϕ_m	$m_B/\text{mol kg}^{-1}$	ϕ_m
0.1	0.9325	2.0	0.9866
0.2	0.9239	3.0	1.0485
0.3	0.9212	4.0	1.1177
0.5	0.9222	5.0	1.1916
1.0	0.9373	6.0	1.2688
1.5	0.9598		

^aRef. [31].

10.2 Rard and Miller⁵ used published measurements of the freezing points of dilute aqueous solutions of Na₂SO₄ to calculate the osmotic coefficients of these solutions at 298.15 K. Use their values listed in Table 10.2 to evaluate the mean ionic activity coefficient of Na₂SO₄ at 298.15 K and a molality of $m_B = 0.15 \text{ mol kg}^{-1}$. For the parameter a in the Debye–Hückel equation (Eq. 10.4.7), use the value $a = 3.0 \times 10^{-10} \text{ m}$.

Table 10.2 Osmotic coefficients of aqueous Na₂SO₄ at 298.15 K

$m_B/\text{mol kg}^{-1}$	ϕ_m	$m_B/\text{mol kg}^{-1}$	ϕ_m
0.0126	0.8893	0.0637	0.8111
0.0181	0.8716	0.0730	0.8036
0.0228	0.8607	0.0905	0.7927
0.0272	0.8529	0.0996	0.7887
0.0374	0.8356	0.1188	0.7780
0.0435	0.8294	0.1237	0.7760
0.0542	0.8178	0.1605	0.7616
0.0594	0.8141		

⁴Ref. [154], Table 9.3. ⁵Ref. [151].

CHAPTER 11

REACTIONS AND OTHER CHEMICAL PROCESSES

This chapter discusses the thermodynamics of mixing processes and processes described by reaction equations (chemical equations). It introduces the important concepts of molar mixing and reaction quantities, advancement, and the thermodynamic equilibrium constant. The focus is on chemical processes that take place in closed systems at constant pressure, with no work other than expansion work. Under these conditions, the enthalpy change is equal to the heat (Eq. 5.3.7). The processes either take place at constant temperature, or have initial and final states of the same temperature.

Most of the processes to be described involve mixtures and have intermediate states that are nonequilibrium states. At constant temperature and pressure, these processes proceed spontaneously with decreasing Gibbs energy (Sec. 5.8).¹ When the rates of change are slow enough for thermal and mechanical equilibrium to be maintained, the spontaneity is due to lack of transfer equilibrium or reaction equilibrium. An equilibrium phase transition of a pure substance, however, is a special case: it is a reversible process of constant Gibbs energy (Sec. 8.3).

11.1 Mixing Processes

A **mixing process** is a process in which a mixture is formed from pure substances. In the initial state the system has two or more separate phases, each containing a different pure substance at the same temperature and pressure. The final state is a single-phase mixture at this temperature and pressure.

The process is illustrated schematically in Fig. 11.1 on the next page. When the partition is withdrawn, the two pure liquids mix spontaneously at constant pressure to form a single homogeneous phase. If necessary, heat transfer is used to return the phase to the initial temperature.

¹Processes in which G decreases are sometimes called *exergonic*.

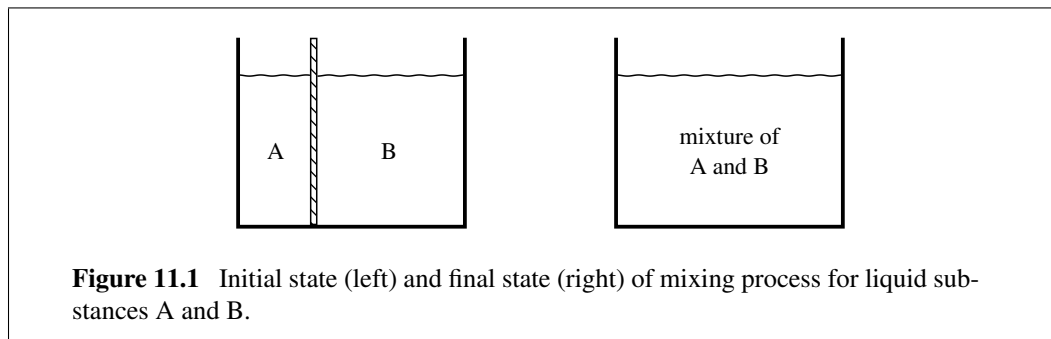

11.1.1 Mixtures in general

First let us consider changes in the Gibbs energy G . Since this is an extensive property, G in the initial state 1 is the sum of G for each pure phase:

$$G_1 = \sum_i n_i \mu_i^* \quad (11.1.1)$$

Here μ_i^* is the chemical potential (i.e., the molar Gibbs energy) of pure substance i at the initial temperature and pressure. For the final state 2, we use the additivity rule for a mixture

$$G_2 = \sum_i n_i \mu_i \quad (11.1.2)$$

where μ_i is the chemical potential of i in the mixture at the same temperature and pressure as the initial state. The overall change of G , the **Gibbs energy of mixing**, is then

$$\Delta G(\text{mix}) = G_2 - G_1 = \sum_i n_i (\mu_i - \mu_i^*) \quad (11.1.3)$$

The **molar Gibbs energy of mixing** is the Gibbs energy of mixing per amount of mixture formed; that is, $\Delta G_m(\text{mix}) = \Delta G(\text{mix})/n$, where n is the sum $\sum_i n_i$. Dividing both sides of Eq. 11.1.3 by n , we obtain

$$\Delta G_m(\text{mix}) = \sum_i x_i (\mu_i - \mu_i^*) \quad (11.1.4)$$

where x_i is the mole fraction of substance i in the final mixture.

Following the same procedure for an extensive state function X , we derive the following general relation for its molar mixing quantity:

$$\Delta X_m(\text{mix}) = \sum_i x_i (X_i - X_i^*) \quad (11.1.5)$$

11.1.2 Ideal mixtures

When the mixture formed is an ideal mixture (gas, liquid, or solid), and the pure constituents have the same physical state as the mixture, the expressions for various molar mixing quantities are particularly simple. An ideal molar mixing quantity will be indicated

by a superscript “id” as in $\Delta G_m^{\text{id}}(\text{mix})$. The general definition of an ideal molar mixing quantity, analogous to Eq. 11.1.5, is

$$\Delta X_m^{\text{id}}(\text{mix}) = \sum_i x_i (X_i^{\text{id}} - X_i^*) \quad (11.1.6)$$

The chemical potential of constituent i of an ideal mixture is related to the mole fraction x_i by the relation (Eq. 9.4.8)

$$\mu_i = \mu_i^* + RT \ln x_i \quad (11.1.7)$$

By combining this relation with Eq. 11.1.4, we find the molar Gibbs energy of mixing to form an ideal mixture is given by

$$\Delta G_m^{\text{id}}(\text{mix}) = RT \sum_i x_i \ln x_i \quad (11.1.8)$$

Since each mole fraction is less than one and the logarithm of a fraction is negative, it follows that $\Delta G_m^{\text{id}}(\text{mix})$ is negative for every composition of the mixture.

We obtain expressions for other molar mixing quantities by substituting formulas for partial molar quantities of constituents of an ideal mixture derived in Sec. 9.4.3 into Eq. 11.1.5. From $S_i = S_i^* - R \ln x_i$ (Eq. 9.4.9), we obtain

$$\Delta S_m^{\text{id}}(\text{mix}) = -R \sum_i x_i \ln x_i \quad (11.1.9)$$

This quantity is positive.

Although the molar entropy of mixing to form an *ideal* mixture is positive, this is not true for some nonideal mixtures. McGlashan² cites the *negative* value $\Delta S_m(\text{mix}) = -8.8 \text{ J K}^{-1} \text{ mol}^{-1}$ for an equimolar mixture of diethylamine and water at 322 K.

From $H_i = H_i^*$ (Eq. 9.4.10) and $U_i = U_i^*$ (Eq. 9.4.12), we have

$$\Delta H_m^{\text{id}}(\text{mix}) = 0 \quad (11.1.10)$$

and

$$\Delta U_m^{\text{id}}(\text{mix}) = 0 \quad (11.1.11)$$

Thus, the mixing of liquids that form an ideal mixture is an *athermal* process, one in which no heat transfer is needed to keep the temperature constant.

From $V_i = V_i^*$ (Eq. 9.4.11), we get

$$\Delta V_m^{\text{id}}(\text{mix}) = 0 \quad (11.1.12)$$

showing that the ideal molar volume of mixing is zero. Thus an ideal mixture has the same volume as the sum of the volumes of the pure components at the same T and p .³

Figure 11.2 on the next page shows how $\Delta G_m^{\text{id}}(\text{mix})$, $T\Delta S_m^{\text{id}}(\text{mix})$, and $\Delta H_m^{\text{id}}(\text{mix})$ depend on the composition of an ideal mixture formed by mixing two pure substances. Although it is not obvious in the figure, the curves for $\Delta G_m^{\text{id}}(\text{mix})$ and $T\Delta S_m^{\text{id}}(\text{mix})$ have slopes of $+\infty$ or $-\infty$ at $x_A=0$ and $x_A=1$.

²Ref. [120], p. 241.

³From the fact mentioned on p. 229 that the volume of a mixture of water and methanol is different from the sum of the volumes of the pure liquids, we can deduce that this mixture is nonideal, despite the fact that water and methanol mix in all proportions.

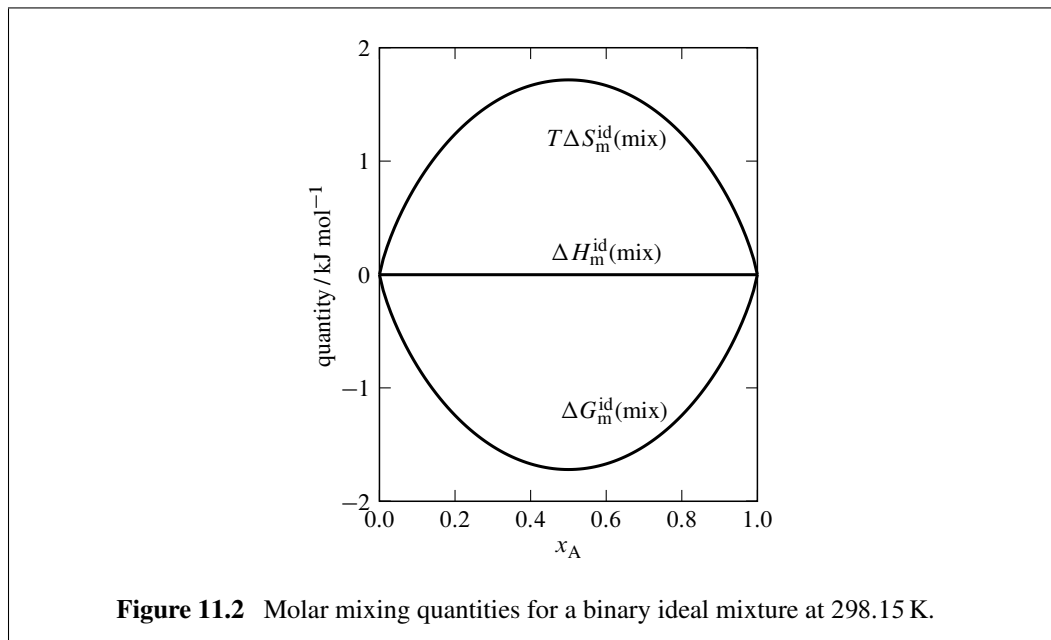

Figure 11.2 Molar mixing quantities for a binary ideal mixture at 298.15 K.

11.1.3 Excess quantities

An **excess quantity** X^E of a mixture is defined as the difference between the value of the extensive property X of the real mixture and X^{id} , the value for a hypothetical ideal mixture at the same temperature, pressure, and composition.

An **excess molar quantity** X_m^E is the excess quantity divided by n , the total amount of all constituents of the mixture. Examining the dependence of excess molar quantities on composition is a convenient way to characterize deviations from ideal-mixture behavior.

Excess molar quantities are related to molar mixing quantities as follows:

$$\begin{aligned}
 X_m^E &= (X - X^{\text{id}})/n = \left(\sum_i n_i X_i - \sum_i n_i X_i^{\text{id}} \right) / n \\
 &= \sum_i x_i (X_i - X_i^{\text{id}}) \\
 &= \sum_i x_i (X_i - X_i^*) - \sum_i x_i (X_i^{\text{id}} - X_i^*) \\
 &= \Delta X_m(\text{mix}) - \Delta X_m^{\text{id}}(\text{mix})
 \end{aligned} \tag{11.1.13}$$

By substituting expressions for $\Delta X_m^{\text{id}}(\text{mix})$ from Eqs. 11.1.8–11.1.12 in Eq. 11.1.13, we obtain the following expressions for the excess molar Gibbs energy, entropy, enthalpy, internal energy, and volume:

$$G_m^E = \Delta G_m(\text{mix}) - RT \sum_i x_i \ln x_i \tag{11.1.14}$$

$$S_m^E = \Delta S_m(\text{mix}) + R \sum_i x_i \ln x_i \tag{11.1.15}$$

$$H_m^E = \Delta H_m(\text{mix}) \tag{11.1.16}$$

$$U_m^E = \Delta U_m(\text{mix}) \quad (11.1.17)$$

$$V_m^E = \Delta V_m(\text{mix}) \quad (11.1.18)$$

By substitution from Eqs. 9.5.14 and 11.1.4 in Eq. 11.1.14, we can relate the excess molar Gibbs energy to the activity coefficients of the mixture constituents based on pure-liquid reference states:

$$G_m^E = RT \sum_i x_i \ln \gamma_i \quad (11.1.19)$$

It is also possible to derive the useful relation

$$\left[\frac{\partial (nG_m^E)}{\partial n_i} \right]_{T,p,n_{j \neq i}} = RT \ln \gamma_i \quad (11.1.20)$$

To derive Eq. 11.1.20, consider infinitesimal changes in the mixture composition at constant T and p . From Eq. 11.1.19, we write

$$d(nG_m^E) = RT \sum_i d(n_i \ln \gamma_i) = RT \sum_i n_i d \ln \gamma_i + RT \sum_i (\ln \gamma_i) dn_i \quad (11.1.21)$$

From $\mu_i = \mu_i^* + RT \ln(\gamma_i x_i)$, we have $d\mu_i = RT(d \ln \gamma_i + dx_i/x_i)$. Substitution in the Gibbs–Duhem equation, $\sum_i x_i d\mu_i = 0$, gives

$$\sum_i x_i d \ln \gamma_i + \sum_i dx_i = 0 \quad (11.1.22)$$

In Eq. 11.1.22, we set the sum $\sum_i dx_i$ equal to zero (because $\sum_i x_i$ equals 1) and multiply by the total amount, n , resulting in $\sum_i n_i d \ln \gamma_i = 0$. This turns Eq. 11.1.21 into

$$d(nG_m^E) = RT \sum_i (\ln \gamma_i) dn_i \quad (11.1.23)$$

from which Eq. 11.1.20 follows.

11.1.4 The entropy change to form an ideal gas mixture

When pure ideal gases mix at constant T and p to form an ideal gas mixture, the molar entropy change $\Delta S_m^{\text{id}}(\text{mix}) = -R \sum_i y_i \ln y_i$ (Eq. 11.1.9) is positive.

Consider a pure ideal-gas phase. Entropy is an extensive property, so if we divide this phase into two subsystems with an internal partition, the total entropy remains unchanged. The reverse process, the removal of the partition, must also have zero entropy change. Despite the fact that the latter process allows the molecules in the two subsystems to intermingle without a change in T or p , it cannot be considered “mixing” because the entropy does not increase. The essential point is that the *same* substance is present in both of the subsystems, so there is no macroscopic change of state when the partition is removed.

From these considerations, one might conclude that the fundamental reason the entropy increases when pure ideal gases mix is that different substances become intermingled. This conclusion would be mistaken, as we will now see.

The partial molar entropy of constituent i of an ideal gas mixture is related to its partial pressure p_i by Eq. 9.3.6:

$$S_i = S_i^\circ - R \ln(p_i/p^\circ) \quad (11.1.24)$$

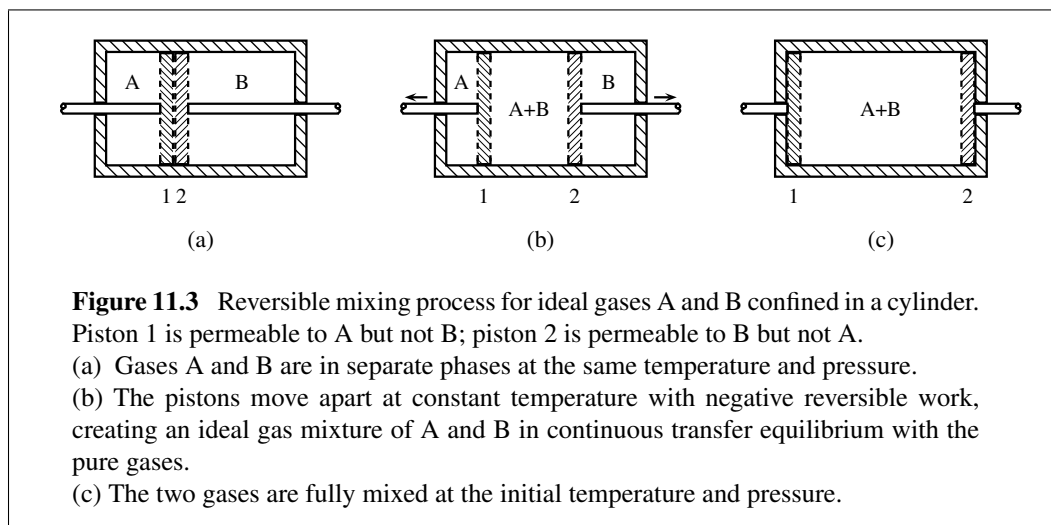

Figure 11.3 Reversible mixing process for ideal gases A and B confined in a cylinder. Piston 1 is permeable to A but not B; piston 2 is permeable to B but not A. (a) Gases A and B are in separate phases at the same temperature and pressure. (b) The pistons move apart at constant temperature with negative reversible work, creating an ideal gas mixture of A and B in continuous transfer equilibrium with the pure gases. (c) The two gases are fully mixed at the initial temperature and pressure.

But p_i is equal to $n_i RT/V$ (Eq. 9.3.3). Therefore, if a fixed amount of i is in a container at a given temperature, S_i depends only on the *volume* of the container and is unaffected by the presence of the other constituents of the ideal gas mixture.

When Eq. 11.1.24 is applied to a *pure* ideal gas, it gives an expression for the molar entropy

$$S_i^* = S_i^\circ - R \ln(p/p^\circ) \quad (11.1.25)$$

where p is equal to nRT/V .

From Eqs. 11.1.24 and 11.1.25, and the fact that the entropy of a mixture is given by the additivity rule $S = \sum_i n_i S_i$, we conclude that *the entropy of an ideal gas mixture equals the sum of the entropies of the unmixed pure ideal gases, each pure gas having the same temperature and occupying the same volume as in the mixture.*

We can now understand why the entropy change is positive when ideal gases mix at constant T and p : Each substance occupies a greater *volume* in the final state than initially. Exactly the same entropy increase would result if the volume of each of the pure ideal gases were increased isothermally without mixing.

The reversible mixing process depicted in Fig. 11.3 illustrates this principle. The initial state shown in Fig. 11.3(a) consists of volume $V_1(A)$ of pure ideal gas A and volume $V_1(B)$ of pure ideal gas B, both at the same T and p . The hypothetical semipermeable pistons are moved apart reversibly and isothermally to create an ideal gas mixture, as shown in Fig. 11.3(b). According to an argument in Sec. 9.3.3, transfer equilibrium across the semipermeable pistons requires partial pressure p_A in the mixture to equal the pressure of the pure A at the left, and partial pressure p_B in the mixture to equal the pressure of the pure B at the right. Thus in intermediate states of the process, gas A exerts no net force on piston 1, and gas B exerts no net force on piston 2.

In the final state shown in Fig. 11.3(c), the gases are fully mixed in a phase of volume $V_2 = V_1(A) + V_1(B)$. The movement of piston 1 has expanded gas B with the same reversible work as if gas A were absent, equal to $-n_B RT \ln[V_2/V_1(B)]$. Likewise, the reversible work to expand gas A with piston 2 is the same as if B were absent: $-n_A RT \ln[V_2/V_1(A)]$. Because the initial and final temperatures and pressures are the same, the mole fractions in the final mixture are $y_A = V_1(A)/V_2$ and $y_B = V_1(B)/V_2$. The total work of the reversible

mixing process is therefore $w = n_A RT \ln y_A + n_B RT \ln y_B$, the heat needed to keep the internal energy constant is $q = -w$, and the entropy change is

$$\Delta S = q/T = -n_A R \ln y_A - n_B R \ln y_B \quad (11.1.26)$$

It should be clear that isothermal expansion of both pure gases from their initial volumes to volume V_2 without mixing would result in the same total work and the same entropy change.

When we divide Eq. 11.1.26 by $n = n_A + n_B$, we obtain the expression for the molar entropy of mixing given by Eq. 11.1.9 with x_i replaced by y_i for a gas.

11.1.5 Molecular model of a liquid mixture

We have seen that when two pure liquids mix to form an ideal liquid mixture at the same T and p , the total volume and internal energy do not change. A simple molecular model of a binary liquid mixture will elucidate the energetic molecular properties that are consistent with this macroscopic behavior. The model assumes the excess molar entropy, but not necessarily the excess molar internal energy, is zero. The model is of the type sometimes called the *quasicrystalline lattice model*, and the mixture it describes is sometimes called a *simple* mixture. Of course, a molecular model like this is outside the realm of classical thermodynamics.

The model is for substances A and B in gas and liquid phases at a fixed temperature. Let the standard molar internal energy of pure gaseous A be $U_A^\circ(\text{g})$. This is the molar energy in the absence of intermolecular interactions, and its value depends only on the molecular constitution and the temperature. The molar internal energy of pure liquid A is lower because of the attractive intermolecular forces in the liquid phase. We assume the energy difference is equal to a sum of pairwise nearest-neighbor interactions in the liquid. Thus, the molar internal energy of pure liquid A is given by

$$U_A^* = U_A^\circ(\text{g}) + k_{AA} \quad (11.1.27)$$

where k_{AA} (approximately the negative of the molar internal energy of vaporization) is the interaction energy per amount of A due to A–A interactions when each molecule of A is surrounded only by other molecules of A.

Similarly, the molar internal energy of pure liquid B is given by

$$U_B^* = U_B^\circ(\text{g}) + k_{BB} \quad (11.1.28)$$

where k_{BB} is for B–B interactions.

We assume that in a liquid mixture of A and B, the numbers of nearest-neighbor molecules of A and B surrounding any given molecule are in proportion to the mole fractions x_A and x_B .⁴ Then the number of A–A interactions is proportional to $n_A x_A$, the number of B–B interactions is proportional to $n_B x_B$, and the number of A–B interactions is proportional to $n_A x_B + n_B x_A$. The internal energy of the liquid mixture is then given by

$$U(\text{mixt}) = n_A U_A^\circ(\text{g}) + n_B U_B^\circ(\text{g}) + n_A x_A k_{AA} + n_B x_B k_{BB} + (n_A x_B + n_B x_A) k_{AB} \quad (11.1.29)$$

⁴This assumption requires the molecules of A and B to have similar sizes and shapes and to be randomly mixed in the mixture. Statistical mechanics theory shows that the molecular sizes must be approximately equal if the excess molar entropy is to be zero.

where k_{AB} is the interaction energy per amount of A when each molecule of A is surrounded only by molecules of B, or the interaction energy per amount of B when each molecule of B is surrounded only by molecules of A.

The internal energy change for mixing amounts n_A of liquid A and n_B of liquid B is now

$$\begin{aligned}\Delta U(\text{mix}) &= U(\text{mixt}) - n_A U_A^* - n_B U_B^* \\ &= n_A x_A k_{AA} + n_B x_B k_{BB} + (n_A x_B + n_B x_A) k_{AB} - n_A k_{AA} - n_B k_{BB} \\ &= n_A (x_A - 1) k_{AA} + n_B (x_B - 1) k_{BB} + (n_A x_B + n_B x_A) k_{AB}\end{aligned}\quad (11.1.30)$$

With the identities $x_A - 1 = -x_B$, $x_B - 1 = -x_A$, and $n_A x_B = n_B x_A = n_A n_B / n$ (where n is the sum $n_A + n_B$), we obtain

$$\Delta U(\text{mix}) = \frac{n_A n_B}{n} (2k_{AB} - k_{AA} - k_{BB}) \quad (11.1.31)$$

If the internal energy change to form a mixture of any composition is to be zero, as it is for an ideal mixture, the quantity $(2k_{AB} - k_{AA} - k_{BB})$ must be zero, which means k_{AB} must equal $(k_{AA} + k_{BB})/2$. Thus, one requirement for an ideal mixture is that *an A–B interaction equals the average of an A–A interaction and a B–B interaction*.

If we write Eq. 11.1.29 in the form

$$U(\text{mixt}) = n_A U_A^\circ(\text{g}) + n_B U_B^\circ(\text{g}) + \frac{1}{n_A + n_B} (n_A^2 k_{AA} + 2n_A n_B k_{AB} + n_B^2 k_{BB}) \quad (11.1.32)$$

we can differentiate with respect to n_B at constant n_A to evaluate the partial molar internal energy of B. The result can be rearranged to the simple form

$$U_B = U_B^* + (2k_{AB} - k_{AA} - k_{BB}) (1 - x_B)^2 \quad (11.1.33)$$

where U_B^* is given by Eq. 11.1.28. Equation 11.1.33 predicts that the value of U_B decreases with increasing x_B if k_{AB} is less negative than the average of k_{AA} and k_{BB} , increases for the opposite situation, and is equal to U_B^* in an ideal liquid mixture.

When the excess molar volume and entropy are set equal to zero, the model describes what is called a *regular solution*.⁵ The excess molar Gibbs energy of a mixture is $G_m^E = U_m^E + pV_m^E - TS_m^E$. Using the expression of Eq. 11.1.31 with the further assumptions that V_m^E and S_m^E are zero, this model predicts the excess molar Gibbs energy is given by

$$G_m^E = \frac{\Delta U(\text{mix})}{n} = x_A x_B (2k_{AB} - k_{AA} - k_{BB}) \quad (11.1.34)$$

This is a symmetric function of x_A and x_B . It predicts, for example, that coexisting liquid layers in a binary system (Sec. 11.1.6) have the same value of x_A in one phase as the value of x_B in the other.

Molar excess Gibbs energies of real liquid mixtures are often found to be unsymmetric functions. To represent them, a more general function is needed. A commonly used function for a binary mixture is the **Redlich–Kister series** given by

$$G_m^E = x_A x_B [a + b(x_A - x_B) + c(x_A - x_B)^2 + \dots] \quad (11.1.35)$$

⁵Ref. [86].

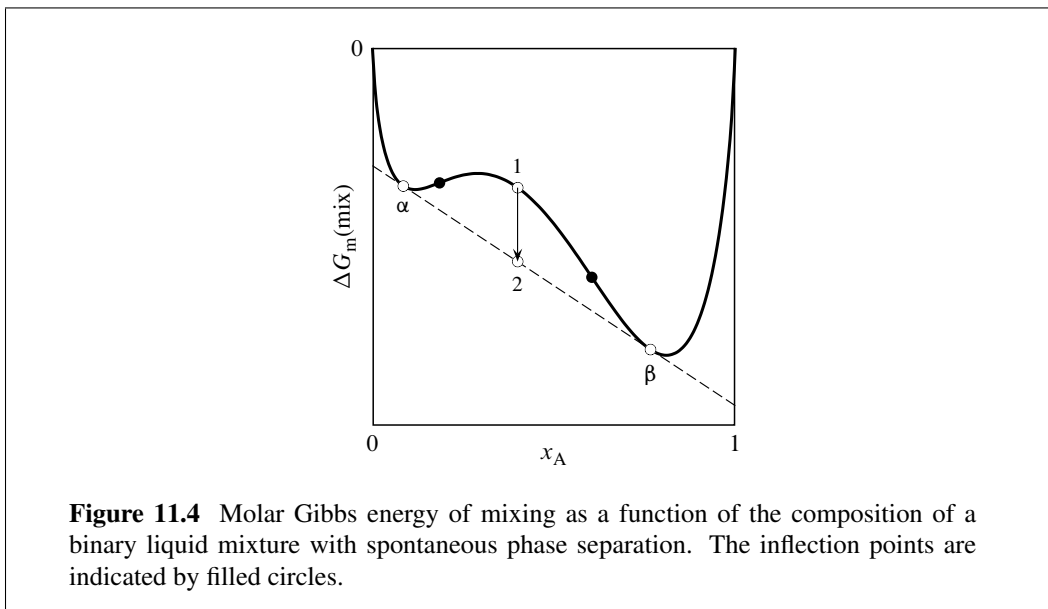

Figure 11.4 Molar Gibbs energy of mixing as a function of the composition of a binary liquid mixture with spontaneous phase separation. The inflection points are indicated by filled circles.

where the parameters a, b, c, \dots depend on T and p but not on composition. This function satisfies a necessary condition for the dependence of G_m^E on composition: G_m^E must equal zero when either x_A or x_B is zero.⁶

For many binary liquid systems, the measured dependence of G_m^E on composition is reproduced reasonably well by the two-parameter Redlich–Kister series

$$G_m^E = x_A x_B [a + b(x_A - x_B)] \quad (11.1.36)$$

in which the parameters a and b are adjusted to fit the experimental data. The activity coefficients in a mixture obeying this equation are found, from Eq. 11.1.20, to be given by

$$RT \ln \gamma_A = x_B^2 [a + (3 - 4x_B)b] \quad RT \ln \gamma_B = x_A^2 [a + (4x_A - 3)b] \quad (11.1.37)$$

11.1.6 Phase separation of a liquid mixture

A binary liquid mixture in a system maintained at constant T and p can spontaneously separate into two liquid layers if any part of the curve of a plot of $\Delta G_m(\text{mix})$ versus x_A is concave downward. To understand this phenomenon, consider Fig. 11.4. This figure is a plot of $\Delta G_m(\text{mix})$ versus x_A . It has the form needed to evaluate the quantities $(\mu_A - \mu_A^*)$ and $(\mu_B - \mu_B^*)$ by the variant of the method of intercepts described on page 236. On this plot, the tangent to the curve at any given composition has intercepts equal to $(\mu_B - \mu_B^*)$ at $x_A = 0$ and $(\mu_A - \mu_A^*)$ at $x_A = 1$.

In order for two binary liquid phases to be in transfer equilibrium, μ_A must be the same in both phases and μ_B must also be the same in both phases. The dashed line in the figure is a common tangent to the curve at the points labeled α and β . These two points are the only ones having a common tangent, and what makes the common tangent possible is the downward concavity (negative curvature) of a portion of the curve between these

⁶The reason for this condition can be seen by looking at Eq. 11.1.19 on page 308. For a binary mixture, this equation becomes $G_m^E = RT(x_A \ln \gamma_A + x_B \ln \gamma_B)$. When x_A is zero, γ_B is 1 and $\ln \gamma_B$ is zero. When x_B is zero, γ_A is 1 and $\ln \gamma_A$ is zero. Thus G_m^E must be zero in both cases.

points. Because the tangents at these points have the same intercepts, phases α and β of compositions x_A^α and x_A^β can be in equilibrium with one another: the necessary conditions $\mu_A^\alpha = \mu_A^\beta$ and $\mu_B^\alpha = \mu_B^\beta$ are satisfied.

Now consider point 1 on the curve. A phase of this composition is unstable. It will spontaneously separate into the two phases of compositions x_A^α and x_A^β , because the Gibbs energy per total amount then decreases to the extent indicated by the vertical arrow from point 1 to point 2. We know that a process in which G decreases at constant T and p in a closed system, with expansion work only, is a spontaneous process (Sec. 5.8).

To show that the arrow in Fig. 11.4 represents the change in G/n for phase separation, we let y represent the vertical ordinate and write the equation of the dashed line through points α and β (y as a function of x_A):

$$y = y^\alpha + \left(\frac{y^\beta - y^\alpha}{x_A^\beta - x_A^\alpha} \right) (x_A - x_A^\alpha) \quad (11.1.38)$$

In the system both before and after phase separation occurs, x_A is the mole fraction of component A in the system as a whole. When phases α and β are present, containing amounts n^α and n^β , x_A is given by the expression

$$x_A = \frac{x_A^\alpha n^\alpha + x_A^\beta n^\beta}{n^\alpha + n^\beta} \quad (11.1.39)$$

By substituting this expression for x_A in Eq. 11.1.38, after some rearrangement and using $n^\alpha + n^\beta = n$, we obtain

$$y = \frac{1}{n} (n^\alpha y^\alpha + n^\beta y^\beta) \quad (11.1.40)$$

which equates y for a point on the dashed line to the Gibbs energy change for mixing pure components to form an amount n^α of phase α and an amount n^β of phase β , divided by the total amount n . Thus, the difference between the values of y at points 1 and 2 is the decrease in G/n when a single phase separates into two equilibrated phases.

Any mixture with a value of x_A between x_A^α and x_A^β is unstable with respect to separation into two phases of compositions x_A^α and x_A^β . Phase separation occurs only if the curve of the plot of $\Delta G_m(\text{mix})$ versus x_A is concave downward, which requires the curve to have at least two inflection points. The compositions of the two phases are not the compositions at the inflection points, nor in the case of the curve shown in Fig. 11.4 are these compositions the same as those of the two local minima.

By varying the values of parameters in an expression for the excess molar Gibbs energy, we can model the onset of phase separation caused by a temperature change. Figure 11.5 shows the results of using the two-parameter Redlich–Kister series (Eq. 11.1.36).

If the properties of the mixture are such that G_m^E is positive at each mixture composition (except at the extremes $x_A=0$ and $x_A=1$ where it must be zero), and no portion of the curve of $\Delta G_m(\text{mix})$ versus x_A is concave downward, there can be no phase separation and the activity a_A increases monotonically with x_A . This case is illustrated by curve 2 in Figs. 11.5(a) and 11.5(b).

If a portion of the $\Delta G_m(\text{mix})$ – x_A curve is concave downward, the condition needed for phase separation, then a maximum appears in the curve of a_A versus x_A . This case

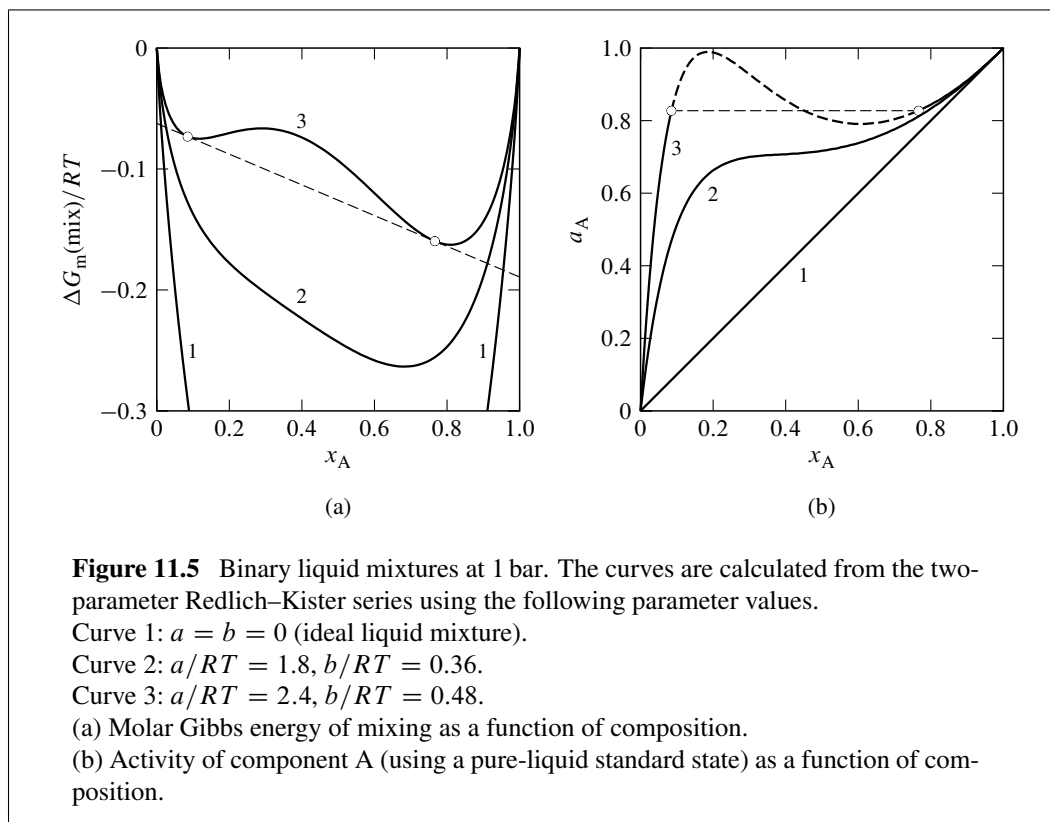

is illustrated by curve 3, and the compositions of the coexisting phases are indicated by open circles. The difference of the compositions at the two circles is a *miscibility gap*. The portion of curve 3 between these compositions in Fig. 11.5(b) is dashed to indicate it describes unstable, nonequilibrium states. Although the two coexisting phases have different compositions, the activity a_A is the same in both phases, as indicated in Fig. 11.5(b) by the horizontal dashed line. This is because component A has the same standard state and the same chemical potential in both phases.

Coexisting liquid phases will be discussed further in Secs. 12.6 and 13.2.3.

11.2 The Advancement and Molar Reaction Quantities

Many of the processes of interest to chemists can be described by balanced reaction equations, or chemical equations, for the conversion of reactants into products. Thus, for the vaporization of water we write

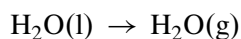

For the dissolution of sodium chloride in water, we write

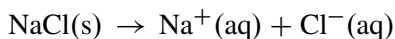

For the Haber synthesis of ammonia, the reaction equation can be written

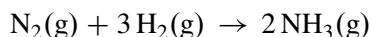

The essential feature of a reaction equation is that equal amounts of each element and equal net charges appear on both sides; the equation is said to be *balanced*. Thus, matter and charge are conserved during the process, and the process can take place in a closed system. The species to the left of a single arrow are called *reactants*, the species to the right are called *products*, and the arrow indicates the *forward* direction of the process.

A reaction equation is sometimes written with right and left arrows



to indicate that the process is at reaction equilibrium. It can also be written as a *stoichiometric equation* with an equal sign:

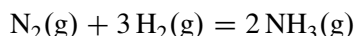

A reaction equation shows stoichiometric relations among the reactants and products. It is important to keep in mind that it specifies neither the initial and final states of a chemical process, nor the change in the amount of a reactant or product during the process. For example, the reaction equation $\text{N}_2 + 3 \text{H}_2 \rightarrow 2 \text{NH}_3$ does not imply that the system initially contains only N_2 and H_2 , or that only NH_3 is present in the final state; and it does not mean that the process consists of the conversion of exactly one mole of N_2 and three moles of H_2 to two moles of NH_3 (although this is a possibility). Instead, the reaction equation tells us that a change in the amount of N_2 is accompanied by three times this change in the amount of H_2 and by twice this change, with the opposite sign, in the amount of NH_3 .

11.2.1 An example: ammonia synthesis

It is convenient to indicate the progress of a chemical process with a variable called the *advancement*. The reaction equation $\text{N}_2 + 3 \text{H}_2 \rightarrow 2 \text{NH}_3$ for the synthesis of ammonia synthesis will serve to illustrate this concept. Let the system be a gaseous mixture of N_2 , H_2 , and NH_3 .

If the system is *open* and the intensive properties remain uniform throughout the gas mixture, there are five independent variables. We can choose them to be T , p , and the amounts of the three substances. We can write the total differential of the enthalpy, for instance, as

$$\begin{aligned} dH = & \left(\frac{\partial H}{\partial T} \right)_{p, \{n_i\}} dT + \left(\frac{\partial H}{\partial p} \right)_{T, \{n_i\}} dp \\ & + H_{\text{N}_2} dn_{\text{N}_2} + H_{\text{H}_2} dn_{\text{H}_2} + H_{\text{NH}_3} dn_{\text{NH}_3} \end{aligned} \quad (11.2.1)$$

The notation $\{n_i\}$ stands for the set of amounts of all substances in the mixture, and the quantities H_{N_2} , H_{H_2} , and H_{NH_3} are partial molar enthalpies. For example, H_{N_2} is defined by

$$H_{\text{N}_2} = \left(\frac{\partial H}{\partial n_{\text{N}_2}} \right)_{T, p, n_{\text{H}_2}, n_{\text{NH}_3}} \quad (11.2.2)$$

If the system is *closed*, the amounts of the three substances can still change because of the reaction $\text{N}_2 + 3 \text{H}_2 \rightarrow 2 \text{NH}_3$, and the number of independent variables is reduced from five to three. We can choose them to be T , p , and a variable called advancement.

The **advancement** (or extent of reaction), ξ , is the amount by which the reaction defined by the reaction equation has advanced in the forward direction from specified initial conditions. The quantity ξ has dimensions of amount of substance, the usual unit being the mole.

Let the initial amounts be $n_{\text{N}_2,0}$, $n_{\text{H}_2,0}$, and $n_{\text{NH}_3,0}$. Then at any stage of the reaction process in the closed system, the amounts are given by

$$n_{\text{N}_2} = n_{\text{N}_2,0} - \xi \quad n_{\text{H}_2} = n_{\text{H}_2,0} - 3\xi \quad n_{\text{NH}_3} = n_{\text{NH}_3,0} + 2\xi \quad (11.2.3)$$

These relations come from the stoichiometry of the reaction as expressed by the stoichiometric coefficients in the reaction equation. The second relation, for example, expresses the fact that when one mole of reaction has occurred ($\xi = 1$ mol), the amount of H_2 in the closed system has decreased by three moles.

Taking the differentials of Eqs. 11.2.3, we find that infinitesimal changes in the amounts are related to the change of ξ as follows:

$$dn_{\text{N}_2} = -d\xi \quad dn_{\text{H}_2} = -3d\xi \quad dn_{\text{NH}_3} = 2d\xi \quad (11.2.4)$$

These relations show that in a closed system, the changes in the various amounts are not independent. Substitution in Eq. 11.2.1 of the expressions for dn_{N_2} , dn_{H_2} , and dn_{NH_3} gives

$$\begin{aligned} dH = & \left(\frac{\partial H}{\partial T} \right)_{p, \xi} dT + \left(\frac{\partial H}{\partial p} \right)_{T, \xi} dp \\ & + (-H_{\text{N}_2} - 3H_{\text{H}_2} + 2H_{\text{NH}_3}) d\xi \end{aligned} \quad (11.2.5)$$

(closed system)

(The subscript $\{n_i\}$ on the partial derivatives has been replaced by ξ to indicate the same thing: that the derivative is taken with the amount of each species held constant.)

Equation 11.2.5 gives an expression for the total differential of the enthalpy with T , p , and ξ as the independent variables. The coefficient of $d\xi$ in this equation is called the **molar reaction enthalpy**, or molar enthalpy of reaction, $\Delta_r H$:

$$\Delta_r H = -H_{\text{N}_2} - 3H_{\text{H}_2} + 2H_{\text{NH}_3} \quad (11.2.6)$$

We identify this coefficient as the partial derivative

$$\Delta_r H = \left(\frac{\partial H}{\partial \xi} \right)_{T, p} \quad (11.2.7)$$

That is, the molar reaction enthalpy is the rate at which the enthalpy changes with the advancement as the reaction proceeds in the forward direction at constant T and p .

The partial molar enthalpy of a species is the enthalpy change per amount of the species added to an *open* system. To see why the particular combination of partial molar enthalpies on the right side of Eq. 11.2.6 is the rate at which enthalpy changes with advancement in the *closed* system, we can imagine the following process at constant T and p : An infinitesimal amount dn of N_2 is removed from an open system, three times this amount of H_2 is removed from the same system, and twice this amount of NH_3 is added to the system. The total enthalpy change in the open system is $dH = (-H_{\text{N}_2} - 3H_{\text{H}_2} + 2H_{\text{NH}_3}) dn$. The net change in the state of the system is equivalent to an advancement $d\xi = dn$ in a closed system, so $dH/d\xi$ in the closed system is equal to $(-H_{\text{N}_2} - 3H_{\text{H}_2} + 2H_{\text{NH}_3})$ in agreement with Eqs. 11.2.6 and 11.2.7.

Note that because the advancement is defined by how we write the reaction equation, the value of $\Delta_r H$ also depends on the reaction equation. For instance, if we change the reaction equation for ammonia synthesis from $\text{N}_2 + 3 \text{H}_2 \rightarrow 2 \text{NH}_3$ to

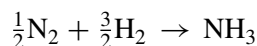

then the value of $\Delta_r H$ is halved.

11.2.2 Molar reaction quantities in general

Now let us generalize the relations of the preceding section for any chemical process in a closed system. Suppose the stoichiometric equation has the form



where A and B are reactant species, D and E are product species, and a , b , d , and e are the corresponding stoichiometric coefficients. We can rearrange this equation to

$$0 = -aA - bB + dD + eE \quad (11.2.9)$$

In general, the stoichiometric relation for any chemical process is

$$0 = \sum_i \nu_i A_i \quad (11.2.10)$$

where ν_i is the **stoichiometric number** of species A_i , a dimensionless quantity taken as negative for a reactant and positive for a product. In the ammonia synthesis example of the previous section, the stoichiometric relation is $0 = -\text{N}_2 - 3\text{H}_2 + 2\text{NH}_3$ and the stoichiometric numbers are $\nu_{\text{N}_2} = -1$, $\nu_{\text{H}_2} = -3$, and $\nu_{\text{NH}_3} = +2$. In other words, each stoichiometric number is the same as the stoichiometric coefficient in the reaction equation, except that the sign is negative for a reactant.

The amount of reactant or product species i present in the closed system at any instant depends on the advancement at that instant, and is given by

$$n_i = n_{i,0} + \nu_i \xi \quad (11.2.11)$$

(closed system)

The infinitesimal change in the amount due to an infinitesimal change in the advancement is

$$dn_i = \nu_i d\xi \quad (11.2.12)$$

(closed system)

In an open system, the total differential of extensive property X is

$$dX = \left(\frac{\partial X}{\partial T} \right)_{p, \{n_i\}} dT + \left(\frac{\partial X}{\partial p} \right)_{T, \{n_i\}} dp + \sum_i X_i dn_i \quad (11.2.13)$$

where X_i is a partial molar quantity. We restrict the system to a closed one with T , p , and ξ as the independent variables. Then, with the substitution $dn_i = \nu_i d\xi$ from Eq. 11.2.12, the total differential of X becomes

$$dX = \left(\frac{\partial X}{\partial T} \right)_{p, \xi} dT + \left(\frac{\partial X}{\partial p} \right)_{T, \xi} dp + \Delta_r X d\xi \quad (11.2.14)$$

(closed system)

where the coefficient $\Delta_r X$ is the **molar reaction quantity** defined by

$$\Delta_r X \stackrel{\text{def}}{=} \sum_i \nu_i X_i \quad (11.2.15)$$

Equation 11.2.14 allows us to identify the molar reaction quantity as a partial derivative:

$$\Delta_r X = \left(\frac{\partial X}{\partial \xi} \right)_{T,p} \quad (11.2.16)$$

(closed system)

It is important to observe the distinction between the notations ΔX , the finite change of X during a process, and $\Delta_r X$, a differential quantity that is a property of the system in a given state. The fact that both notations use the symbol Δ can be confusing. Equation 11.2.16 shows that we can think of Δ_r as an *operator*.

In dealing with the change of an extensive property X as ξ changes, we must distinguish between molar integral and molar differential reaction quantities.

- $\Delta X/\Delta \xi$ is a molar *integral* reaction quantity, the ratio of two finite differences between the final and initial states of a process. These states are assumed to have the same temperature and the same pressure. This book will use a notation such as $\Delta H_m(\text{rxn})$ for a molar integral reaction enthalpy:

$$\Delta H_m(\text{rxn}) = \frac{\Delta H(\text{rxn})}{\Delta \xi} = \frac{H(\xi_2) - H(\xi_1)}{\xi_2 - \xi_1} \quad (11.2.17)$$

($T_2=T_1, p_2=p_1$)

- $\Delta_r X$ is a molar *differential* reaction quantity. Equation 11.2.16 shows that $\Delta_r X$ is the rate at which the extensive property X changes with the advancement in a closed system at constant T and p . The value of $\Delta_r X$ is in general a function of the independent variables T , p , and ξ .

The notation for a molar differential reaction quantity such as $\Delta_r H$ includes a subscript following the Δ symbol to indicate the kind of chemical process. The subscript “r” denotes a reaction or process in general. The meanings of “vap,” “sub,” “fus,” and “trs” were described in Sec. 8.3.1. Subscripts for specific kinds of reactions and processes are listed in Sec. D.2 of Appendix D and are illustrated in sections to follow.

For certain kinds of processes, it may happen that a partial molar quantity X_i remains constant for each species i as the process advances at constant T and p . If X_i remains constant for each i , then according to Eq. 11.2.15 the value of $\Delta_r X$ must also remain constant as the process advances. Since $\Delta_r X$ is the rate at which X changes with ξ , in such a situation X is a linear function of ξ . This means that the molar integral reaction quantity $\Delta X_m(\text{rxn})$ defined by $\Delta X/\Delta \xi$ is equal, for any finite change of ξ , to $\Delta_r X$.

An example is the partial molar enthalpy H_i of a constituent of an ideal gas mixture, an ideal condensed-phase mixture, or an ideal-dilute solution. In these ideal mixtures, H_i is independent of composition at constant T and p (Secs. 9.3.3, 9.4.3, and 9.4.7). When a reaction takes place at constant T and p in one of these mixtures, the molar differential reaction enthalpy $\Delta_r H$ is constant during the process, H is a linear function of ξ , and $\Delta_r H$ and $\Delta H_m(\text{rxn})$ are equal. Figure 11.6(a) on the next page illustrates this linear dependence for a reaction in an ideal gas mixture.

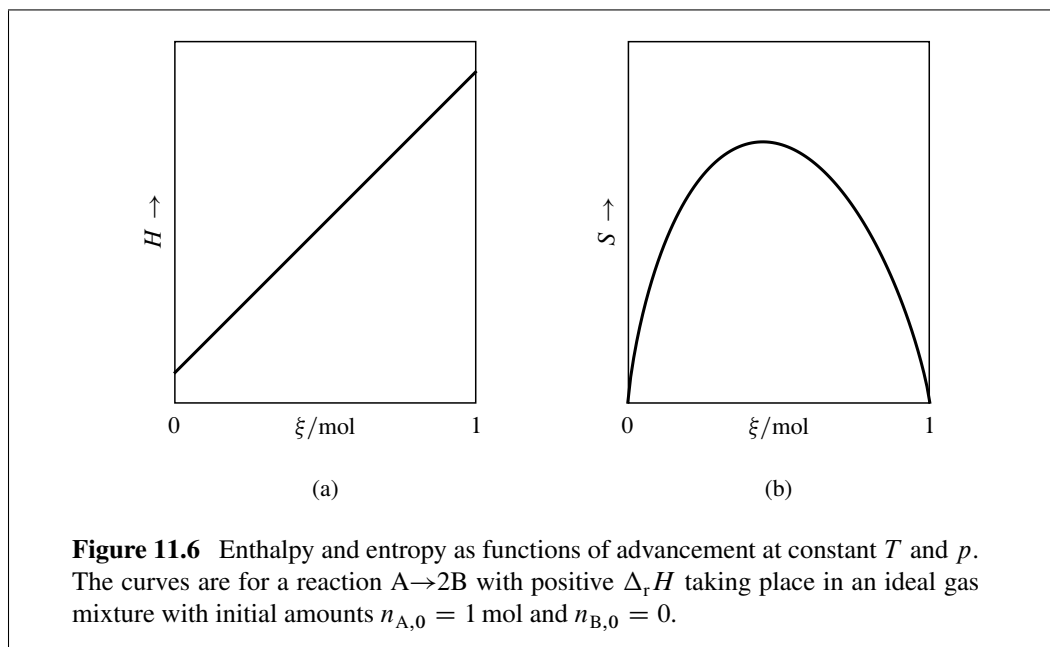

In contrast, Fig. 11.6(b) shows the nonlinearity of the entropy as a function of ξ during the same reaction. The nonlinearity is a consequence of the dependence of the partial molar entropy S_i on the mixture composition (Eq. 11.1.24). In the figure, the slope of the curve at each value of ξ equals $\Delta_r S$ at that point; its value changes as the reaction advances and the composition of the reaction mixture changes. Consequently, the molar integral reaction entropy $\Delta S_m(\text{rxn}) = \Delta S(\text{rxn})/\Delta\xi$ approaches the value of $\Delta_r S$ only in the limit as $\Delta\xi$ approaches zero.

11.2.3 Standard molar reaction quantities

If a chemical process takes place at constant temperature while each reactant and product remains in its standard state of unit activity, the molar reaction quantity $\Delta_r X$ is called the **standard molar reaction quantity** and is denoted by $\Delta_r X^\circ$. For instance, $\Delta_{\text{vap}} H^\circ$ is a standard molar enthalpy of vaporization (already discussed in Sec. 8.3.3), and $\Delta_r G^\circ$ is the standard molar Gibbs energy of a reaction.

From Eq. 11.2.15, the relation between a standard molar reaction quantity and the standard molar quantities of the reactants and products at the same temperature is

$$\Delta_r X^\circ \stackrel{\text{def}}{=} \sum_i \nu_i X_i^\circ \quad (11.2.18)$$

Two comments are in order.

1. Whereas a molar reaction quantity is usually a function of T , p , and ξ , a *standard* molar reaction quantity is a function only of T . This is evident because standard-state conditions imply that each reactant and product is in a separate phase of constant defined composition and constant pressure p° .

2. Since the value of a standard molar reaction quantity is independent of ξ , the standard molar integral and differential quantities are identical (page 318):

$$\Delta X_m^\circ(\text{rxn}) = \Delta_r X^\circ \quad (11.2.19)$$

These general concepts will now be applied to some specific chemical processes.

11.3 Molar Reaction Enthalpy

Recall that $\Delta H_m(\text{rxn})$ is a molar integral reaction enthalpy equal to $\Delta H(\text{rxn})/\Delta\xi$, and that $\Delta_r H$ is a molar differential reaction enthalpy defined by $\sum_i \nu_i H_i$ and equal to $(\partial H/\partial \xi)_{T,p}$.

11.3.1 Molar reaction enthalpy and heat

During a process in a closed system at constant pressure with expansion work only, the enthalpy change equals the energy transferred across the boundary in the form of heat: $dH = \delta q$ (Eq. 5.3.7). Thus for the molar reaction enthalpy $\Delta_r H = (\partial H/\partial \xi)_{T,p}$, which refers to a process not just at constant pressure but also at constant temperature, we can write

$$\Delta_r H = \frac{\delta q}{d\xi} \quad (11.3.1)$$

(constant T and p , $\delta w' = 0$)

Note that when there is nonexpansion work (w'), such as electrical work, the enthalpy change is not equal to the heat. For example, if we compare a reaction taking place in a galvanic cell with the same reaction in a reaction vessel, the heats at constant T and p for a given change of ξ are different, and may even have opposite signs. The value of $\Delta_r H$ is the same in both systems, but the ratio of heat to advancement, $\delta q/d\xi$, is different.

An **exothermic** reaction is one for which $\Delta_r H$ is negative, and an **endothermic** reaction is one for which $\Delta_r H$ is positive. Thus in a reaction at constant temperature and pressure with expansion work only, heat is transferred out of the system during an exothermic process and into the system during an endothermic process. If the process takes place at constant pressure in a system with thermally-insulated walls, the temperature increases during an exothermic process and decreases during an endothermic process.

These comments apply not just to chemical reactions, but to the other chemical processes at constant temperature and pressure discussed in this chapter.

11.3.2 Standard molar enthalpies of reaction and formation

A **standard molar reaction enthalpy**, $\Delta_r H^\circ$, is the same as the molar integral reaction enthalpy $\Delta H_m(\text{rxn})$ for the reaction taking place under standard state conditions (each reactant and product at unit activity) at constant temperature (page 319).

At constant temperature, partial molar enthalpies depend only mildly on pressure. It is therefore usually safe to assume that unless the experimental pressure is much greater than p° , the reaction is exothermic if $\Delta_r H^\circ$ is negative and endothermic if $\Delta_r H^\circ$ is positive.

The **formation reaction** of a substance is the reaction in which the substance, at a given temperature and in a given physical state, is formed from the constituent elements in their reference states at the same temperature. The *reference state of an element* is usually chosen

to be the standard state of the element in the allotropic form and physical state that is stable at the given temperature and the standard pressure. For instance, at 298.15 K and 1 bar the stable allotrope of carbon is crystalline graphite rather than diamond.

Phosphorus is an exception to the rule regarding reference states of elements. Although red phosphorus is the stable allotrope at 298.15 K, it is not well characterized. Instead, the reference state is white phosphorus (crystalline P_4) at 1 bar.

At 298.15 K, the reference states of the elements are the following:

- For H_2 , N_2 , O_2 , F_2 , Cl_2 , and the noble gases, the reference state is the ideal gas at 1 bar.
- For Br_2 and Hg, the reference state is the liquid at 1 bar.
- For P, as mentioned above, the reference state is crystalline white phosphorus at 1 bar.
- For all other elements, the reference state is the stable crystalline allotrope at 1 bar.

The **standard molar enthalpy of formation** (or standard molar heat of formation), $\Delta_f H^\circ$, of a substance is the enthalpy change per amount of substance produced in the formation reaction of the substance in its standard state. Thus, the standard molar enthalpy of formation of gaseous methyl bromide at 298.15 K is the molar reaction enthalpy of the reaction

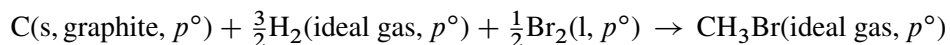

The value of $\Delta_f H^\circ$ for a given substance depends only on T . By definition, $\Delta_f H^\circ$ for the reference state of an element is zero.

A principle called **Hess's law** can be used to calculate the standard molar enthalpy of formation of a substance at a given temperature from standard molar reaction enthalpies at the same temperature, and to calculate a standard molar reaction enthalpy from tabulated values of standard molar enthalpies of formation. The principle is an application of the fact that enthalpy is a state function. Therefore, ΔH for a given change of the state of the system is independent of the path and is equal to the sum of ΔH values for any sequence of changes whose net result is the given change. (We may apply the same principle to a change of *any* state function.)

For example, the following combustion reactions can be carried out experimentally in a bomb calorimeter (Sec. 11.5.2), yielding the values shown below of standard molar reaction enthalpies (at $T = 298.15$ K, $p = p^\circ = 1$ bar):

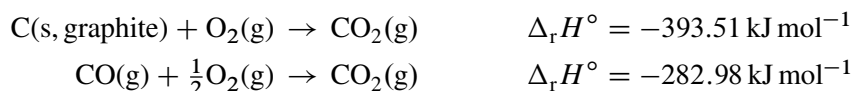

(Note that the first reaction, in addition to being the combustion reaction of graphite, is also the formation reaction of carbon dioxide.) The change resulting from the first reaction followed by the reverse of the second reaction is the formation reaction of carbon monoxide:

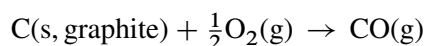

It would not be practical to measure the molar enthalpy of this last reaction by allowing graphite to react with oxygen in a calorimeter, because it would be difficult to prevent the formation of some CO_2 . From Hess's law, the standard molar enthalpy of formation of CO

is the sum of the standard molar enthalpies of the reactions that have the formation reaction as the net result:

$$\begin{aligned}\Delta_f H^\circ(\text{CO, g, 298.15 K}) &= (-393.51 + 282.98) \text{ kJ mol}^{-1} \\ &= -110.53 \text{ kJ mol}^{-1}\end{aligned}\quad (11.3.2)$$

This value is one of the many standard molar enthalpies of formation to be found in compilations of thermodynamic properties of individual substances, such as the table in Appendix H. We may use the tabulated values to evaluate the standard molar reaction enthalpy $\Delta_r H^\circ$ of a reaction using a formula based on Hess's law. Imagine the reaction to take place in two steps: First each reactant in its standard state changes to the constituent elements in their reference states (the reverse of a formation reaction), and then these elements form the products in their standard states. The resulting formula is

$$\Delta_r H^\circ = \sum_i \nu_i \Delta_f H^\circ(i) \quad (11.3.3)$$

(Hess's law)

where $\Delta_f H^\circ(i)$ is the standard molar enthalpy of formation of substance i . Recall that the stoichiometric number ν_i of each reactant is negative and that of each product is positive, so according to Hess's law the standard molar reaction enthalpy is the sum of the standard molar enthalpies of formation of the products minus the sum of the standard molar enthalpies of formation of the reactants. Each term is multiplied by the appropriate stoichiometric coefficient from the reaction equation.

A standard molar enthalpy of formation can be defined for a *solute in solution* to use in Eq. 11.3.3. For instance, the formation reaction of aqueous sucrose is

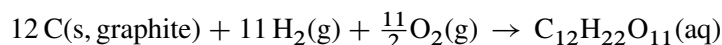

and $\Delta_f H^\circ$ for $\text{C}_{12}\text{H}_{22}\text{O}_{11}(\text{aq})$ is the enthalpy change per amount of sucrose formed when the reactants and product are in their standard states. Note that this formation reaction does *not* include the formation of the solvent H_2O from H_2 and O_2 . Instead, the solute once formed combines with the amount of pure liquid water needed to form the solution. If the aqueous solute is formed in its standard state, the amount of water needed is very large so as to have the solute exhibit infinite-dilution behavior.

There is no ordinary reaction that would produce an individual *ion in solution* from its element or elements without producing other species as well. We can, however, prepare a consistent set of standard molar enthalpies of formation of ions by assigning a value to a single reference ion.⁷ We can use these values for ions in Eq. 11.3.3 just like values of $\Delta_f H^\circ$ for substances and nonionic solutes. Aqueous hydrogen ion is the usual reference ion, to which is assigned the arbitrary value

$$\Delta_f H^\circ(\text{H}^+, \text{aq}) = 0 \quad (\text{at all temperatures}) \quad (11.3.4)$$

To see how we can use this reference value, consider the reaction for the formation of aqueous HCl (hydrochloric acid):

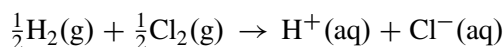

⁷This procedure is similar to that described on page 236 for partial molar volumes of ions.

BIOGRAPHICAL SKETCH

Germain Henri Hess (1802–1850)



Hess was a Russian chemist and physician whose calorimetric measurements led him to formulate the law of constant heat summation, now known as Hess's law. His given name had several versions: "Germain Henri" in French, as shown above; "Hermann Heinrich" in German; and "German Iwanowitsch" in Russian.

He was born in Geneva, Switzerland, the son of an artist. The family moved to Russia when he was three years old; his father had found work there as a tutor on an estate. Hess studied medicine at the University of Tartu in Estonia (then part of the Russian empire) and received his doctor of medicine degree in 1825. In addition to his medical studies, Hess took courses in chemistry and geology and wrote a doctoral dissertation on the composition of mineral waters in Russia.^a

Hess was more interested in chemistry than medicine. He briefly studied with the famous Swedish chemist Jöns Jakob Berzelius in Stockholm, and they became life-long friends. Hess then practiced medicine in Irkutsk, Siberia, while continuing his interests in mineral chemistry and chemical analysis.

In 1829, after being elected an adjunct member of the St. Petersburg Academy of Sciences, he gave up his medical practice and began teaching chemistry at various institutions of higher learning in St. Petersburg. He wrote a two-volume textbook, *Fundamentals of Pure Chemistry*, in 1831, followed by a one-volume abridgment in 1834 that became the standard Russian chemistry textbook and went through

seven editions. He became a full member of the St. Petersburg Academy in 1834.

Hess published the results of his thermochemical research between 1839 and 1842. His 1840 paper^b describes his measurements of the heat evolved when pure sulfuric acid, H_2SO_4 , is mixed with various amounts of water, and another series of measurements of the heat evolved when the acid in H_2SO_4 -water mixtures is neutralized with aqueous ammonia. The following table from this paper is of historical interest, although it is a bit difficult to decipher:

Acid	Heat evolved by ammonia	water	Sum
$\dot{\text{H}}\ddot{\text{S}}$	595.8		595.8
$\dot{\text{H}}^2\ddot{\text{S}}$	518.9	77.8	596.7
$\dot{\text{H}}^3\ddot{\text{S}}$	480.5	116.7	597.2
$\dot{\text{H}}^6\ddot{\text{S}}$	446.2	155.6	601.8
		Average	597.9

The first column gives the relative amounts of acid and water in the notation of Berzelius: $\dot{\text{H}}$ is H_2O , $\ddot{\text{S}}$ is SO_3 , and $\dot{\text{H}}\ddot{\text{S}}$ is H_2SO_4 . Thus $\dot{\text{H}}^3\ddot{\text{S}}$, for example, is $\text{H}_2\text{SO}_4 + 2\text{H}_2\text{O}$. The second and third columns show the heat evolved ($-q$) in units of calories per gram of the SO_3 moiety of the H_2SO_4 . The near-equality of the sums in the last column for the overall reaction $\text{H}_2\text{SO}_4(\text{l}) + 2\text{NH}_3(\text{aq}) \rightarrow (\text{NH}_4)_2\text{SO}_4(\text{aq})$ demonstrates Hess's law of constant heat summation, which he stated in the words:^c

The amount of heat evolved during the formation of a given compound is constant, independent of whether the compound is formed directly or indirectly in a series of steps.

Hess confirmed this law with similar experiments using other acids such as $\text{HCl}(\text{aq})$ and other bases such as $\text{NaOH}(\text{aq})$ and $\text{CaO}(\text{s})$.

After 1848 Hess's health began to deteriorate. He was only 48 when he died. His role as the real founder of thermochemistry was largely forgotten until the influential German physical chemist Wilhelm Ostwald drew attention to it about forty years after Hess's death.

^aRefs. [101] and [107]. ^bRef. [84]. ^cRef. [84]; translation in Ref. [41].

The standard molar reaction enthalpy at 298.15 K for this reaction is known, from reaction calorimetry, to have the value $\Delta_r H^\circ = -167.08 \text{ kJ mol}^{-1}$. The standard states of the gaseous H_2 and Cl_2 are, of course, the pure gases acting ideally at pressure p° , and the standard state of each of the aqueous ions is the ion at the standard molality and standard pressure, acting as if its activity coefficient on a molality basis were 1. From Eq. 11.3.3, we equate the value of $\Delta_r H^\circ$ to the sum

$$-\frac{1}{2}\Delta_f H^\circ(\text{H}_2, \text{g}) - \frac{1}{2}\Delta_f H^\circ(\text{Cl}_2, \text{g}) + \Delta_f H^\circ(\text{H}^+, \text{aq}) + \Delta_f H^\circ(\text{Cl}^-, \text{aq})$$

But the first three terms of this sum are zero. Therefore, the value of $\Delta_f H^\circ(\text{Cl}^-, \text{aq})$ is $-167.08 \text{ kJ mol}^{-1}$.

Next we can combine this value of $\Delta_f H^\circ(\text{Cl}^-, \text{aq})$ with the measured standard molar enthalpy of formation of aqueous sodium chloride

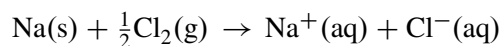

to evaluate the standard molar enthalpy of formation of aqueous sodium ion. By continuing this procedure with other reactions, we can build up a consistent set of $\Delta_f H^\circ$ values of various ions in aqueous solution.

11.3.3 Molar reaction heat capacity

The molar reaction enthalpy $\Delta_r H$ is in general a function of T , p , and ξ . Using the relations $\Delta_r H = \sum_i \nu_i H_i$ (from Eq. 11.2.15) and $C_{p,i} = (\partial H_i / \partial T)_{p,\xi}$ (Eq. 9.2.52), we can write

$$\left(\frac{\partial \Delta_r H}{\partial T}\right)_{p,\xi} = \left(\frac{\partial \sum_i \nu_i H_i}{\partial T}\right)_{p,\xi} = \sum_i \nu_i C_{p,i} = \Delta_r C_p \quad (11.3.5)$$

where $\Delta_r C_p$ is the molar reaction heat capacity at constant pressure, equal to the rate at which the heat capacity C_p changes with ξ at constant T and p .

Under standard state conditions, Eq. 11.3.5 becomes

$$d\Delta_r H^\circ / dT = \Delta_r C_p^\circ \quad (11.3.6)$$

11.3.4 Effect of temperature on reaction enthalpy

Consider a reaction occurring with a certain finite change of the advancement in a closed system at temperature T' and at constant pressure. The reaction is characterized by a change of the advancement from ξ_1 to ξ_2 , and the integral reaction enthalpy at this temperature is denoted $\Delta H(\text{rxn}, T')$. We wish to find an expression for the reaction enthalpy $\Delta H(\text{rxn}, T'')$ for the same values of ξ_1 and ξ_2 at the same pressure but at a different temperature, T'' .

The heat capacity of the system at constant pressure is related to the enthalpy by Eq. 5.6.3 on page 147: $C_p = (\partial H / \partial T)_{p,\xi}$. We integrate $dH = C_p dT$ from T' to T'' at constant p and ξ , for both the final and initial values of the advancement:

$$H(\xi_2, T'') = H(\xi_2, T') + \int_{T'}^{T''} C_p(\xi_2) dT \quad (11.3.7)$$

$$H(\xi_1, T'') = H(\xi_1, T') + \int_{T'}^{T''} C_p(\xi_1) dT \quad (11.3.8)$$

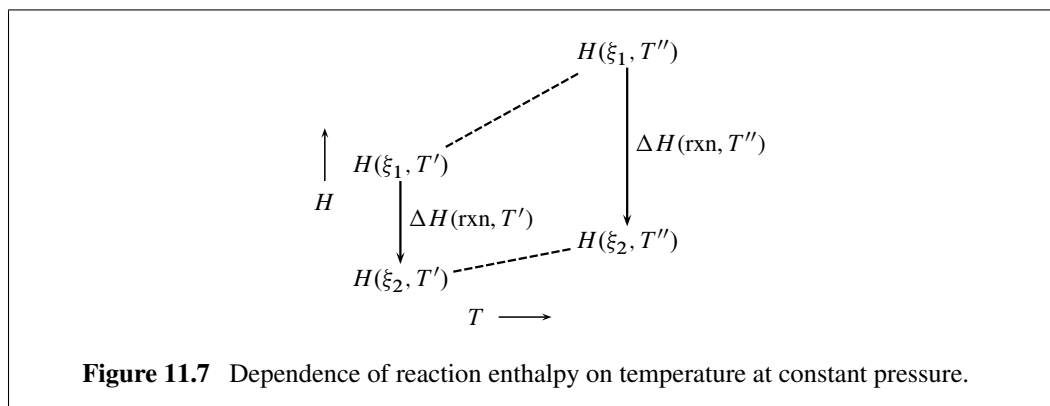

Subtracting Eq. 11.3.8 from Eq. 11.3.7, we obtain

$$\Delta H(\text{rxn}, T'') = \Delta H(\text{rxn}, T') + \int_{T'}^{T''} \Delta C_p \, dT \quad (11.3.9)$$

where ΔC_p is the difference between the heat capacities of the system at the final and initial values of ξ , a function of T : $\Delta C_p = C_p(\xi_2) - C_p(\xi_1)$. Equation 11.3.9 is the **Kirchhoff equation**.

When ΔC_p is essentially constant in the temperature range from T' to T'' , the Kirchhoff equation becomes

$$\Delta H(\text{rxn}, T'') = \Delta H(\text{rxn}, T') + \Delta C_p(T'' - T') \quad (11.3.10)$$

Figure 11.7 illustrates the principle of the Kirchhoff equation as expressed by Eq. 11.3.10. ΔC_p equals the difference in the slopes of the two dashed lines in the figure, and the product of ΔC_p and the temperature difference $T'' - T'$ equals the change in the value of $\Delta H(\text{rxn})$. The figure illustrates an exothermic reaction with negative ΔC_p , resulting in a more negative value of $\Delta H(\text{rxn})$ at the higher temperature.

We can also find the effect of temperature on the molar differential reaction enthalpy $\Delta_r H$. From Eq. 11.3.5, we have $(\partial \Delta_r H / \partial T)_{p, \xi} = \Delta_r C_p$. Integration from temperature T' to temperature T'' yields the relation

$$\Delta_r H(T'', \xi) = \Delta_r H(T', \xi) + \int_{T'}^{T''} \Delta_r C_p(T, \xi) \, dT \quad (11.3.11)$$

This relation is analogous to Eq. 11.3.9, using molar differential reaction quantities in place of integral reaction quantities.

11.4 Enthalpies of Solution and Dilution

The processes of solution (dissolution) and dilution are related. The IUPAC Green Book⁸ recommends the abbreviations sol and dil for these processes.

During a **solution process**, a solute is transferred from a pure solute phase (solid, liquid, or gas) to a solvent or solution phase. During a **dilution process**, solvent is transferred

⁸Ref. [36], Sec. 2.11.1.

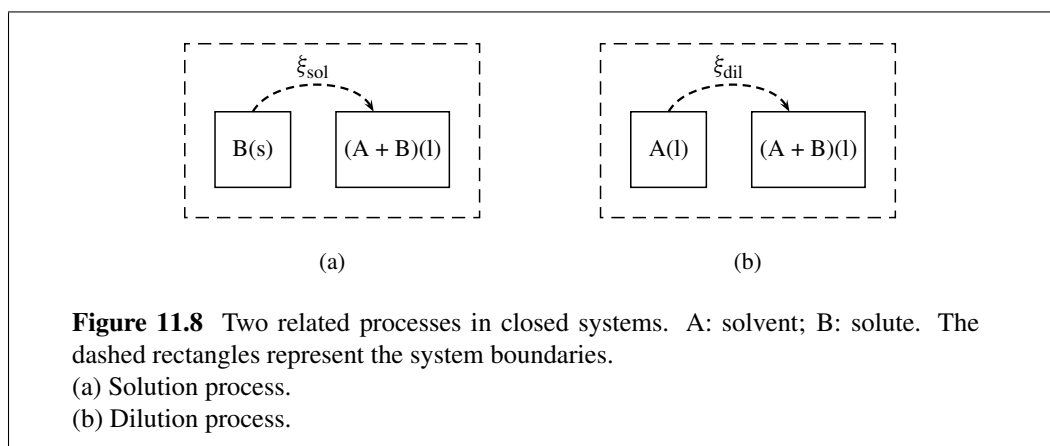

from a pure solvent phase to a solution phase. We may specify the advancement of these two kinds of processes by ξ_{sol} and ξ_{dil} , respectively. Note that both processes take place in *closed* systems that (at least initially) have two phases. The total amounts of solvent and solute in the systems do not change, but the amounts in pure phases diminish as the processes advance and ξ_{sol} or ξ_{dil} increases (Fig. 11.8).

The equations in this section are about enthalpies of solution and dilution, but you can replace H by any other extensive state function to obtain relations for its solution and dilution properties.

11.4.1 Molar enthalpy of solution

First let us consider a solution process in which solute is transferred from a pure solute phase to a solution. The **molar differential enthalpy of solution**, $\Delta_{\text{sol}}H$, is the rate of change of H with the advancement ξ_{sol} at constant T and p , where ξ_{sol} is the amount of solute transferred:

$$\Delta_{\text{sol}}H = \left(\frac{\partial H}{\partial \xi_{\text{sol}}} \right)_{T,p,n_A} \quad (11.4.1)$$

The value of $\Delta_{\text{sol}}H$ at a given T and p depends only on the solution molality and not on the amount of solution.

When we write the solution reaction as $B^* \rightarrow B(\text{sln})$, the general relation $\Delta_r X = \sum_i \nu_i X_i$ (Eq. 11.2.15) becomes

$$\Delta_{\text{sol}}H = H_B - H_B^* \quad (11.4.2)$$

where H_B is the partial molar enthalpy of the solute in the solution and H_B^* is the molar enthalpy of the pure solute at the same T and p .

The **molar enthalpy of solution at infinite dilution**, $\Delta_{\text{sol}}H^\infty$, is the rate of change of H with ξ_{sol} when the solute is transferred to a solution with the thermal properties of an infinitely dilute solution. We can think of $\Delta_{\text{sol}}H^\infty$ as the enthalpy change per amount of solute transferred to a very large volume of pure solvent. According to Eq. 11.4.2, this quantity is given by

$$\Delta_{\text{sol}}H^\infty = H_B^\infty - H_B^* \quad (11.4.3)$$

Note that because the values of H_B^∞ and H_B^* are independent of the solution composition, the molar differential and integral enthalpies of solution at infinite dilution are the same.

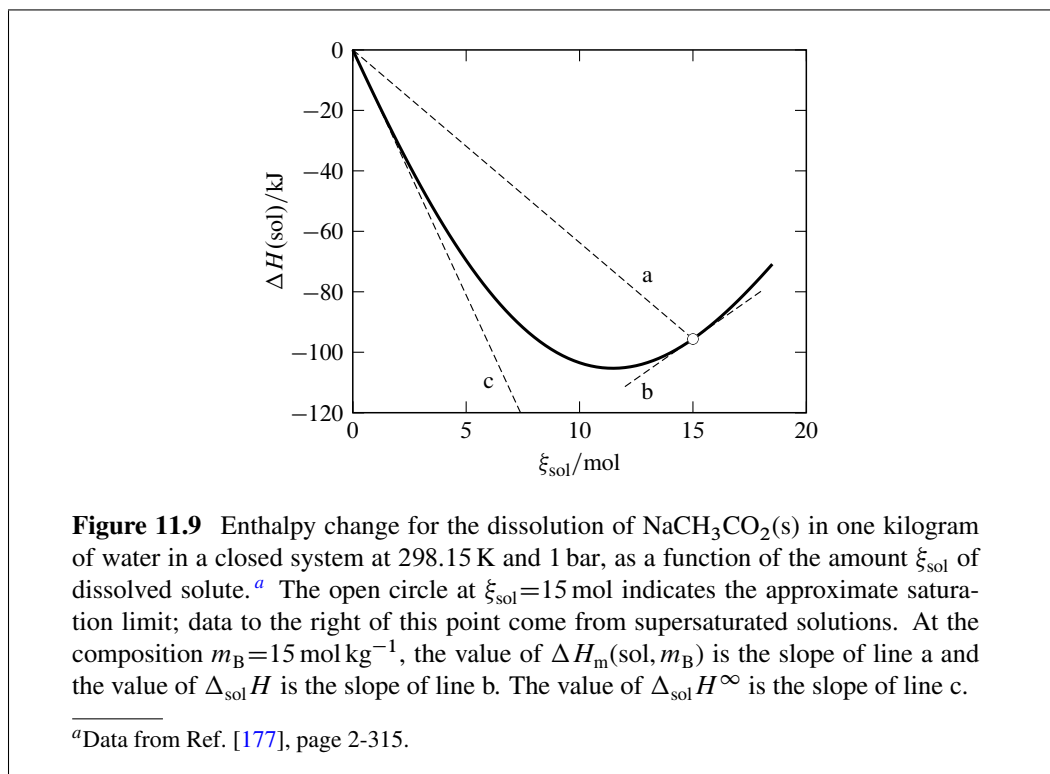

An **integral enthalpy of solution**, $\Delta H(\text{sol})$, is the enthalpy change for a process in which a finite amount ξ_{sol} of solute is transferred from a pure solute phase to a specified amount of pure solvent to form a homogeneous solution phase with the same temperature and pressure as the initial state. Division by the amount transferred gives the **molar integral enthalpy of solution** which this book will denote by $\Delta H_{\text{m}}(\text{sol}, m_{\text{B}})$, where m_{B} is the molality of the solution formed:

$$\Delta H_{\text{m}}(\text{sol}, m_{\text{B}}) = \frac{\Delta H(\text{sol})}{\xi_{\text{sol}}} \quad (11.4.4)$$

An integral enthalpy of solution can be evaluated by carrying out the solution process in a constant-pressure reaction calorimeter, as will be described in Sec. 11.5.1. Experimental values of $\Delta H(\text{sol})$ as a function of ξ_{sol} can be collected by measuring enthalpy changes during a series of successive additions of the solute to a fixed amount of solvent, resulting in a solution whose molality increases in stages. The enthalpy changes are cumulative, so the value of $\Delta H(\text{sol})$ after each addition is the sum of the enthalpy changes for this and the previous additions.

The relations between $\Delta H(\text{sol})$ and the molar integral and differential enthalpies of solution are illustrated in Fig. 11.9 with data for the solution of crystalline sodium acetate in water. The curve shows $\Delta H(\text{sol})$ as a function of ξ_{sol} , with ξ_{sol} defined as the amount of solute dissolved in one kilogram of water. Thus at any point along the curve, the molality is $m_{\text{B}} = \xi_{\text{sol}}/(1 \text{ kg})$ and the ratio $\Delta H(\text{sol})/\xi_{\text{sol}}$ is the molar integral enthalpy of solution $\Delta H_{\text{m}}(\text{sol}, m_{\text{B}})$ for the solution process that produces solution of this molality. The slope of

the curve is the molar differential enthalpy of solution:

$$\Delta_{\text{sol}}H = \frac{d\Delta H(\text{sol})}{d\xi_{\text{sol}}} \quad (11.4.5)$$

(constant T , p , and n_A)

The slope of the curve at $\xi_{\text{sol}}=0$ is $\Delta_{\text{sol}}H^\infty$, the molar enthalpy of solution at infinite dilution. If the measurements are made at the standard pressure, $\Delta_{\text{sol}}H^\infty$ is the same as the standard molar enthalpy of solution, $\Delta_{\text{sol}}H^\circ$, because the standard molar enthalpy of a solute is the molar enthalpy at $p=p^\circ$ and infinite dilution.

11.4.2 Enthalpy of dilution

Next let us consider a dilution process in which solvent is transferred from a pure solvent phase to a solution phase. The **molar differential enthalpy of dilution** is the rate of change of H with the advancement ξ_{dil} at constant T and p of the dilution process, where ξ_{dil} is the amount of solvent transferred:

$$\Delta_{\text{dil}}H = \left(\frac{\partial H}{\partial \xi_{\text{dil}}} \right)_{T,p,n_B} \quad (11.4.6)$$

For the dilution reaction $A^* \rightarrow A(\text{soln})$, the general relation $\Delta_r X = \sum_i \nu_i X_i$ becomes

$$\Delta_{\text{dil}}H = H_A - H_A^* \quad (11.4.7)$$

where H_A is the partial molar enthalpy of the solvent in the solution. In the limit of infinite dilution, H_A must approach the molar enthalpy of pure solvent, H_A^* ; then Eq. 11.4.7 shows that $\Delta_{\text{dil}}H$ approaches zero in this limit.

An **integral enthalpy of dilution**, $\Delta H(\text{dil})$, refers to the enthalpy change for transfer of a finite amount of solvent from a pure solvent phase to a solution, T and p being the same before and after the process. The **molar integral enthalpy of dilution** is the ratio of $\Delta H(\text{dil})$ and the amount of solute in the solution. For a dilution process at constant solute amount n_B in which the molality changes from m'_B to m''_B , this book will use the notation $\Delta H_m(\text{dil}, m'_B \rightarrow m''_B)$:

$$\Delta H_m(\text{dil}, m'_B \rightarrow m''_B) = \frac{\Delta H(\text{dil})}{n_B} \quad (11.4.8)$$

The value of $\Delta H_m(\text{dil}, m'_B \rightarrow m''_B)$ at a given T and p depends only on the initial and final molalities m'_B and m''_B .

There is a simple relation between molar integral enthalpies of solution and dilution, as the following derivation demonstrates. Consider the following two ways of preparing a solution of molality m''_B from pure solvent and solute phases. Both paths are at constant T and p in a closed system.

Path 1: The solution forms directly by dissolution of the solute in the solvent. The enthalpy change is $n_B \Delta H_m(\text{sol}, m''_B)$, where the molality of the solution is indicated in parentheses.

Path 2: Starting with the unmixed solvent and solute, the solute dissolves in a portion of the solvent to form a solution of composition m'_B (more concentrated than m''_B). The enthalpy change is $n_B \Delta H_m(\text{sol}, m'_B)$. In a second step of this path, the remaining pure solvent mixes with the solution to dilute it from m'_B to m''_B . The enthalpy change of the second step is $n_B \Delta H_m(\text{dil}, m'_B \rightarrow m''_B)$.

Since both paths have the same initial states and the same final states, both have the same overall enthalpy change:

$$n_B \Delta H_m(\text{sol}, m_B'') = n_B \Delta H_m(\text{sol}, m_B') + n_B \Delta H_m(\text{dil}, m_B' \rightarrow m_B'') \quad (11.4.9)$$

or

$$\Delta H_m(\text{sol}, m_B'') = \Delta H_m(\text{sol}, m_B') + \Delta H_m(\text{dil}, m_B' \rightarrow m_B'') \quad (11.4.10)$$

Equation 11.4.10 is the desired relation. It shows how a measurement of the molar integral enthalpy change for a solution process that produces solution of a certain molality can be combined with dilution measurements in order to calculate molar integral enthalpies of solution for more dilute solutions. Experimentally, it is sometimes more convenient to carry out the dilution process than the solution process, especially when the pure solute is a gas or solid.

11.4.3 Molar enthalpies of solute formation

Molar integral enthalpies of solution and dilution are conveniently expressed in terms of molar enthalpies of formation. The molar enthalpy of formation of a solute in solution is the enthalpy change per amount of solute for a process at constant T and p in which the solute, in a solution of a given molality, is formed from its constituent elements in their reference states. The molar enthalpy of formation of solute B in solution of molality m_B will be denoted by $\Delta_f H(\text{B}, m_B)$.

As explained in Sec. 11.3.2, the formation reaction of a solute in solution does not include the formation of the solvent from its elements. For example, the formation reaction for NaOH in an aqueous solution that has 50 moles of water for each mole of NaOH is

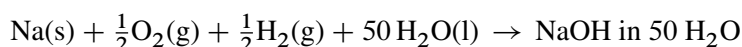

Consider a solution process at constant T and p in which an amount n_B of pure solute (solid, liquid, or gas) is mixed with an amount n_A of pure solvent, resulting in solution of molality m_B . We may equate the enthalpy change of this process to the sum of the enthalpy changes for the following two hypothetical steps:

1. An amount n_B of the pure solute decomposes to the constituent elements in their reference states. This is the reverse of the formation reaction of the pure solute.
2. The solution is formed from these elements and an amount n_A of the solvent.

The total enthalpy change is then $\Delta H(\text{sol}) = -n_B \Delta_f H(\text{B}^*) + n_B \Delta_f H(\text{B}, m_B)$. Dividing by n_B , we obtain the molar integral enthalpy of solution:

$$\Delta H_m(\text{sol}, m_B) = \Delta_f H(\text{B}, m_B) - \Delta_f H(\text{B}^*) \quad (11.4.11)$$

By combining Eqs. 11.4.10 and 11.4.11, we obtain the following expression for a molar integral enthalpy of dilution in terms of molar enthalpies of formation:

$$\Delta H_m(\text{dil}, m_B' \rightarrow m_B'') = \Delta_f H(\text{B}, m_B'') - \Delta_f H(\text{B}, m_B') \quad (11.4.12)$$

From tabulated values of molar enthalpies of formation, we can calculate molar integral enthalpies of solution with Eq. 11.4.11 and molar integral enthalpies of dilution with Eq. 11.4.12. Conversely, calorimetric measurements of these molar integral enthalpies can be combined with the value of $\Delta_f H(\text{B}^*)$ to establish the values of molar enthalpies of solute formation in solutions of various molalities.

11.4.4 Evaluation of relative partial molar enthalpies

Although it is not possible to determine absolute values of partial molar enthalpies, we can evaluate H_A and H_B relative to appropriate solvent and solute reference states.

The **relative partial molar enthalpy of the solvent** is defined by

$$L_A \stackrel{\text{def}}{=} H_A - H_A^* \quad (11.4.13)$$

This is the partial molar enthalpy of the solvent in a solution of given composition relative to pure solvent at the same temperature and pressure.

L_A can be related to molar differential and integral enthalpies of solution as follows. The enthalpy change to form a solution from amounts n_A and n_B of pure solvent and solute is given, from the additivity rule, by $\Delta H(\text{sol}) = (n_A H_A + n_B H_B) - (n_A H_A^* + n_B H_B^*)$. We rearrange and make substitutions from Eqs. 11.4.2 and 11.4.13:

$$\begin{aligned} \Delta H(\text{sol}) &= n_A(H_A - H_A^*) + n_B(H_B - H_B^*) \\ &= n_A L_A + n_B \Delta_{\text{sol}} H \end{aligned} \quad (11.4.14)$$

$\Delta H(\text{sol})$ is also given, from Eq. 11.4.4, by

$$\Delta H(\text{sol}) = n_B \Delta H_{\text{m}}(\text{sol}, m_B) \quad (11.4.15)$$

Equating both expressions for $\Delta H(\text{sol})$, solving for L_A , and replacing n_B/n_A by $M_A m_B$, we obtain

$$L_A = M_A m_B [\Delta H_{\text{m}}(\text{sol}, m_B) - \Delta_{\text{sol}} H] \quad (11.4.16)$$

Thus L_A depends on the difference between the molar integral and differential enthalpies of solution.

The **relative partial molar enthalpy of a solute** is defined by

$$L_B \stackrel{\text{def}}{=} H_B - H_B^\infty \quad (11.4.17)$$

The reference state for the solute is the solute at infinite dilution. To relate L_B to molar enthalpies of solution, we write the identity

$$L_B = H_B - H_B^\infty = (H_B - H_B^*) - (H_B^\infty - H_B^*) \quad (11.4.18)$$

From Eqs. 11.4.2 and 11.4.3, this becomes

$$L_B = \Delta_{\text{sol}} H - \Delta_{\text{sol}} H^\infty \quad (11.4.19)$$

We see that L_B is equal to the difference between the molar differential enthalpies of solution at the molality of interest and at infinite dilution.

For a solution of a given molality, L_A and L_B can be evaluated from calorimetric measurements of $\Delta H(\text{sol})$ by various methods. Three general methods are as follows.⁹

⁹The descriptions refer to graphical plots with smoothed curves drawn through experimental points. A plot can be replaced by an algebraic function (e.g., a power series) fitted to the points, and slopes and intercepts can then be evaluated by numerical methods.

- L_A and L_B can be evaluated by the variant of the method of intercepts described on page 234. The molar integral enthalpy of mixing, $\Delta H_m(\text{mix}) = \Delta H(\text{sol})/(n_A + n_B)$, is plotted versus x_B . The tangent to the curve at a given value of x_B has intercepts L_A at $x_B=0$ and $H_B - H_B^* = \Delta_{\text{sol}}H$ at $x_B=1$, where the values of L_A and $\Delta_{\text{sol}}H$ are for the solution of composition x_B . The tangent to the curve at $x_B=0$ has intercept $\Delta_{\text{sol}}H^\infty$ at $x_B=1$. L_B is equal to the difference of these values of $\Delta_{\text{sol}}H$ and $\Delta_{\text{sol}}H^\infty$ (Eq. 11.4.19).
- Values of $\Delta H(\text{sol})$ for a constant amount of solvent can be plotted as a function of ξ_{sol} , as in Fig. 11.9. The slope of the tangent to the curve at any point on the curve is equal to $\Delta_{\text{sol}}H$ for the molality m_B at that point, and the initial slope at $\xi_{\text{sol}}=0$ is equal to $\Delta_{\text{sol}}H^\infty$. L_B at molality m_B is equal to the difference of these two values, and L_A can be calculated from Eq. 11.4.16.
- A third method for the evaluation of L_A and L_B is especially useful for solutions of an electrolyte solute. This method takes advantage of the fact that a plot of $\Delta H_m(\text{sol}, m_B)$ versus $\sqrt{m_B}$ has a finite limiting slope at $\sqrt{m_B}=0$ whose value for an electrolyte can be predicted from the Debye–Hückel limiting law, providing a useful guide for the extrapolation of $\Delta H_m(\text{sol}, m_B)$ to its limiting value $\Delta_{\text{sol}}H^\infty$. The remainder of this section describes this third method.

The third method assumes we measure the integral enthalpy of solution $\Delta H(\text{sol})$ for varying amounts ξ_{sol} of solute transferred at constant T and p from a pure solute phase to a fixed amount of solvent. From Eq. 11.4.5, the molar differential enthalpy of solution is given by $\Delta_{\text{sol}}H = d\Delta H(\text{sol})/d\xi_{\text{sol}}$ when n_A is held constant. We make the substitution $\Delta H(\text{sol}) = \xi_{\text{sol}}\Delta H_m(\text{sol}, m_B)$ and take the derivative of the expression with respect to ξ_{sol} :

$$\begin{aligned}\Delta_{\text{sol}}H &= \frac{d[\xi_{\text{sol}}\Delta H_m(\text{sol}, m_B)]}{d\xi_{\text{sol}}} \\ &= \Delta H_m(\text{sol}, m_B) + \xi_{\text{sol}} \frac{d\Delta H_m(\text{sol}, m_B)}{d\xi_{\text{sol}}}\end{aligned}\quad (11.4.20)$$

At constant n_A , m_B is proportional to ξ_{sol} , so that $d\xi_{\text{sol}}/\xi_{\text{sol}}$ can be replaced by dm_B/m_B . When we combine the resulting expression for $\Delta_{\text{sol}}H$ with Eq. 11.4.19, we get the following expression for the relative partial molar enthalpy of the solute:

$$L_B = \Delta H_m(\text{sol}, m_B) + m_B \frac{d\Delta H_m(\text{sol}, m_B)}{dm_B} - \Delta_{\text{sol}}H^\infty \quad (11.4.21)$$

It is convenient to define the quantity

$$\Phi_L \stackrel{\text{def}}{=} \Delta H_m(\text{sol}, m_B) - \Delta_{\text{sol}}H^\infty \quad (11.4.22)$$

known as the *relative apparent molar enthalpy of the solute*. Because $\Delta_{\text{sol}}H^\infty$ is independent of m_B , the derivative $d\Phi_L/dm_B$ is equal to $d\Delta H_m(\text{sol}, m_B)/dm_B$. We can therefore write Eq. 11.4.21 in the compact form

$$L_B = \Phi_L + m_B \frac{d\Phi_L}{dm_B} \quad (11.4.23)$$

(constant T and p)

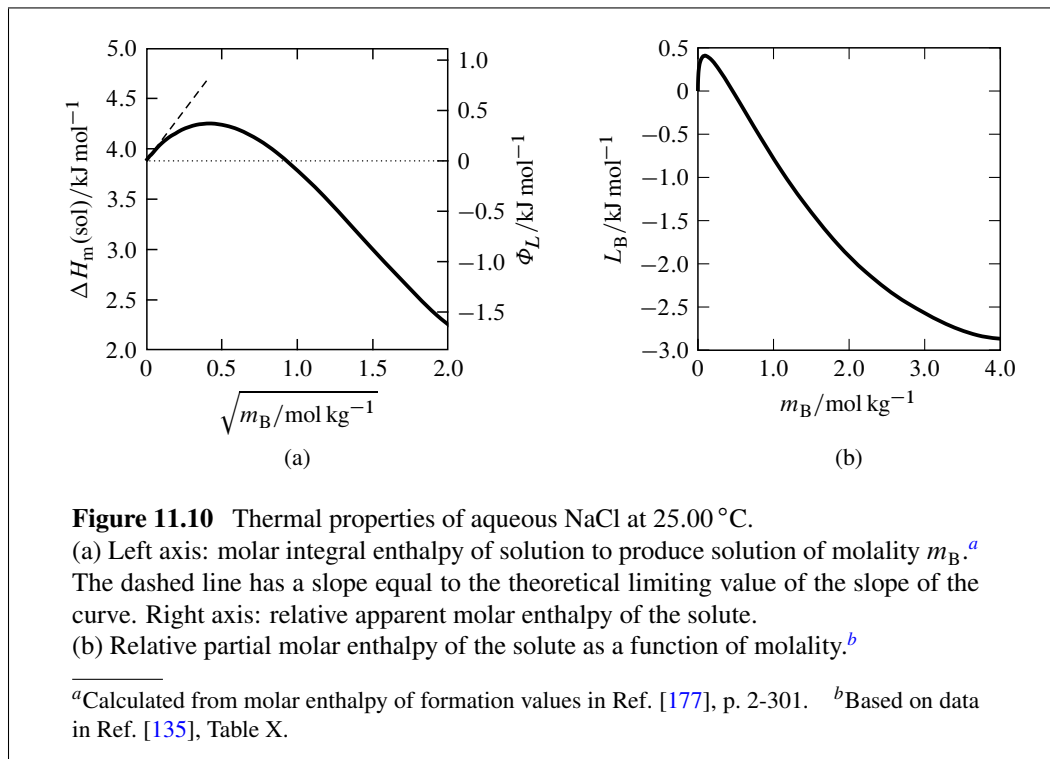

Equation 11.4.23 allows us to evaluate L_B at any molality from the dependence of Φ_L on m_B , with Φ_L obtained from experimental molar integral enthalpies of solution according to Eq. 11.4.22.

Once Φ_L and L_B have been evaluated for a given molality, it is a simple matter to calculate L_A at that molality. By combining Eqs. 11.4.16 and 11.4.22, we obtain the relation

$$L_A = M_A m_B (\Phi_L - L_B) \quad (11.4.24)$$

For an electrolyte solute, a plot of $\Delta H_m(\text{sol}, m_B)$ versus m_B has a limiting slope of $+\infty$ at $m_B=0$, whereas the limiting slope of $\Delta H_m(\text{sol}, m_B)$ versus $\sqrt{m_B}$ is finite and can be predicted from the Debye–Hückel limiting law. Accordingly, a satisfactory procedure is to plot $\Delta H_m(\text{sol}, m_B)$ versus $\sqrt{m_B}$, perform a linear extrapolation of the experimental points to $\sqrt{m_B}=0$, and then shift the origin to the extrapolated intercept. The result is a plot of Φ_L versus $\sqrt{m_B}$. An example for aqueous NaCl solutions is shown in Fig. 11.10(a).

We can also evaluate Φ_L from experimental enthalpies of dilution. From Eqs. 11.4.10 and 11.4.22, we obtain the relation

$$\Phi_L(m_B'') - \Phi_L(m_B') = \Delta H_m(\text{dil}, m_B' \rightarrow m_B'') \quad (11.4.25)$$

We can measure the enthalpy changes for diluting a solution of initial molality m_B' to various molalities m_B'' , plot the values of $\Delta H_m(\text{dil}, m_B' \rightarrow m_B'')$ versus $\sqrt{m_B}$, extrapolate the curve to $\sqrt{m_B}=0$, and shift the origin to the extrapolated intercept, resulting in a plot of Φ_L versus $\sqrt{m_B}$.

In order to be able to use Eq. 11.4.23, we need to relate the derivative $d\Phi_L/dm_B$ to the slope of the curve of Φ_L versus $\sqrt{m_B}$. We write

$$d\sqrt{m_B} = \frac{1}{2\sqrt{m_B}} dm_B \quad dm_B = 2\sqrt{m_B} d\sqrt{m_B} \quad (11.4.26)$$

Substituting this expression for dm_B into Eq. 11.4.23, we obtain the following operational equation for evaluating L_B from the plot of Φ_L versus $\sqrt{m_B}$:

$$L_B = \Phi_L + \frac{\sqrt{m_B}}{2} \frac{d\Phi_L}{d\sqrt{m_B}} \quad (11.4.27)$$

(constant T and p)

The value of Φ_L goes to zero at infinite dilution. When the solute is an electrolyte, the dependence of Φ_L on m_B in solutions dilute enough for the Debye–Hückel limiting law to apply is given by

$$\Phi_L = C_{\Phi_L} \sqrt{m_B} \quad (11.4.28)$$

(very dilute solution)

For aqueous solutions of a 1:1 electrolyte at 25 °C, the coefficient C_{Φ_L} has the value¹⁰

$$C_{\Phi_L} = 1.988 \times 10^3 \text{ J kg}^{1/2} \text{ mol}^{-3/2} \quad (11.4.29)$$

C_{Φ_L} is equal to the limiting slope of Φ_L versus $\sqrt{m_B}$, of $\Delta H_m(\text{sol}, m_B)$ versus $\sqrt{m_B}$, and of $\Delta H_m(\text{dil}, m'_B \rightarrow m''_B)$ versus $\sqrt{m'_B}$. The value given by Eq. 11.4.29 can be used for extrapolation of measurements at 25 °C and low molality to infinite dilution.

Equation 11.4.28 can be derived as follows. For simplicity, we assume the pressure is the standard pressure p° . At this pressure H_B^∞ is the same as H_B° , and Eq. 11.4.17 becomes $L_B = H_B - H_B^\circ$. From Eqs. 12.1.3 and 12.1.6 in the next chapter, we can write the relations

$$H_B = -T^2 \left[\frac{\partial(\mu_B/T)}{\partial T} \right]_{p, \{n_i\}} \quad H_B^\circ = -T^2 \frac{d(\mu_{m,B}^\circ/T)}{dT} \quad (11.4.30)$$

Subtracting the second of these relations from the first, we obtain

$$H_B - H_B^\circ = -T^2 \left[\frac{\partial(\mu_B - \mu_{m,B}^\circ)/T}{\partial T} \right]_{p, \{n_i\}} \quad (11.4.31)$$

The solute activity on a molality basis, $a_{m,B}$, is defined by $\mu_B - \mu_{m,B}^\circ = RT \ln a_{m,B}$. The activity of an electrolyte solute at the standard pressure, from Eq. 10.3.10, is given by $a_{m,B} = (v_+^{v_+} v_-^{v_-}) \gamma_\pm^v (m_B/m^\circ)^v$. Accordingly, the relative partial molar enthalpy of the solute is related to the mean ionic activity coefficient by

$$L_B = -RT^2 v \left(\frac{\partial \ln \gamma_\pm}{\partial T} \right)_{p, \{n_i\}} \quad (11.4.32)$$

We assume the solution is sufficiently dilute for the mean ionic activity coefficient to be adequately described by the Debye–Hückel limiting law, Eq. 10.4.8: In $\gamma_\pm =$

¹⁰The fact that C_{Φ_L} is positive means, according to Eq. 11.4.25, that dilution of a very dilute electrolyte solution is an exothermic process.

$-A_{\text{DH}} |z_+ z_-| \sqrt{I_m}$, where A_{DH} is a temperature-dependent quantity defined on page 297. Then Eq. 11.4.32 becomes

$$L_B = RT^2 v |z_+ z_-| \sqrt{I_m} \left(\frac{\partial A_{\text{DH}}}{\partial T} \right)_{p, \{n_i\}} \quad (11.4.33)$$

(very dilute solution)

Substitution of the expression given by Eq. 10.4.9 on page 299 for I_m in a solution of a single completely-dissociated electrolyte converts Eq. 11.4.33 to

$$L_B = \left[\frac{RT^2}{\sqrt{2}} \left(\frac{\partial \rho_A^* A_{\text{DH}}}{\partial T} \right)_{p, \{n_i\}} (v |z_+ z_-|)^{3/2} \right] \sqrt{m_B}$$

$$= C_{L_B} \sqrt{m_B} \quad (11.4.34)$$

(very dilute solution)

The coefficient C_{L_B} (the quantity in brackets) depends on T , the kind of solvent, and the ion charges and number of ions per solute formula unit, but not on the solute molality.

Let C_{Φ_L} represent the limiting slope of Φ_L versus $\sqrt{m_B}$. In a very dilute solution we have $\Phi_L = C_{\Phi_L} \sqrt{m_B}$, and Eq. 11.4.27 becomes

$$L_B = \Phi_L + \frac{\sqrt{m_B}}{2} \frac{d\Phi_L}{d\sqrt{m_B}} = C_{\Phi_L} \sqrt{m_B} + \frac{\sqrt{m_B}}{2} C_{\Phi_L} \quad (11.4.35)$$

By equating this expression for L_B with the one given by Eq. 11.4.34 and solving for C_{Φ_L} , we obtain $C_{\Phi_L} = (2/3)C_{L_B}$ and $\Phi_L = (2/3)C_{L_B} \sqrt{m_B}$.

11.5 Reaction Calorimetry

Reaction calorimetry is used to evaluate the molar integral reaction enthalpy $\Delta H_m(\text{rxn})$ of a reaction or other chemical process at constant temperature and pressure. The measurement actually made, however, is a temperature change.

Sections 11.5.1 and 11.5.2 will describe two common types of calorimeters designed for reactions taking place at either constant pressure or constant volume. The constant-pressure type is usually called a *reaction calorimeter*, and the constant-volume type is known as a *bomb calorimeter* or *combustion calorimeter*.

In either type of calorimeter, the chemical process takes place in a reaction vessel surrounded by an outer jacket. The jacket may be of either the adiabatic type or the isothermal-jacket type described in Sec. 7.3.2 in connection with heat capacity measurements. A temperature-measuring device is immersed either in the vessel or in a phase in thermal contact with it. The measured temperature change is caused by the chemical process, instead of by electrical work as in the determination of heat capacity. One important way in which these calorimeters differ from ones used for heat capacity measurements is that work is kept deliberately small, in order to minimize changes of internal energy and enthalpy during the experimental process.

11.5.1 The constant-pressure reaction calorimeter

The contents of a constant-pressure calorimeter are usually open to the atmosphere, so this type of calorimeter is unsuitable for processes involving gases. It is, however, a convenient

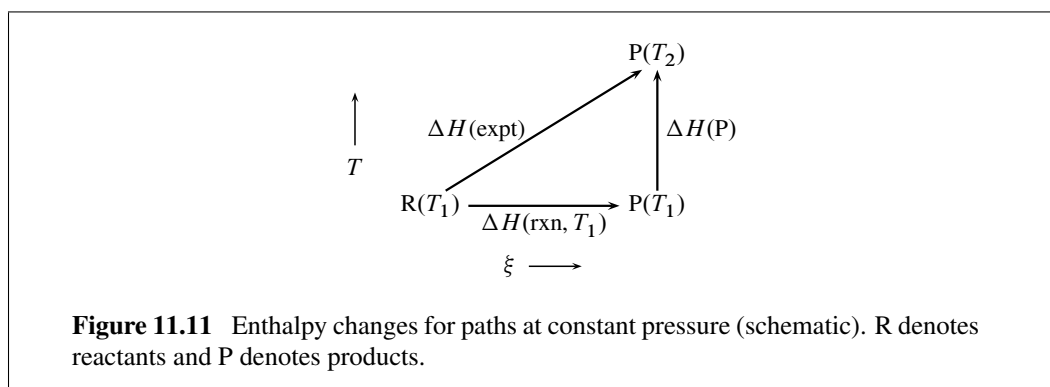

apparatus in which to study a liquid-phase chemical reaction, the dissolution of a solid or liquid solute in a liquid solvent, or the dilution of a solution with solvent.

The process is initiated in the calorimeter by allowing the reactants to come into contact. The temperature in the reaction vessel is measured over a period of time starting before the process initiation and ending after the advancement has reached a final value with no further change.

The heating or cooling curve (temperature as a function of time) is observed over a period of time that includes the period during which the advancement ξ changes. For an exothermic reaction occurring in an adiabatic calorimeter, the heating curve may resemble that shown in Fig. 7.3 on page 172, and the heating curve in an isothermal-jacket calorimeter may resemble that shown in Fig. 7.4 on page 174. Two points are designated on the heating or cooling curve: one at temperature T_1 , before the reaction is initiated, and the other at T_2 , after ξ has reached its final value. These points are indicated by open circles in Figs. 7.3 and 7.4.

Figure 11.11 depicts three paths at constant pressure. The enthalpy change of the experimental process, in which reactants at temperature T_1 change to products at temperature T_2 , is denoted $\Delta H(\text{expt})$.

The value of $\Delta H(\text{expt})$ at constant pressure would be zero if the process were perfectly adiabatic and the only work were expansion work, but this is rarely the case. There may be unavoidable work from stirring and from electrical temperature measurement. We can evaluate $\Delta H(\text{expt})$ by one of the methods described in Sec. 7.3.2. For an adiabatic calorimeter, the appropriate expression is $\Delta H(\text{expt}) = \epsilon r(t_2 - t_1)$ (Eq. 7.3.19 on page 173 with w_{el} set equal to zero), where ϵ is the energy equivalent of the calorimeter, r is the slope of the heating curve when no reaction is occurring, and t_1 and t_2 are the times at temperatures T_1 and T_2 . For an isothermal-jacket calorimeter, we evaluate $\Delta H(\text{expt})$ using Eq. 7.3.28 on page 175 with w_{el} set equal to zero.

The enthalpy change we wish to find is the reaction enthalpy $\Delta H(\text{rxn}, T_1)$, which is the change for the same advancement of the reaction at *constant* temperature T_1 . The paths labeled $\Delta H(\text{expt})$ and $\Delta H(\text{rxn}, T_1)$ in the figure have the same initial state and different final states. The path connecting these two final states is for a change of the temperature from T_1 to T_2 with ξ fixed at its final value; the enthalpy change for this path is denoted

$\Delta H(\text{P})$.¹¹ The value of $\Delta H(\text{P})$ can be calculated from

$$\Delta H(\text{P}) = \epsilon_{\text{p}}(T_2 - T_1) \quad (11.5.1)$$

where ϵ_{p} is the energy equivalent (the average heat capacity of the calorimeter) when the calorimeter contains the products. To measure ϵ_{p} , we can carry out a second experiment involving work with an electric heater included in the calorimeter, similar to the methods described in Sec. 7.3.2.

Since the difference of enthalpy between two states is independent of the path, we can write $\Delta H(\text{expt}) = \Delta H(\text{rxn}, T_1) + \epsilon_{\text{p}}(T_2 - T_1)$, or

$$\Delta H(\text{rxn}, T_1) = -\epsilon_{\text{p}}(T_2 - T_1) + \Delta H(\text{expt}) \quad (11.5.2)$$

The molar integral reaction enthalpy at temperature T_1 is the reaction enthalpy divided by $\Delta\xi$, the advancement during the experimental process:

$$\begin{aligned} \Delta H_{\text{m}}(\text{rxn}) &= \Delta H(\text{rxn}, T_1) / \Delta\xi \\ &= \frac{-\epsilon_{\text{p}}(T_2 - T_1) + \Delta H(\text{expt})}{\Delta\xi} \end{aligned} \quad (11.5.3)$$

(constant-pressure calorimeter)

Note that $\Delta H(\text{expt})$ is small, so that $\Delta H_{\text{m}}(\text{rxn})$ is approximately equal to $-\epsilon_{\text{p}}(T_2 - T_1) / \Delta\xi$. If T_2 is greater than T_1 (the process is exothermic), then $\Delta H_{\text{m}}(\text{rxn})$ is *negative*, reflecting the fact that after the reaction takes place in the calorimeter, heat would have to leave the system in order for the temperature to return to its initial value. If T_2 is less than T_1 (the process is endothermic), $\Delta H_{\text{m}}(\text{rxn})$ is *positive*.

Most reactions cause a change in the composition of one or more phases, in which case $\Delta H_{\text{m}}(\text{rxn})$ is not the same as the molar differential reaction enthalpy, $\Delta_{\text{r}}H = (\partial H / \partial \xi)_{T,p}$, unless the phase or phases can be treated as ideal mixtures (see Sec. 11.2.2). Corrections, usually small, are needed to obtain the standard molar reaction enthalpy $\Delta_{\text{r}}H^{\circ}$ from $\Delta H_{\text{m}}(\text{rxn})$.

11.5.2 The bomb calorimeter

A bomb calorimeter typically is used to carry out the complete combustion of a solid or liquid substance in the presence of excess oxygen. The combustion reaction is initiated with electrical ignition. In addition to the main combustion reaction, there may be unavoidable side reactions, such as the formation of nitrogen oxides if N_2 is not purged from the gas phase. Sometimes auxiliary reactions are deliberately carried out to complete or moderate the main reaction.

From the measured heating curve and known properties of the calorimeter, reactants, and products, it is possible to evaluate the standard molar enthalpy of combustion, $\Delta_{\text{c}}H^{\circ}$, of the substance of interest at a particular temperature called the reference temperature, T_{ref} . (T_{ref} is often chosen to be 298.15 K, which is 25.00 °C.) With careful work, using temperature measurements with a resolution of 1×10^{-4} K or better and detailed corrections, the precision of $\Delta_{\text{c}}H^{\circ}$ can be of the order of 0.01 percent.

¹¹The symbol P refers to the final equilibrium state in which the reaction vessel contains products of the reaction and any excess reactants.

Bomb calorimetry is the principal means by which standard molar enthalpies of combustion of individual elements and of compounds of these elements are evaluated. From these values, using Hess's law, we can calculate the standard molar enthalpies of *formation* of the compounds as described in Sec. 11.3.2. From the formation values of only a few compounds, the standard molar reaction enthalpies of innumerable reactions can be calculated with Hess's law (Eq. 11.3.3 on page 322).

Because of their importance, the experimental procedure and the analysis of the data it provides will now be described in some detail. A comprehensive problem (Prob. 11.7) based on this material is included at the end of the chapter.

There are five main steps in the procedure of evaluating a standard molar enthalpy of combustion:

1. The combustion reaction, and any side reactions and auxiliary reactions, are carried out in the calorimeter, and the course of the resulting temperature change is observed.
2. The experimental data are used to determine the value of $\Delta U(\text{IBP}, T_2)$, the internal energy change of the isothermal bomb process at the final temperature of the reaction. The **isothermal bomb process** is the idealized process that would have occurred if the reaction or reactions had taken place in the calorimeter at constant temperature.
3. The internal energy change of the isothermal bomb process is corrected to yield $\Delta U(\text{IBP}, T_{\text{ref}})$, the value at the reference temperature of interest.
4. The standard molar internal energy of combustion, $\Delta_c U^\circ(T_{\text{ref}})$, is calculated. This calculation is called **reduction to standard states**.
5. The standard molar enthalpy of combustion, $\Delta_c H^\circ(T_{\text{ref}})$, is calculated.

These five steps are described below.

Experimental

The common form of combustion bomb calorimeter shown in Fig. 11.12 on the next page consists of a thick-walled cylindrical metal vessel to contain the reactants of the combustion reaction. It is called a "bomb" because it is designed to withstand high pressure. The bomb can be sealed with a gas-tight screw cap. During the reaction, the sealed bomb vessel is immersed in water in the calorimeter, which is surrounded by a jacket. Conceptually, we take the *system* to be everything inside the jacket, including the calorimeter walls, water, bomb vessel, and contents of the bomb vessel.

To prepare the calorimeter for a combustion experiment, a weighed sample of the substance to be combusted is placed in a metal sample holder. The calculations are simplified if we can assume all of the sample is initially in a single phase. Thus, a volatile liquid is usually encapsulated in a bulb of thin glass (which shatters during the ignition) or confined in the sample holder by cellulose tape of known combustion properties. If one of the combustion products is H_2O , a small known mass of liquid water is placed in the bottom of the bomb vessel to saturate the gas space of the bomb vessel with H_2O . The sample holder and ignition wires are lowered into the bomb vessel, the cap is screwed on, and oxygen gas is admitted through a valve in the cap to a total pressure of about 30 bar.

To complete the setup, the sealed bomb vessel is immersed in a known mass of water in the calorimeter. A precision thermometer and a stirrer are also immersed in the water. With the stirrer turned on, the temperature is monitored until it is found to change at a slow,

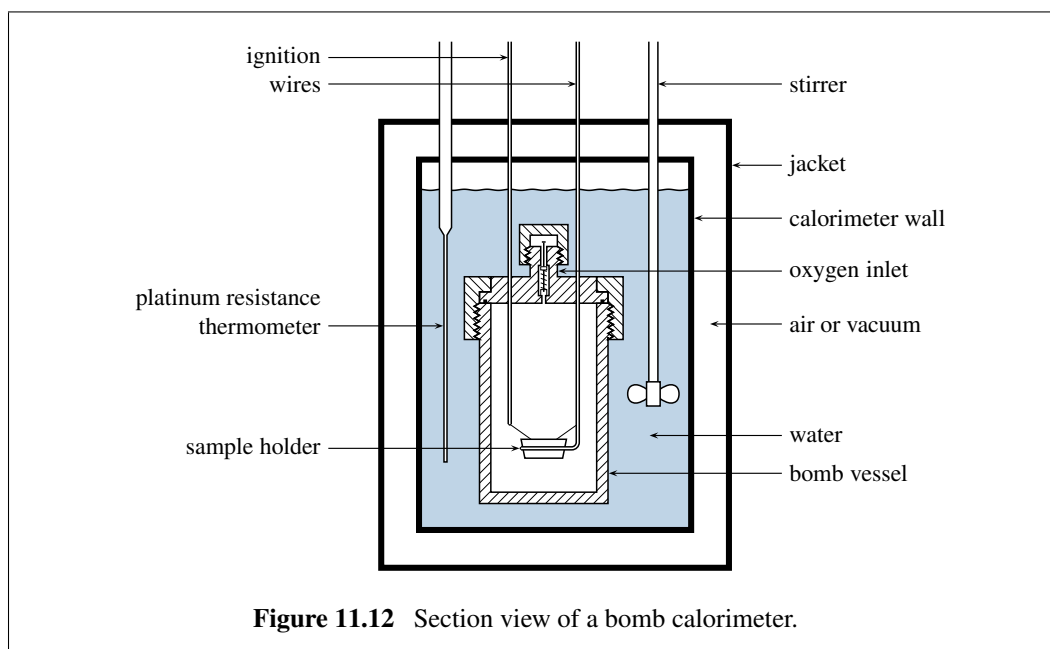

practically-constant rate. This drift is due to heat transfer through the jacket, mechanical stirring work, and the electrical work needed to measure the temperature. A particular time is chosen as the initial time t_1 . The measured temperature at this time is T_1 , assumed to be practically uniform throughout the system.

At or soon after time t_1 , the ignition circuit is closed to initiate the combustion reaction in the bomb vessel. If the reaction is exothermic, the measured temperature rapidly increases over the course of several minutes. For a while the temperature in the system is far from uniform, as energy is transferred by heat through the walls of the bomb vessel walls to the water outside.

When the measured temperature is again observed to change at a slow and practically constant rate, the reaction is assumed to be complete and the temperature is assumed once more to be uniform. A second time is now designated as the final time t_2 , with final temperature T_2 . For best accuracy, conditions are arranged so that T_2 is close to the desired reference temperature T_{ref} .

Because the jacket is not gas tight, the pressure of the water outside the bomb vessel stays constant at the pressure of the atmosphere. Inside the bomb vessel, the changes in temperature and composition take place at essentially constant volume, so the pressure inside the vessel is *not* constant. The volume change of the entire system during the process is negligible.

The isothermal bomb process

The relations derived here parallel those of Sec. 11.5.1 for a constant-pressure calorimeter. The three paths depicted in Fig. 11.13 on the next page are similar to those in Fig. 11.11 on page 335, except that instead of being at constant pressure they are at constant volume. We shall assume the combustion reaction is exothermic, with T_2 being greater than T_1 .

The internal energy change of the experimental process that actually occurs in the calorimeter between times t_1 and t_2 is denoted $\Delta U(\text{expt})$ in the figure. Conceptually, the

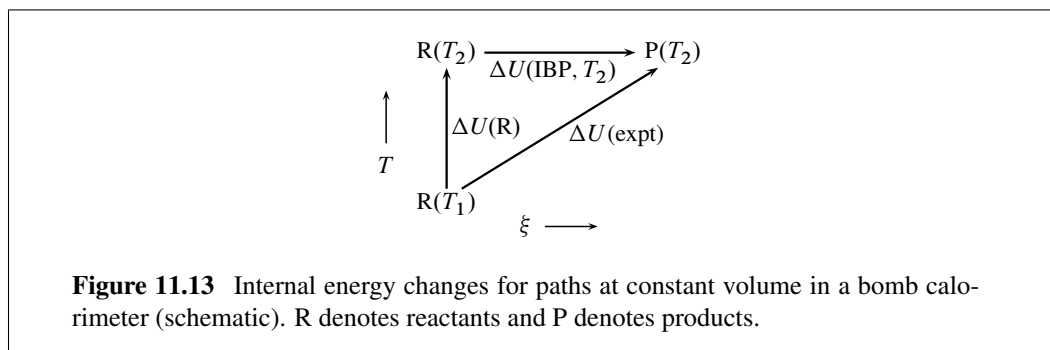

Figure 11.13 Internal energy changes for paths at constant volume in a bomb calorimeter (schematic). R denotes reactants and P denotes products.

overall change of state during this process would be duplicated by a path in which the temperature of the system with the reactants present increases from T_1 to T_2 ,¹² followed by the isothermal bomb process at temperature T_2 . In the figure these paths are labeled with the internal energy changes $\Delta U(\text{R})$ and $\Delta U(\text{IBP}, T_2)$, and we can write

$$\Delta U(\text{expt}) = \Delta U(\text{R}) + \Delta U(\text{IBP}, T_2) \quad (11.5.4)$$

To evaluate $\Delta U(\text{R})$, we can use the energy equivalent ϵ_{R} of the calorimeter with reactants present in the bomb vessel. ϵ_{R} is the average heat capacity of the system between T_1 and T_2 —that is, the ratio $q/(T_2 - T_1)$, where q is the heat that would be needed to change the temperature from T_1 to T_2 . From the first law, with expansion work assumed negligible, the internal energy change equals this heat, giving us the relation

$$\Delta U(\text{R}) = \epsilon_{\text{R}}(T_2 - T_1) \quad (11.5.5)$$

The initial and final states of the path are assumed to be equilibrium states, and there may be some transfer of reactants or H_2O from one phase to another within the bomb vessel during the heating process.

The value of ϵ_{R} is obtained in a separate calibration experiment. The calibration is usually carried out with the combustion of a reference substance, such as benzoic acid, whose internal energy of combustion under controlled conditions is precisely known from standardization based on electrical work. If the bomb vessel is immersed in the same mass of water in both experiments and other conditions are similar, the difference in the values of ϵ_{R} in the two experiments is equal to the known difference in the heat capacities of the initial contents (reactants, water, etc.) of the bomb vessel in the two experiments.

The internal energy change we wish to find is $\Delta U(\text{IBP}, T_2)$, that of the isothermal bomb process in which reactants change to products at temperature T_2 , accompanied perhaps by some further transfer of substances between phases. From Eqs. 11.5.4 and 11.5.5, we obtain

$$\Delta U(\text{IBP}, T_2) = -\epsilon(T_2 - T_1) + \Delta U(\text{expt}) \quad (11.5.6)$$

The value of $\Delta U(\text{expt})$ is small. To evaluate it, we must look in detail at the possible sources of energy transfer between the system and the surroundings during the experimental process. These sources are

1. electrical work w_{ign} done on the system by the ignition circuit;

¹²When one investigates a combustion reaction, the path in which temperature changes without reaction is best taken with reactants rather than products present because the reactants are more easily characterized.

2. heat transfer, minimized but not eliminated by the jacket;
3. mechanical stirring work done on the system;
4. electrical work done on the system by an electrical thermometer.

The ignition work occurs during only a short time interval at the beginning of the process, and its value is known. The effects of heat transfer, stirring work, and temperature measurement continue throughout the course of the experiment. With these considerations, Eq. 11.5.6 becomes

$$\Delta U(\text{IBP}, T_2) = -\epsilon(T_2 - T_1) + w_{\text{ign}} + \Delta U'(\text{expt}) \quad (11.5.7)$$

where $\Delta U'(\text{expt})$ is the internal energy change due to heat, stirring, and temperature measurement. $\Delta U'(\text{expt})$ can be evaluated from the energy equivalent and the observed rates of temperature change at times t_1 and t_2 ; the relevant relations for an isothermal jacket are Eq. 7.3.24 (with w_{el} set equal to zero) and Eq. 7.3.32.

Correction to the reference temperature

The value of $\Delta U(\text{IBP}, T_2)$ evaluated from Eq. 11.5.7 is the internal energy change of the isothermal bomb process at temperature T_2 . We need to correct this value to the desired reference temperature T_{ref} . If T_2 and T_{ref} are close in value, the correction is small and can be calculated with a modified version of the Kirchhoff equation (Eq. 11.3.10 on page 325):

$$\Delta U(\text{IBP}, T_{\text{ref}}) = \Delta U(\text{IBP}, T_2) + [C_V(\text{P}) - C_V(\text{R})](T_{\text{ref}} - T_2) \quad (11.5.8)$$

Here $C_V(\text{P})$ and $C_V(\text{R})$ are the heat capacities at constant volume of the contents of the bomb vessel with products and reactants, respectively, present.

Reduction to standard states

We want to obtain the value of $\Delta_c U^\circ(T_{\text{ref}})$, the molar internal energy change for the main combustion reaction at the reference temperature under standard-state conditions. Once we have this value, it is an easy matter to find the molar *enthalpy* change under standard-state conditions, our ultimate goal.

Consider a hypothetical process with the following three isothermal steps carried out at the reference temperature T_{ref} :

1. Each substance initially present in the bomb vessel changes from its standard state to the state it actually has at the start of the isothermal bomb process.
2. The isothermal bomb process takes place, including the main combustion reaction and any side reactions and auxiliary reactions.
3. Each substance present in the final state of the isothermal bomb process changes to its standard state.

The net change is a decrease in the amount of each reactant in its standard state and an increase in the amount of each product in its standard state. The internal energy change of step 2 is $\Delta U(\text{IBP}, T_{\text{ref}})$, whose value is found from Eq. 11.5.8. The internal energy changes of steps 1 and 3 are called **Washburn corrections**.¹³

¹³Ref. [182].

Thus, we calculate the standard internal energy change of the main combustion reaction at temperature T_{ref} from

$$\Delta U^\circ(\text{cmb}, T_{\text{ref}}) = \Delta U(\text{IBP}, T_{\text{ref}}) + (\text{Washburn corrections}) - \sum_i \Delta \xi_i \Delta_r U^\circ(i) \quad (11.5.9)$$

where the sum over i is for side reactions and auxiliary reactions if present. Finally, we calculate the standard *molar* internal energy of combustion from

$$\Delta_c U^\circ(T_{\text{ref}}) = \frac{\Delta U^\circ(\text{cmb}, T_{\text{ref}})}{\Delta \xi_c} \quad (11.5.10)$$

where $\Delta \xi_c$ is the advancement of the main combustion reaction in the bomb vessel.

Standard molar enthalpy change

The quantity $\Delta_c U^\circ(T_{\text{ref}})$ is the molar internal energy change for the main combustion reaction carried out at constant temperature T_{ref} with each reactant and product in its standard state at pressure p° . From the relations $\Delta_c H = \sum_i \nu_i H_i$ (Eq. 11.2.15) and $H_i = U_i + pV_i$ (from Eq. 9.2.50), we get

$$\Delta_c H^\circ(T_{\text{ref}}) = \Delta_c U^\circ(T_{\text{ref}}) + p^\circ \sum_i \nu_i V_i^\circ \quad (11.5.11)$$

Molar volumes of condensed phases are much smaller than those of gases, and to a good approximation we may write

$$\Delta_c H^\circ(T_{\text{ref}}) = \Delta_c U^\circ(T_{\text{ref}}) + p^\circ \sum_i \nu_i^g V_i^\circ(\text{g}) \quad (11.5.12)$$

where the sum includes only gaseous reactants and products of the main combustion reaction. Since a gas in its standard state is an ideal gas with molar volume equal to RT/p° , the final relation is

$$\Delta_c H^\circ(T_{\text{ref}}) = \Delta_c U^\circ(T_{\text{ref}}) + \sum_i \nu_i^g RT_{\text{ref}} \quad (11.5.13)$$

Washburn corrections

The Washburn corrections needed in Eq. 11.5.9 are internal energy changes for certain hypothetical physical processes occurring at the reference temperature T_{ref} involving the substances present in the bomb vessel. In these processes, substances change from their standard states to the initial state of the isothermal bomb process, or change from the final state of the isothermal bomb process to their standard states.

For example, consider the complete combustion of a solid or liquid compound of carbon, hydrogen, and oxygen in which the combustion products are CO_2 and H_2O and there are no side reactions or auxiliary reactions. In the initial state of the isothermal bomb process, the bomb vessel contains the pure reactant, liquid water with O_2 dissolved in it, and a gaseous mixture of O_2 and H_2O , all at a high pressure p_1 . In the final state, the bomb vessel contains liquid water with O_2 and CO_2 dissolved in it and a gaseous mixture of O_2 , H_2O , and CO_2 , all at pressure p_2 . In addition, the bomb vessel contains internal parts of constant mass such as the sample holder and ignition wires.

In making Washburn corrections, we must use a single standard state for each substance in order for Eq. 11.5.9 to correctly give the standard internal energy of combustion. In the present example we choose the following standard states: pure solid or liquid for the reactant compound, pure liquid for the H_2O , and pure ideal gases for the O_2 and CO_2 , each at pressure $p^\circ = 1$ bar.

We can calculate the amount of each substance in each phase, in both the initial state and final state of the isothermal bomb process, from the following information: the internal volume of the bomb vessel; the mass of solid or liquid reactant initially placed in the vessel; the initial amount of H_2O ; the initial O_2 pressure; the water vapor pressure; the solubilities (estimated from Henry's law constants) of O_2 and CO_2 in the water; and the stoichiometry of the combustion reaction. Problem 11.7 on page 362 guides you through these calculations.

11.5.3 Other calorimeters

Experimenters have used great ingenuity in designing calorimeters to measure reaction enthalpies and to improve their precision. In addition to the constant-pressure reaction calorimeter and bomb calorimeter described above, three additional types will be briefly mentioned.

A *phase-change calorimeter* has two coexisting phases of a pure substance in thermal contact with the reaction vessel and an adiabatic outer jacket. The two coexisting phases constitute a univariant subsystem that at constant pressure is at the fixed temperature of the equilibrium phase transition. The thermal energy released or absorbed by the reaction, instead of changing the temperature, is transferred isothermally to or from the coexisting phases and can be measured by the volume change of the phase transition. A reaction enthalpy, of course, can only be measured by this method at the temperature of the equilibrium phase transition. The well-known Bunsen ice calorimeter uses the ice–water transition at 0°C . The solid–liquid transition of diphenyl ether has a relatively large volume change and is useful for measurements at 26.9°C . Phase-transition calorimeters are especially useful for slow reactions.

A *heat-flow calorimeter* is a variation of an isothermal-jacket calorimeter. It uses a thermopile (Sec. 2.3.6) to continuously measure the temperature difference between the reaction vessel and an outer jacket acting as a constant-temperature heat sink. The heat transfer takes place mostly through the thermocouple wires, and to a high degree of accuracy is proportional to the temperature difference integrated over time. This is the best method for an extremely slow reaction, and it can also be used for rapid reactions.

A *flame calorimeter* is a flow system in which oxygen, fluorine, or another gaseous oxidant reacts with a gaseous fuel. The heat transfer between the flow tube and a heat sink can be measured with a thermopile, as in a heat-flow calorimeter.

11.6 Adiabatic Flame Temperature

With a few simple approximations, we can estimate the temperature of a flame formed in a flowing gas mixture of oxygen or air and a fuel. We treat a moving segment of the gas mixture as a closed system in which the temperature increases as combustion takes place. We assume that the reaction occurs at a constant pressure equal to the standard pressure, and that the process is adiabatic and the gas is an ideal-gas mixture.

The principle of the calculation is similar to that used for a constant-pressure calorimeter as explained by the paths shown in Fig. 11.11 on page 335. When the combustion reaction in the segment of gas reaches reaction equilibrium, the advancement has changed by $\Delta\xi$ and the temperature has increased from T_1 to T_2 . Because the reaction is assumed to be adiabatic at constant pressure, $\Delta H(\text{expt})$ is zero. Therefore, the sum of $\Delta H(\text{rxn}, T_1)$ and $\Delta H(P)$ is zero, and we can write

$$\Delta\xi\Delta_c H^\circ(T_1) + \int_{T_1}^{T_2} C_p(P) dT = 0 \quad (11.6.1)$$

where $\Delta_c H^\circ(T_1)$ is the standard molar enthalpy of combustion at the initial temperature, and $C_p(P)$ is the heat capacity at constant pressure of the product mixture.

The value of T_2 that satisfies Eq. 11.6.1 is the *estimated* flame temperature. Problem 11.9 presents an application of this calculation. Several factors cause the actual temperature in a flame to be lower: the process is never completely adiabatic, and in the high temperature of the flame there may be product dissociation and other reactions in addition to the main combustion reaction.

11.7 Gibbs Energy and Reaction Equilibrium

This section begins by examining the way in which the Gibbs energy changes as a chemical process advances in a closed system at constant T and p with expansion work only. A universal criterion for reaction equilibrium is derived involving the molar reaction Gibbs energy.

11.7.1 The molar reaction Gibbs energy

Applying the general definition of a molar differential reaction quantity (Eq. 11.2.15) to the Gibbs energy of a closed system with T , p , and ξ as the independent variables, we obtain the definition of the **molar reaction Gibbs energy** or molar Gibbs energy of reaction, $\Delta_r G$:

$$\Delta_r G \stackrel{\text{def}}{=} \sum_i \nu_i \mu_i \quad (11.7.1)$$

Equation 11.2.16 shows that this quantity is also given by the partial derivative

$$\Delta_r G = \left(\frac{\partial G}{\partial \xi} \right)_{T,p} \quad (11.7.2)$$

(closed system)

The total differential of G is then

$$dG = -S dT + V dp + \Delta_r G d\xi \quad (11.7.3)$$

(closed system)

11.7.2 Spontaneity and reaction equilibrium

In Sec. 5.8, we found that the spontaneous direction of a process taking place in a closed system at constant T and p , with expansion work only, is the direction of decreasing G . In

the case of a chemical process occurring at constant T and p , $\Delta_r G$ is the rate at which G changes with ξ . Thus if $\Delta_r G$ is positive, ξ spontaneously decreases; if $\Delta_r G$ is negative, ξ spontaneously increases. During a spontaneous process $d\xi$ and $\Delta_r G$ have opposite signs.¹⁴

Note how the equality of Eq. 11.7.3 agrees with the inequality $dG < -S dT + V dp$, a criterion of spontaneity in a closed system with expansion work only (Eq. 5.8.6 on page 149). When $d\xi$ and $\Delta_r G$ have opposite signs, $\Delta_r G d\xi$ is negative and $dG = (-S dT + V dp + \Delta_r G d\xi)$ is less than $(-S dT + V dp)$.

If the system is closed and contains at least one phase that is a mixture, a state of reaction equilibrium can be approached spontaneously at constant T and p in either direction of the reaction; that is, by both positive and negative changes of ξ . In this equilibrium state, therefore, G has its minimum value for the given T and p . Since G is a smooth function of ξ , its rate of change with respect to ξ is zero in the equilibrium state. The condition for *reaction equilibrium*, then, is that $\Delta_r G$ must be zero:

$$\Delta_r G = \sum_i \nu_i \mu_i = 0 \quad (11.7.4)$$

(reaction equilibrium)

It is important to realize that this condition is independent of whether or not reaction equilibrium is approached at constant temperature and pressure. It is a universal criterion of reaction equilibrium. The value of $\Delta_r G$ is equal to $\sum_i \nu_i \mu_i$ and depends on the state of the system. If the state is such that $\Delta_r G$ is positive, the direction of spontaneous change is one that, under the existing constraints, allows $\Delta_r G$ to decrease. If $\Delta_r G$ is negative, the spontaneous change increases the value of $\Delta_r G$. When the system reaches reaction equilibrium, whatever the path of the spontaneous process, the value of $\Delta_r G$ becomes zero.

11.7.3 General derivation

We can obtain the condition of reaction equilibrium given by Eq. 11.7.4 in a more general and rigorous way by an extension of the derivation of Sec. 9.2.7, which was for equilibrium conditions in a multiphase, multicomponent system.

Consider a system with a reference phase, α' , and optionally other phases labeled by $\alpha \neq \alpha'$. Each phase contains one or more species labeled by subscript i , and some or all of the species are the reactants and products of a reaction.

The total differential of the internal energy is given by Eq. 9.2.37 on page 238:

$$dU = T^{\alpha'} dS^{\alpha'} - p^{\alpha'} dV^{\alpha'} + \sum_i \mu_i^{\alpha'} dn_i^{\alpha'} + \sum_{\alpha \neq \alpha'} \left(T^\alpha dS^\alpha - p^\alpha dV^\alpha + \sum_i \mu_i^\alpha dn_i^\alpha \right) \quad (11.7.5)$$

¹⁴Sometimes reaction spontaneity at constant T and p is ascribed to the “driving force” of a quantity called the *affinity of reaction*, defined as the negative of $\Delta_r G$. ξ increases spontaneously if the affinity is positive and decreases spontaneously if the affinity is negative; the system is at equilibrium when the affinity is zero.

The conditions of isolation are

$$dU = 0 \quad (\text{constant internal energy}) \quad (11.7.6)$$

$$dV^{\alpha'} + \sum_{\alpha \neq \alpha'} dV^{\alpha} = 0 \quad (\text{no expansion work}) \quad (11.7.7)$$

For each species i :

$$dn_i^{\alpha'} + \sum_{\alpha \neq \alpha'} dn_i^{\alpha} = v_i d\xi \quad (\text{closed system}) \quad (11.7.8)$$

In Eq. 11.7.8, $dn_i^{\alpha''}$ should be set equal to zero for a species i' that is excluded from phase α'' , and $v_{i''}$ should be set equal to zero for a species i'' that is not a reactant or product of the reaction.

We use these conditions of isolation to substitute for dU , $dV^{\alpha'}$, and $dn_i^{\alpha'}$ in Eq. 11.7.5, and make the further substitution $dS^{\alpha'} = dS - \sum_{\alpha \neq \alpha'} dS^{\alpha}$. Solving for dS , we obtain

$$\begin{aligned} dS = & \sum_{\alpha \neq \alpha'} \frac{(T^{\alpha'} - T^{\alpha})}{T^{\alpha'}} dS^{\alpha} - \sum_{\alpha \neq \alpha'} \frac{(p^{\alpha'} - p^{\alpha})}{T^{\alpha'}} dV^{\alpha} \\ & + \sum_i \sum_{\alpha \neq \alpha'} \frac{(\mu_i^{\alpha'} - \mu_i^{\alpha})}{T^{\alpha'}} dn_i^{\alpha} - \frac{\sum_i v_i \mu_i^{\alpha'}}{T^{\alpha'}} d\xi \end{aligned} \quad (11.7.9)$$

The equilibrium condition is that the coefficient multiplying each differential on the right side of Eq. 11.7.9 must be zero. We conclude that at equilibrium the temperature of each phase is equal to that of phase α' ; the pressure of each phase is equal to that of phase α' ; the chemical potential of each species, in each phase containing that species, is equal to the chemical potential of the species in phase α' ; and the quantity $\sum_i v_i \mu_i^{\alpha'}$ (which is equal to $\Delta_r G$) is zero.

In short, *in an equilibrium state each phase has the same temperature and the same pressure, each species has the same chemical potential in the phases in which it is present, and the molar reaction Gibbs energy of each phase is zero.*

11.7.4 Pure phases

Consider a chemical process in which each reactant and product is in a separate pure phase. For example, the decomposition of calcium carbonate, $\text{CaCO}_3(\text{s}) \rightarrow \text{CaO}(\text{s}) + \text{CO}_2(\text{g})$, involves three pure phases if no other gas is allowed to mix with the CO_2 .

As this kind of reaction advances at constant T and p , the chemical potential of each substance remains constant, and $\Delta_r G$ is therefore constant. The value of $\Delta_r G$ for this reaction depends only on T and p . If $\Delta_r G$ is negative, the reaction proceeds spontaneously to the right until one of the reactants is exhausted; the reaction is said to “go to completion.” If $\Delta_r G$ is positive, the reaction proceeds spontaneously to the left until one of the products is exhausted.¹⁵ The reactants and products can remain in equilibrium only if T and p are such that $\Delta_r G$ is zero. These three cases are illustrated in Fig. 11.14 on the next page.

¹⁵Keep in mind that whether a species is called a reactant or a product depends, not on whether its amount decreases or increases during a reaction process, but rather on which side of the reaction equation it appears.

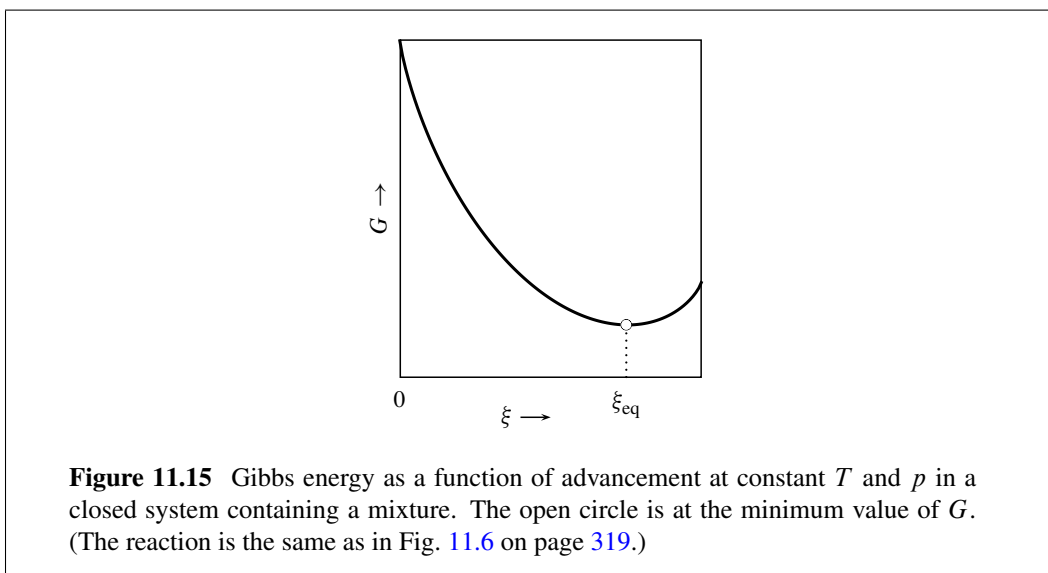
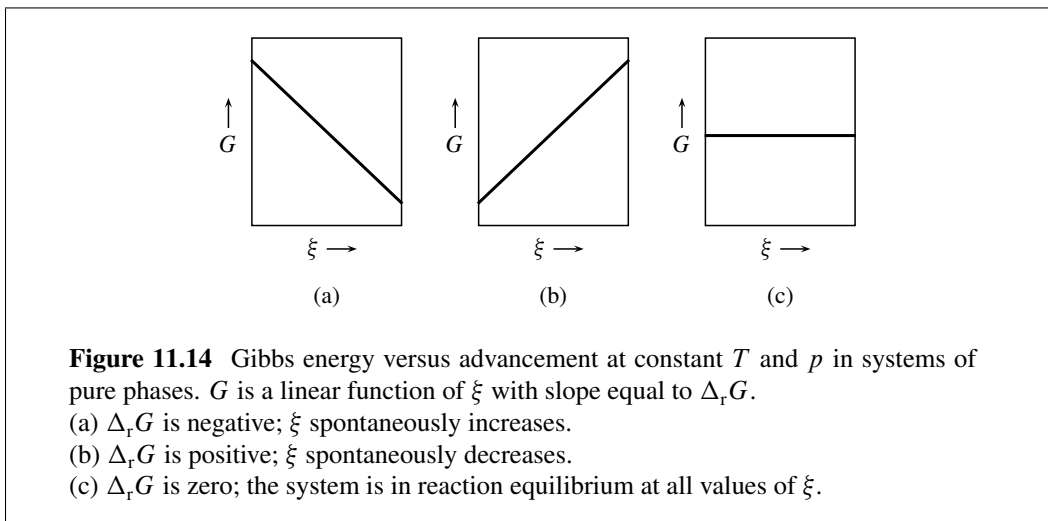

Note the similarity of this behavior to that of an equilibrium phase transition of a pure substance. Only one phase of a pure substance is present at equilibrium unless $\Delta_{\text{trs}} G$ is zero. A phase transition is a special case of a chemical process.

11.7.5 Reactions involving mixtures

If any of the reactants or products of a chemical process taking place in a closed system is a constituent of a mixture, a plot of G versus ξ (at constant T and p) turns out to exhibit a minimum with a slope of zero; see the example in Fig. 11.15. At constant T and p , ξ changes spontaneously in the direction of decreasing G until the minimum is reached, at which point $\Delta_r G$ (the slope of the curve) is zero and the system is in a state of reaction equilibrium.

The condition of reaction equilibrium given by $\Delta_r G=0$ or $\sum_i v_i \mu_i=0$ is a general one that is valid whether or not the reaction proceeds at constant T and p . Suppose a sponta-

neous reaction occurs in a closed system at constant temperature and *volume*. The system is at reaction equilibrium when $\sum_i \nu_i \mu_i$ becomes equal to zero. To relate this condition to the change of a thermodynamic potential, we take the expression for the total differential of the Helmholtz energy of an open system, with expansion work only, given by Eq. 5.5.8 on page 145:

$$dA = -S dT - p dV + \sum_i \mu_i dn_i \quad (11.7.10)$$

When we make the substitution $dn_i = \nu_i d\xi$, we obtain an expression for the total differential of A in a closed system with a chemical reaction:

$$dA = -S dT - p dV + \left(\sum_i \nu_i \mu_i \right) d\xi \quad (11.7.11)$$

We identify the coefficient of the last term on the right as a partial derivative:

$$\sum_i \nu_i \mu_i = \left(\frac{\partial A}{\partial \xi} \right)_{T,V} \quad (11.7.12)$$

This equation shows that as the reaction proceeds spontaneously at constant T and V , it reaches reaction equilibrium at the point where $(\partial A / \partial \xi)_{T,V}$ is zero. This is simply another way to express the criterion for spontaneity stated on page 149: If the only work is expansion work, the Helmholtz energy of a closed system decreases during a spontaneous process at constant T and V and has its minimum value when the system attains an equilibrium state.

11.7.6 Reaction in an ideal gas mixture

Let us look in detail at the source of the minimum in G for the case of a reaction occurring in an ideal gas mixture in a closed system at constant T and p . During this process the system has only one independent variable, which it is convenient to choose as the advancement ξ . The additivity rule (Eq. 9.2.25) for the Gibbs energy is

$$G = \sum_i n_i \mu_i \quad (11.7.13)$$

where both n_i and μ_i depend on ξ . Thus, G is a complicated function of ξ .

For the chemical potential of each substance, we write $\mu_i = \mu_i^\circ(\text{g}) + RT \ln(p_i/p^\circ)$ (Eq. 9.3.5), where p_i is the partial pressure of i in the mixture. Substitution in Eq. 11.7.13 gives, for the Gibbs energy at any value of ξ ,

$$G(\xi) = \sum_i n_i \left[\mu_i^\circ(\text{g}) + RT \ln \frac{p_i}{p^\circ} \right] \quad (11.7.14)$$

At $\xi = 0$, the amounts and partial pressures have their initial values $n_{i,0}$ and $p_{i,0}$:

$$G(0) = \sum_i n_{i,0} \left[\mu_i^\circ(\text{g}) + RT \ln \frac{p_{i,0}}{p^\circ} \right] \quad (11.7.15)$$

The difference between these two expressions is

$$G(\xi) - G(0) = \sum_i (n_i - n_{i,0}) \mu_i^\circ(\text{g}) + RT \sum_i n_i \ln \frac{p_i}{p^\circ} - RT \sum_i n_{i,0} \ln \frac{p_{i,0}}{p^\circ} \quad (11.7.16)$$

Converting partial pressures to mole fractions with $p_i = y_i p$ and $p_{i,0} = y_{i,0} p$ gives

$$G(\xi) - G(0) = \sum_i (n_i - n_{i,0}) \mu_i^\circ(\text{g}) + RT \sum_i n_i \ln y_i - RT \sum_i n_{i,0} \ln y_{i,0} + RT \sum_i (n_i - n_{i,0}) \ln \frac{p}{p^\circ} \quad (11.7.17)$$

With the substitution $n_i - n_{i,0} = \nu_i \xi$ (Eq. 11.2.11) in the first and last terms on the right side of Eq. 11.7.17, the result is

$$G(\xi) - G(0) = \xi \sum_i \nu_i \mu_i^\circ(\text{g}) + RT \sum_i n_i \ln y_i - RT \sum_i n_{i,0} \ln y_{i,0} + RT \left(\sum_i \nu_i \right) \xi \ln \frac{p}{p^\circ} \quad (11.7.18)$$

The sum $\sum_i \nu_i \mu_i^\circ(\text{g})$ in the first term on the right side of Eq. 11.7.18 is $\Delta_r G^\circ$, the standard molar reaction Gibbs energy. Making this substitution gives finally

$$G(\xi) - G(0) = \xi \Delta_r G^\circ + RT \sum_i n_i \ln y_i - RT \sum_i n_{i,0} \ln y_{i,0} + RT \left(\sum_i \nu_i \right) \xi \ln \frac{p}{p^\circ} \quad (11.7.19)$$

(ideal gas mixture)

There are four terms on the right side of Eq. 11.7.19. The first term is the Gibbs energy change for the reaction of pure reactants to form pure products under standard-state conditions, the second is a mixing term, the third term is constant, and the last term is an adjustment of G from the standard pressure to the pressure of the gas mixture. Note that the first and last terms are proportional to the advancement and cannot be the cause of a minimum in the curve of the plot of G versus ξ . It is the *mixing term* $RT \sum_i n_i \ln y_i$ that is responsible for the observed minimum.¹⁶ This term divided by $n = \sum_i n_i$ is $\Delta G_m^{\text{id}}(\text{mix})$, the molar differential Gibbs energy of mixing to form an ideal mixture (see Eq. 11.1.8 on page 306); the term is also equal to $-nT \Delta S_m^{\text{id}}(\text{mix})$ (Eq. 11.1.9), showing that the minimum is entirely an entropy effect.

Now let us consider specifically the simple reaction

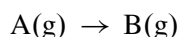

¹⁶This term also causes the slope of the curve of $G(\xi) - G(0)$ versus ξ to be $-\infty$ and $+\infty$ at the left and right extremes of the curve.

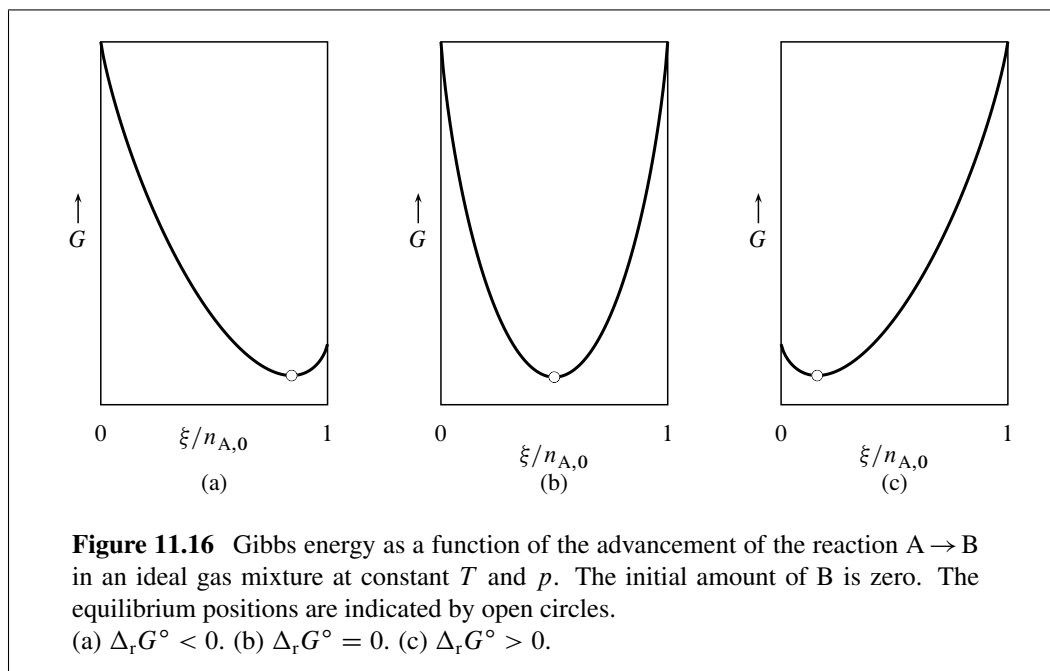

in an ideal gas mixture, for which ν_A is -1 and ν_B is $+1$. Let the initial state be one of pure A: $n_{B,0}=0$. The initial mole fractions are then $y_{A,0}=1$ and $y_{B,0}=0$. In this reaction, the total amount $n = n_A + n_B$ is constant. Substituting these values in Eq. 11.7.19 gives¹⁷

$$G(\xi) - G(0) = \xi \Delta_r G^\circ + nRT(y_A \ln y_A + y_B \ln y_B) \quad (11.7.20)$$

The second term on the right side is $n\Delta G_m^{\text{id}}(\text{mix})$, the Gibbs energy of mixing pure ideal gases A and B at constant T and p to form an ideal gas mixture of composition y_A and y_B . Since the curve of $\Delta G_m^{\text{id}}(\text{mix})$ plotted against ξ has a minimum (as shown in Fig. 11.2 on page 307), $G(\xi) - G(0)$ also has a minimum.

Figure 11.16 illustrates how the position of the minimum, which is the position of reaction equilibrium, depends on the value of $\Delta_r G^\circ$. The more negative is $\Delta_r G^\circ$, the closer to the product side of the reaction is the equilibrium position. On the other hand, the more positive is $\Delta_r G^\circ$, the smaller is the value of ξ at equilibrium. These statements apply to any reaction in a homogeneous mixture.

As the reaction $A \rightarrow B$ proceeds, there is no change in the total number of molecules, and therefore in an ideal gas mixture at constant temperature and volume there is no pressure change. The point of reaction equilibrium is at the minimum of G when both V and p are constant.

The situation is different when the number of molecules changes during the reaction. Consider the reaction $A \rightarrow 2B$ in an ideal gas mixture. As this reaction proceeds to the right at constant T , the volume increases if the pressure is held constant and the pressure increases if the volume is held constant. Figure 11.17 on the next page shows how G depends on both p and V for this reaction. Movement along the horizontal dashed line in the figure corresponds to reaction at constant T and p . The minimum of G along this line is

¹⁷Note that although $\ln y_A$ approaches $-\infty$ as y_A approaches zero, the product $y_A \ln y_A$ approaches zero in this limit. This behavior can be proved with l'Hospital's rule (see any calculus textbook).

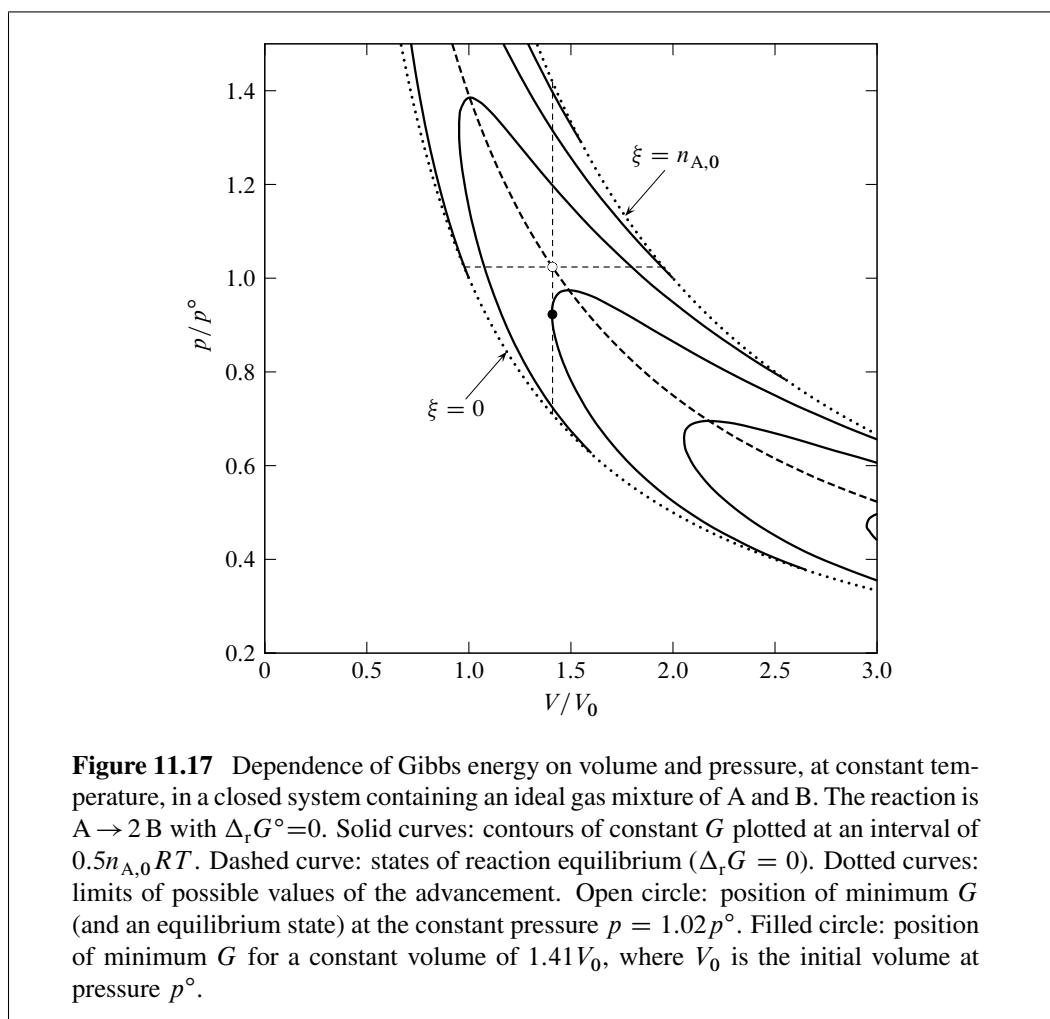

at the volume indicated by the open circle. At this volume, G has an even lower minimum at the pressure indicated by the filled circle, where the vertical dashed line is tangent to one of the contours of constant G . The condition needed for reaction equilibrium, however, is that $\Delta_r G$ must be zero. This condition is satisfied along the vertical dashed line only at the position of the open circle.

This example demonstrates that for a reaction occurring at constant temperature and *volume* in which the pressure changes, the point of reaction equilibrium is not the point of minimum G . Instead, the point of reaction equilibrium in this case is at the minimum of the Helmholtz energy A (Sec. 11.7.5).

11.8 The Thermodynamic Equilibrium Constant

11.8.1 Activities and the definition of K

Equation 10.1.9 gives the general relation between the chemical potential μ_i and the activity a_i of species i in a phase of electric potential ϕ :

$$\mu_i = \mu_i^\circ + RT \ln a_i + z_i F \phi \quad (11.8.1)$$

The electric potential affects μ_i only if the charge number z_i is nonzero, i.e., only if species i is an ion.

Consider a reaction in which any reactants and products that are ions are in a single phase of electric potential ϕ' , or in several phases of equal electric potential ϕ' . Under these conditions, substitution of the expression above for μ_i in $\Delta_r G = \sum_i v_i \mu_i$ gives

$$\Delta_r G = \sum_i v_i \mu_i^\circ + RT \sum_i v_i \ln a_i + F\phi' \sum_i v_i z_i \quad (11.8.2)$$

(all ions at $\phi=\phi'$)

The first term on the right side of Eq. 11.8.2 is the **standard molar reaction Gibbs energy**, or standard molar Gibbs energy of reaction:

$$\Delta_r G^\circ \stackrel{\text{def}}{=} \sum_i v_i \mu_i^\circ \quad (11.8.3)$$

Since the standard chemical potential μ_i° of each species i is a function only of T , the value of $\Delta_r G^\circ$ for a given reaction as defined by the reaction equation depends only on T and on the choice of a standard state for each reactant and product.

The last term on the right side of Eq. 11.8.2 is the sum $\sum_i v_i z_i$. Because charge is conserved during the advancement of a reaction in a closed system, this sum is zero.

With these substitutions, Eq. 11.8.2 becomes

$$\Delta_r G = \Delta_r G^\circ + RT \sum_i v_i \ln a_i \quad (11.8.4)$$

(all ions at same ϕ)

This relation enables us to say that for a reaction at a given temperature in which any charged reactants or products are all in the same phase, or in phases of equal electric potential, the value of $\Delta_r G$ and $\sum_i v_i \mu_i$ depends only on the activities of the reactants and products and is independent of what the electric potentials of any of the phases might happen to be.

Unless a reaction involving ions is carried out in a galvanic cell, the ions are usually present in a single phase, and this will not be shown as a condition of validity in the rest of this chapter. The special case of a reaction in a galvanic cell will be discussed in Sec. 14.3.

We may use properties of logarithms to write the sum on the right side of Eq. 11.8.4 as follows:¹⁸

$$\sum_i v_i \ln a_i = \sum_i \ln (a_i^{v_i}) = \ln \prod_i a_i^{v_i} \quad (11.8.5)$$

The product $\prod_i a_i^{v_i}$ is called the **reaction quotient** or activity quotient, Q_{rxn} :

$$Q_{\text{rxn}} \stackrel{\text{def}}{=} \prod_i a_i^{v_i} \quad (11.8.6)$$

Q_{rxn} consists of a factor for each reactant and product. Each factor is the activity raised to the power of the stoichiometric number v_i . Since the value of v_i is positive for a product and negative for a reactant, Q_{rxn} is a quotient in which the activities of the products appear in the numerator and those of the reactants appear in the denominator, with each activity raised to a power equal to the corresponding stoichiometric coefficient in the reaction equation. Such

¹⁸The symbol \prod stands for a continued product. If, for instance, there are three species, $\prod_i a_i^{v_i}$ is the product $(a_1^{v_1})(a_2^{v_2})(a_3^{v_3})$.

a quotient, with quantities raised to these powers, is called a **proper quotient**. The reaction quotient is a proper quotient of activities.

For instance, for the ammonia synthesis reaction $\text{N}_2(\text{g}) + 3 \text{H}_2(\text{g}) \rightarrow 2 \text{NH}_3(\text{g})$ the reaction quotient is given by

$$Q_{\text{rxn}} = \frac{a_{\text{NH}_3}^2}{a_{\text{N}_2} a_{\text{H}_2}^3} \quad (11.8.7)$$

Q_{rxn} is a dimensionless quantity. It is a function of T , p , and the mixture composition, so its value changes as the reaction advances.

The expression for the molar reaction Gibbs energy given by Eq. 11.8.4 can now be written

$$\Delta_r G = \Delta_r G^\circ + RT \ln Q_{\text{rxn}} \quad (11.8.8)$$

The value of Q_{rxn} under equilibrium conditions is the **thermodynamic equilibrium constant**, K . The general definition of K is

$$K \stackrel{\text{def}}{=} \prod_i (a_i)_{\text{eq}}^{v_i} \quad (11.8.9)$$

where the subscript eq indicates an equilibrium state. Note that K , like Q_{rxn} , is dimensionless.

The IUPAC Green Book¹⁹ gives K° as an alternative symbol for the thermodynamic equilibrium constant, the appended superscript denoting “standard.” An IUPAC Commission on Thermodynamics²⁰ has furthermore recommended the name “standard equilibrium constant,” apparently because its value depends on the choice of standard states. Using this alternative symbol and name could cause confusion, since the quantity defined by Eq. 11.8.9 does not refer to reactants and products in their standard states but rather to reactants and products in an *equilibrium* state.

Substituting the equilibrium conditions $\Delta_r G = 0$ and $Q_{\text{rxn}} = K$ in Eq. 11.8.8 gives an important relation between the standard molar reaction Gibbs energy and the thermodynamic equilibrium constant:

$$\Delta_r G^\circ = -RT \ln K \quad (11.8.10)$$

We can solve this equation for K to obtain the equivalent relation

$$K = \exp\left(-\frac{\Delta_r G^\circ}{RT}\right) \quad (11.8.11)$$

We have seen that the value of $\Delta_r G^\circ$ depends only on T and the choice of the standard states of the reactants and products. This being so, Eq. 11.8.11 shows that the value of K for a given reaction depends only on T and the choice of standard states. No other condition, neither pressure nor composition, can affect the value of K . We also see from Eq. 11.8.11 that K is less than 1 if $\Delta_r G^\circ$ is positive and greater than 1 if $\Delta_r G^\circ$ is negative. At a fixed temperature, reaction equilibrium is attained only if and only if the value of Q_{rxn} becomes equal to the value of K at that temperature.

The thermodynamic equilibrium constant K is the proper quotient of the activities of species in reaction equilibrium. At typical temperatures and pressures, an activity cannot be

¹⁹Ref. [36], p. 58. ²⁰Ref. [54].

many orders of magnitude greater than 1. For instance, a partial pressure cannot be greater than the total pressure, so at a pressure of 10 bar the activity of a gaseous constituent cannot be greater than about 10. The molarity of a solute is rarely much greater than 10 mol dm^{-3} , corresponding to an activity (on a concentration basis) of about 10. Activities can, however, be extremely small.

These considerations lead us to the conclusion that in an equilibrium state of a reaction with a very *large* value of K , the activity of at least one of the *reactants* must be very small. That is, if K is very large then the reaction goes practically to completion and at equilibrium a limiting reactant is essentially entirely exhausted. The opposite case, a reaction with a very *small* value of K , must have at equilibrium one or more *products* with very small activities. These two cases are the two extremes of the trends shown in Fig. 11.16 on page 349.

Equation 11.8.10 correctly relates $\Delta_r G^\circ$ and K only if they are both calculated with the same standard states. For instance, if we base the standard state of a particular solute species on molality in calculating $\Delta_r G^\circ$, the activity of that species appearing in the expression for K (Eq. 11.8.9) must also be based on molality.

11.8.2 Reaction in a gas phase

If a reaction takes place in a gaseous mixture, the standard state of each reactant and product is the pure gas behaving ideally at the standard pressure p° (Sec. 9.3.3). In this case, each activity is given by $a_i(\text{g}) = f_i/p^\circ = \phi_i p_i/p^\circ$ where ϕ_i is a fugacity coefficient (Table 9.5). When we substitute this expression into Eq. 11.8.9, we find we can express the thermodynamic equilibrium constant as the product of three factors:

$$K = \left[\prod_i (\phi_i)_{\text{eq}}^{v_i} \right] \left[\prod_i (p_i)_{\text{eq}}^{v_i} \right] \left[(p^\circ)^{-\sum_i v_i} \right] \quad (11.8.12)$$

(gas mixture)

On the right side of this equation, the first factor is the proper quotient of fugacity coefficients in the mixture at reaction equilibrium, the second factor is the proper quotient of partial pressures in this mixture, and the third factor is the power of p° needed to make K dimensionless.

The proper quotient of equilibrium partial pressures is an **equilibrium constant on a pressure basis**, K_p :

$$K_p = \prod_i (p_i)_{\text{eq}}^{v_i} \quad (11.8.13)$$

(gas mixture)

Note that K_p is dimensionless only if $\sum_i v_i$ is equal to zero.

The value of K_p can vary at constant temperature, so K_p is not a thermodynamic equilibrium constant. For instance, consider what happens when we take an ideal gas mixture at reaction equilibrium and compress it isothermally. As the gas pressure increases, the fugacity coefficient of each constituent changes from its low pressure value of 1 and the gas mixture becomes nonideal. In order for the mixture to remain in reaction equilibrium, and the product of factors on the right side of Eq. 11.8.12 to remain constant, there must be a change in the value of K_p . In other words, the reaction equilibrium *shifts* as we increase p at constant T , an effect that will be considered in more detail in Sec. 11.9.

As an example of the difference between K and K_p , consider again the ammonia synthesis $\text{N}_2(\text{g}) + 3\text{H}_2(\text{g}) \rightarrow 2\text{NH}_3(\text{g})$ in which the sum $\sum_i \nu_i$ equals -2 . For this reaction, the expression for the thermodynamic equilibrium constant is

$$K = \left(\frac{\phi_{\text{NH}_3}^2}{\phi_{\text{N}_2} \phi_{\text{H}_2}^3} \right)_{\text{eq}} K_p(p^\circ)^2 \quad (11.8.14)$$

where K_p is given by

$$K_p = \left(\frac{p_{\text{NH}_3}^2}{p_{\text{N}_2} p_{\text{H}_2}^3} \right)_{\text{eq}} \quad (11.8.15)$$

11.8.3 Reaction in solution

If any of the reactants or products are solutes in a solution, the value of K depends on the choice of the solute standard state.

For a given reaction at a given temperature, we can derive relations between values of K that are based on different solute standard states. In the limit of infinite dilution, each solute activity coefficient is unity, and at the standard pressure each pressure factor is unity. Under these conditions of infinite dilution and standard pressure, the activities of solute B on a mole fraction, concentration, and molality basis are therefore

$$a_{x,\text{B}} = x_{\text{B}} \quad a_{c,\text{B}} = c_{\text{B}}/c^\circ \quad a_{m,\text{B}} = m_{\text{B}}/m^\circ \quad (11.8.16)$$

In the limit of infinite dilution, the solute composition variables approach values given by the relations in Eq. 9.1.14 on page 227: $x_{\text{B}} = V_{\text{A}}^* c_{\text{B}} = M_{\text{A}} m_{\text{B}}$. Combining these with $a_{x,\text{B}} = x_{\text{B}}$ from Eq. 11.8.16, we write

$$a_{x,\text{B}} = V_{\text{A}}^* c_{\text{B}} = M_{\text{A}} m_{\text{B}} \quad (11.8.17)$$

Then, using the relations for $a_{c,\text{B}}$ and $a_{m,\text{B}}$ in Eq. 11.8.16, we find that the activities of solute B at infinite dilution and pressure p° are related by

$$a_{x,\text{B}} = V_{\text{A}}^* c^\circ a_{c,\text{B}} = M_{\text{A}} m^\circ a_{m,\text{B}} \quad (11.8.18)$$

The expression $K = \prod_i (a_i)_{\text{eq}}^{\nu_i}$ has a factor $(a_{\text{B}})_{\text{eq}}^{\nu_{\text{B}}}$ for each solute B that is a reactant or product. From Eq. 11.8.18, we see that for solutes at infinite dilution at pressure p° , the relations between the values of K based on different solute standard states are

$$K(x \text{ basis}) = \prod_{\text{B}} (V_{\text{A}}^* c^\circ)^{\nu_{\text{B}}} K(c \text{ basis}) = \prod_{\text{B}} (M_{\text{A}} m^\circ)^{\nu_{\text{B}}} K(m \text{ basis}) \quad (11.8.19)$$

For a given reaction at a given temperature, and with a given choice of solute standard state, the value of K is not affected by pressure or dilution. The relations of Eq. 11.8.19 are therefore valid under all conditions.

11.8.4 Evaluation of K

The relation $K = \exp(-\Delta_r G^\circ/RT)$ (Eq. 11.8.11) gives us a way to evaluate the thermodynamic equilibrium constant K of a reaction at a given temperature from the value of the standard molar reaction Gibbs energy $\Delta_r G^\circ$ at that temperature. If we know the value of $\Delta_r G^\circ$, we can calculate the value of K .

One method is to calculate $\Delta_r G^\circ$ from values of the **standard molar Gibbs energy of formation** $\Delta_f G^\circ$ of each reactant and product. These values are the standard molar reaction Gibbs energies for the formation reactions of the substances. To relate $\Delta_r G^\circ$ to measurable quantities, we make the substitution $\mu_i = H_i - TS_i$ (Eq. 9.2.46) in $\Delta_r G = \sum_i \nu_i \mu_i$ to give $\Delta_r G = \sum_i \nu_i H_i - T \sum_i \nu_i S_i$, or

$$\Delta_r G = \Delta_r H - T \Delta_r S \quad (11.8.20)$$

When we apply this equation to a reaction with each reactant and product in its standard state, it becomes

$$\Delta_r G^\circ = \Delta_r H^\circ - T \Delta_r S^\circ \quad (11.8.21)$$

where the standard molar reaction entropy is given by

$$\Delta_r S^\circ = \sum_i \nu_i S_i^\circ \quad (11.8.22)$$

If the reaction is the *formation* reaction of a substance, we have

$$\Delta_f G^\circ = \Delta_f H^\circ - T \sum_i \nu_i S_i^\circ \quad (11.8.23)$$

where the sum over i is for the reactants and product of the formation reaction. We can evaluate the standard molar Gibbs energy of formation of a substance, then, from its standard molar enthalpy of formation and the standard molar entropies of the reactants and product.

Extensive tables are available of values of $\Delta_f G^\circ$ for substances and ions. An abbreviated version at the single temperature 298.15 K is given in Appendix H. For a reaction of interest, the tabulated values enable us to evaluate $\Delta_r G^\circ$, and then K , from the expression (analogous to Hess's law)

$$\Delta_r G^\circ = \sum_i \nu_i \Delta_f G^\circ(i) \quad (11.8.24)$$

The sum over i is for the reactants and products of the reaction of interest.

Recall that the standard molar enthalpies of formation needed in Eq. 11.8.23 can be evaluated by calorimetric methods (Sec. 11.3.2). The absolute molar entropy values S_i° come from heat capacity data or statistical mechanical theory by methods discussed in Sec. 6.2. Thus, it is entirely feasible to use nothing but calorimetry to evaluate an equilibrium constant, a goal sought by thermodynamicists during the first half of the 20th century.²¹

For *ions in aqueous solution*, the values of S_m° and $\Delta_f G^\circ$ found in Appendix H are based on the reference values $S_m^\circ=0$ and $\Delta_f G^\circ=0$ for $H^+(aq)$ at all temperatures, similar to the convention for $\Delta_f H^\circ$ values discussed in Sec. 11.3.2.²² For a reaction with aqueous ions as reactants or products, these values correctly give $\Delta_r S^\circ$ using Eq. 11.8.22, or $\Delta_r G^\circ$ using Eq. 11.8.24.

²¹Another method, for a reaction that can be carried out reversibly in a galvanic cell, is described in Sec. 14.3.3.

²²Note that the values of S_m° in Appendix H for some ions, unlike the values for substances, are *negative*; this simply means that the standard molar entropies of these ions are less than that of $H^+(aq)$.

The relation of Eq. 11.8.23 does not apply to an ion, because we cannot write a formation reaction for a single ion. Instead, the relation between $\Delta_f G^\circ$, $\Delta_f H^\circ$ and S_m° is more complicated.

Consider first a hypothetical reaction in which hydrogen ions and one or more elements form H_2 and a cation M^{z+} with charge number z_+ :

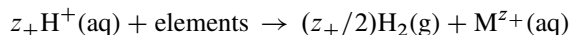

For this reaction, using the convention that $\Delta_f H^\circ$, S_m° , and $\Delta_f G^\circ$ are zero for the aqueous H^+ ion and the fact that $\Delta_f H^\circ$ and $\Delta_f G^\circ$ are zero for the elements, we can write the following expressions for standard molar reaction quantities:

$$\Delta_r H^\circ = \Delta_f H^\circ(M^{z+}) \quad (11.8.25)$$

$$\Delta_r S^\circ = (z_+/2)S_m^\circ(H_2) + S_m^\circ(M^{z+}) - \sum_{\text{elements}} S_i^\circ \quad (11.8.26)$$

$$\Delta_r G^\circ = \Delta_f G^\circ(M^{z+}) \quad (11.8.27)$$

Then, from $\Delta_r G^\circ = \Delta_r H^\circ - T\Delta_r S^\circ$, we find

$$\begin{aligned} \Delta_f G^\circ(M^{z+}) &= \Delta_f H^\circ(M^{z+}) \\ &\quad - T \left[S_m^\circ(M^{z+}) - \sum_{\text{elements}} S_i^\circ + (z_+/2)S_m^\circ(H_2) \right] \end{aligned} \quad (11.8.28)$$

For example, the standard molar Gibbs energy of the aqueous mercury(I) ion is found from

$$\begin{aligned} \Delta_f G^\circ(Hg_2^{2+}) &= \Delta_f H^\circ(Hg_2^{2+}) - TS_m^\circ(Hg_2^{2+}) \\ &\quad + 2TS_m^\circ(Hg) - \frac{2}{2}TS_m^\circ(H_2) \end{aligned} \quad (11.8.29)$$

For an anion X^{z-} with negative charge number z_- , using the hypothetical reaction

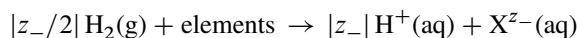

we find by the same method

$$\begin{aligned} \Delta_f G^\circ(X^{z-}) &= \Delta_f H^\circ(X^{z-}) \\ &\quad - T \left[S_m^\circ(X^{z-}) - \sum_{\text{elements}} S_i^\circ - |z_-/2|S_m^\circ(H_2) \right] \end{aligned} \quad (11.8.30)$$

For example, the calculation for the nitrate ion is

$$\begin{aligned} \Delta_f G^\circ(NO_3^-) &= \Delta_f H^\circ(NO_3^-) - TS_m^\circ(NO_3^-) \\ &\quad + \frac{1}{2}TS_m^\circ(N_2) + \frac{3}{2}TS_m^\circ(O_2) + \frac{1}{2}TS_m^\circ(H_2) \end{aligned} \quad (11.8.31)$$

11.9 Effects of Temperature and Pressure on Equilibrium Position

The advancement ξ of a chemical reaction in a closed system describes the changes in the amounts of the reactants and products from specified initial values of these amounts. We have seen that if the system is maintained at constant temperature and pressure, ξ changes spontaneously in the direction that decreases the Gibbs energy. The change continues until the system reaches a state of reaction equilibrium at the minimum of G . The value of the advancement in this equilibrium state will be denoted ξ_{eq} , as shown in Fig. 11.15 on page 346. The value of ξ_{eq} depends in general on the values of T and p . Thus when we change the temperature or pressure of a closed system that is at equilibrium, ξ_{eq} usually changes also and the reaction spontaneously *shifts* to a new equilibrium position.

To investigate this effect, we write the total differential of G with T , p , and ξ as independent variables

$$dG = -S dT + V dp + \Delta_r G d\xi \quad (11.9.1)$$

and obtain the reciprocity relations

$$\left(\frac{\partial \Delta_r G}{\partial T}\right)_{p, \xi} = -\left(\frac{\partial S}{\partial \xi}\right)_{T, p} \quad \left(\frac{\partial \Delta_r G}{\partial p}\right)_{T, \xi} = \left(\frac{\partial V}{\partial \xi}\right)_{T, p} \quad (11.9.2)$$

We recognize the partial derivative on the right side of each of these relations as a molar differential reaction quantity:

$$\left(\frac{\partial \Delta_r G}{\partial T}\right)_{p, \xi} = -\Delta_r S \quad \left(\frac{\partial \Delta_r G}{\partial p}\right)_{T, \xi} = \Delta_r V \quad (11.9.3)$$

We use these expressions for two of the coefficients in an expression for the total differential of $\Delta_r G$:

$$d\Delta_r G = -\Delta_r S dT + \Delta_r V dp + \left(\frac{\partial \Delta_r G}{\partial \xi}\right)_{T, p} d\xi \quad (11.9.4)$$

(closed system)

Since $\Delta_r G$ is the partial derivative of G with respect to ξ at constant T and p , the coefficient $(\partial \Delta_r G / \partial \xi)_{T, p}$ is the partial *second* derivative of G with respect to ξ :

$$\left(\frac{\partial \Delta_r G}{\partial \xi}\right)_{T, p} = \left(\frac{\partial^2 G}{\partial \xi^2}\right)_{T, p} \quad (11.9.5)$$

We know that at a fixed T and p , a plot of G versus ξ has a slope at each point equal to $\Delta_r G$ and a minimum at the position of reaction equilibrium where ξ is ξ_{eq} . At the minimum of the plotted curve, the slope $\Delta_r G$ is zero and the second derivative is positive (see Fig. 11.15 on page 346). By setting $\Delta_r G$ equal to zero in the general relation $\Delta_r G = \Delta_r H - T\Delta_r S$, we obtain the equation $\Delta_r S = \Delta_r H / T$ which is valid only at reaction equilibrium where ξ equals ξ_{eq} . Making this substitution in Eq. 11.9.4, and setting $d\Delta_r G$ equal to zero and $d\xi$ equal to $d\xi_{\text{eq}}$, we obtain

$$0 = -\frac{\Delta_r H}{T} dT + \Delta_r V dp + \left(\frac{\partial^2 G}{\partial \xi^2}\right)_{T, p} d\xi_{\text{eq}} \quad (11.9.6)$$

(closed system)

which shows how infinitesimal changes in T , p , and ξ_{eq} are related.

Now we are ready to see how ξ_{eq} is affected by changes in T or p . Solving Eq. 11.9.6 for $d\xi_{\text{eq}}$ gives

$$d\xi_{\text{eq}} = \frac{\Delta_r H}{T} dT - \Delta_r V dp \quad (11.9.7)$$

$$\left(\frac{\partial^2 G}{\partial \xi^2} \right)_{T,p} \quad (\text{closed system})$$

The right side of Eq. 11.9.7 is the expression for the total differential of ξ in a closed system at reaction equilibrium, with T and p as the independent variables. Thus, at constant pressure the equilibrium shifts with temperature according to

$$\left(\frac{\partial \xi_{\text{eq}}}{\partial T} \right)_p = \frac{\Delta_r H}{T \left(\frac{\partial^2 G}{\partial \xi^2} \right)_{T,p}} \quad (11.9.8)$$

(closed system)

and at constant temperature the equilibrium shifts with pressure according to

$$\left(\frac{\partial \xi_{\text{eq}}}{\partial p} \right)_T = - \frac{\Delta_r V}{\left(\frac{\partial^2 G}{\partial \xi^2} \right)_{T,p}} \quad (11.9.9)$$

(closed system)

Because the partial second derivative $(\partial^2 G / \partial \xi^2)_{T,p}$ is positive, Eqs. 11.9.8 and 11.9.9 show that $(\partial \xi_{\text{eq}} / \partial T)_p$ and $\Delta_r H$ have the same sign, whereas $(\partial \xi_{\text{eq}} / \partial p)_T$ and $\Delta_r V$ have opposite signs.

These statements express the application to temperature and pressure changes of what is known as *Le Châtelier's principle*: When a change is made to a closed system at equilibrium, the equilibrium shifts in the direction that tends to oppose the change. Here are two examples.

1. Suppose $\Delta_r H$ is negative—the reaction is exothermic. Since $(\partial \xi_{\text{eq}} / \partial T)_p$ has the same sign as $\Delta_r H$, an increase in temperature causes ξ_{eq} to decrease: the equilibrium shifts to the left. This is the shift that would reduce the temperature if the reaction were adiabatic.
2. If $\Delta_r V$ is positive, the volume increases as the reaction proceeds to the right at constant T and p . $(\partial \xi_{\text{eq}} / \partial p)_T$ has the opposite sign, so if we increase the pressure isothermally by reducing the volume, the equilibrium shifts to the left. This is the shift that would reduce the pressure if the reaction occurred at constant T and V .

It is easy to misuse or to be misled by Le Châtelier's principle. Consider the solution process $\text{B}^*(\text{s}) \rightarrow \text{B}(\text{soln})$ for which $(\partial \xi_{\text{eq}} / \partial T)_p$, the rate of change of solubility with T , has the same sign as the molar differential enthalpy of solution $\Delta_{\text{sol}} H$ at saturation. The sign of $\Delta_{\text{sol}} H$ at saturation may be different from the sign of the molar *integral* enthalpy of solution, $\Delta H_{\text{m}}(\text{sol})$. This is the situation for the dissolution of sodium acetate shown in Fig. 11.9 on page 327. The equilibrium position (saturation) with one kilogram of water is at $\xi_{\text{sol}} \approx 15$ mol, indicated in the figure by an open circle. At this position, $\Delta_{\text{sol}} H$ is positive and $\Delta H_{\text{m}}(\text{sol})$ is negative. So, despite the fact that the dissolution of 15 moles of sodium

acetate in one kilogram of water to form a saturated solution is an exothermic process, the solubility of sodium acetate actually *increases* with increasing temperature, contrary to what one might predict from Le Châtelier's principle.²³

Another kind of change for which Le Châtelier's principle gives an incorrect prediction is the addition of an inert gas to a gas mixture of constant volume. Adding the inert gas at constant V increases the pressure, but has little effect on the equilibrium position of a gas-phase reaction regardless of the value of $\Delta_r V$. This is because the inert gas affects the activities of the reactants and products only slightly, and not at all if the gas mixture is ideal, so there is little or no effect on the value of Q_{rxn} . (Note that the dependence of ξ_{eq} on p expressed by Eq. 11.9.9 does not apply to an open system.)

The rigorous criterion for the equilibrium position of a reaction is always the requirement that Q_{rxn} must equal K or, equivalently, that $\Delta_r G$ must be zero.

²³Ref. [20].

PROBLEMS

An underlined problem number or problem-part letter indicates that the numerical answer appears in Appendix I.

11.1 Use values of $\Delta_f H^\circ$ and $\Delta_f G^\circ$ in Appendix H to evaluate the standard molar reaction enthalpy and the thermodynamic equilibrium constant at 298.15 K for the oxidation of nitrogen to form aqueous nitric acid:

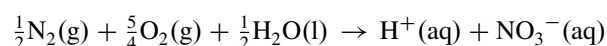

11.2 In 1982, the International Union of Pure and Applied Chemistry recommended that the value of the standard pressure p° be changed from 1 atm to 1 bar. This change affects the values of some standard molar quantities of a substance calculated from experimental data.

- (a) Find the changes in H_m° , S_m° , and G_m° for a gaseous substance when the standard pressure is changed isothermally from 1.01325 bar (1 atm) to exactly 1 bar. (Such a small pressure change has an entirely negligible effect on these quantities for a substance in a condensed phase.)
- (b) What are the values of the corrections that need to be made to the standard molar enthalpy of formation, the standard molar entropy of formation, and the standard molar Gibbs energy of formation of $\text{N}_2\text{O}_4(\text{g})$ at 298.15 K when the standard pressure is changed from 1.01325 bar to 1 bar?

11.3 From data for mercury listed in Appendix H, calculate the saturation vapor pressure of liquid mercury at both 298.15 K and 273.15 K. You may need to make some reasonable approximations.

11.4 Given the following experimental values at $T = 298.15 \text{ K}$, $p = 1 \text{ bar}$:

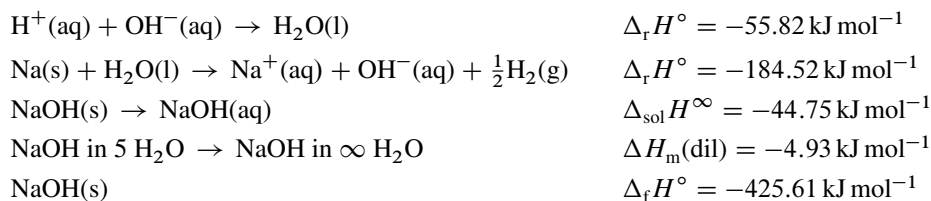

Using only these values, calculate:

- (a) $\Delta_f H^\circ$ for $\text{Na}^+(\text{aq})$, $\text{NaOH}(\text{aq})$, and $\text{OH}^-(\text{aq})$;
- (b) $\Delta_f H$ for NaOH in 5 H_2O ;
- (c) $\Delta H_m(\text{sol})$ for the dissolution of 1 mol $\text{NaOH}(\text{s})$ in 5 mol H_2O .

Table 11.1 Data for Problem 11.5^a

Substance	$\Delta_f H/\text{kJ mol}^{-1}$	$M/\text{g mol}^{-1}$
$\text{H}_2\text{O}(\text{l})$	-285.830	18.0153
$\text{Na}_2\text{S}_2\text{O}_3 \cdot 5\text{H}_2\text{O}(\text{s})$	-2607.93	248.1828
$\text{Na}_2\text{S}_2\text{O}_3$ in 50 H_2O	-1135.914	
$\text{Na}_2\text{S}_2\text{O}_3$ in 100 H_2O	-1133.822	
$\text{Na}_2\text{S}_2\text{O}_3$ in 200 H_2O	-1132.236	
$\text{Na}_2\text{S}_2\text{O}_3$ in 300 H_2O	-1131.780	

^aRef. [177], pages 2-307 and 2-308.

11.5 Table 11.1 lists data for water, crystalline sodium thiosulfate pentahydrate, and several sodium thiosulfate solutions. Find ΔH to the nearest 0.01 kJ for the dissolution of 5.00 g of crystalline $\text{Na}_2\text{S}_2\text{O}_3 \cdot 5\text{H}_2\text{O}$ in 50.0 g of water at 298.15 K and 1 bar.

Table 11.2 Data for Problem 11.6. Molar integral enthalpies of dilution of aqueous HCl ($m'_B = 3.337 \text{ mol kg}^{-1}$) at 25 °C.^a

$m''_B/\text{mol kg}^{-1}$	$\Delta H_m(\text{dil}, m'_B \rightarrow m''_B)/\text{kJ mol}^{-1}$
0.295	-2.883
0.225	-2.999
0.199	-3.041
0.147	-3.143
0.113	-3.217
0.0716	-3.325
0.0544	-3.381
0.0497	-3.412
0.0368	-3.466
0.0179	-3.574
0.0128	-3.621

^aRef. [167].

11.6 Use the experimental data in Table 11.2 to evaluate L_A and L_B at 25 °C for an aqueous HCl solution of molality $m_B = 0.0900 \text{ mol kg}^{-1}$.

Table 11.3 Data for Problem 11.7. The values of intensive properties are for a temperature of 298.15 K and a pressure of 30 bar unless otherwise stated. Subscripts: A = H₂O, B = O₂, C = CO₂.

Properties of the bomb vessel:	
internal volume	350.0 cm ³
mass of <i>n</i> -hexane placed in bomb	0.6741 g
mass of water placed in bomb	1.0016 g
Properties of liquid <i>n</i> -hexane:	
molar mass	$M = 86.177 \text{ g mol}^{-1}$
density	$\rho = 0.6548 \text{ g cm}^{-3}$
cubic expansion coefficient	$\alpha = 1.378 \times 10^{-3} \text{ K}^{-1}$
Properties of liquid H ₂ O:	
molar mass	$M = 18.0153 \text{ g mol}^{-1}$
density	$\rho = 0.9970 \text{ g cm}^{-3}$
cubic expansion coefficient	$\alpha = 2.59 \times 10^{-4} \text{ K}^{-1}$
standard molar energy of vaporization ...	$\Delta_{\text{vap}}U^\circ = 41.53 \text{ kJ mol}^{-1}$
Second virial coefficients, 298.15 K:	
B_{AA}	$-1158 \text{ cm}^3 \text{ mol}^{-1}$
B_{BB}	$-16 \text{ cm}^3 \text{ mol}^{-1}$
$\text{d}B_{BB}/\text{d}T$	$0.21 \text{ cm}^3 \text{ K}^{-1} \text{ mol}^{-1}$
B_{CC}	$-127 \text{ cm}^3 \text{ mol}^{-1}$
$\text{d}B_{CC}/\text{d}T$	$0.97 \text{ cm}^3 \text{ K}^{-1} \text{ mol}^{-1}$
B_{AB}	$-40 \text{ cm}^3 \text{ mol}^{-1}$
B_{AC}	$-214 \text{ cm}^3 \text{ mol}^{-1}$
B_{BC}	$-43.7 \text{ cm}^3 \text{ mol}^{-1}$
$\text{d}B_{BC}/\text{d}T$	$0.4 \text{ cm}^3 \text{ K}^{-1} \text{ mol}^{-1}$
Henry's law constants at 1 bar (solvent = H ₂ O):	
O ₂	$k_{m,B} = 796 \text{ bar kg mol}^{-1}$
CO ₂	$k_{m,C} = 29.7 \text{ bar kg mol}^{-1}$
Partial molar volumes of solutes in water:	
O ₂	$V_B^\infty = 31 \text{ cm}^3 \text{ mol}^{-1}$
CO ₂	$V_C^\infty = 33 \text{ cm}^3 \text{ mol}^{-1}$
Standard molar energies of solution (solvent = H ₂ O):	
O ₂	$\Delta_{\text{sol}}U^\circ = -9.7 \text{ kJ mol}^{-1}$
CO ₂	$\Delta_{\text{sol}}U^\circ = -17.3 \text{ kJ mol}^{-1}$

11.7 This 16-part problem illustrates the use of experimental data from bomb calorimetry and other sources, combined with thermodynamic relations derived in this and earlier chapters, to evaluate the standard molar combustion enthalpy of a liquid hydrocarbon. The substance under investigation is *n*-hexane, and the combustion reaction in the bomb vessel is

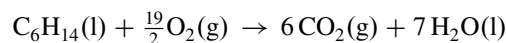

Assume that the sample is placed in a glass ampoule that shatters at ignition. Data needed for this problem are collected in Table 11.3.

States 1 and 2 referred to in this problem are the initial and final states of the isothermal bomb process. The temperature is the reference temperature of 298.15 K.

(a) Parts (a)–(c) consist of simple calculations of some quantities needed in later parts of the problem. Begin by using the masses of C₆H₁₄ and H₂O placed in the bomb vessel, and

their molar masses, to calculate the amounts (moles) of C_6H_{14} and H_2O present initially in the bomb vessel. Then use the stoichiometry of the combustion reaction to find the amount of O_2 consumed and the amounts of H_2O and CO_2 present in state 2. (There is not enough information at this stage to allow you to find the amount of O_2 present, just the change.) Also find the final mass of H_2O . Assume that oxygen is present in excess and the combustion reaction goes to completion.

- (b) From the molar masses and the densities of liquid C_6H_{14} and H_2O , calculate their molar volumes.
- (c) From the amounts present initially in the bomb vessel and the internal volume, find the volumes of liquid C_6H_{14} , liquid H_2O , and gas in state 1 and the volumes of liquid H_2O and gas in state 2. For this calculation, you can neglect the small change in the volume of liquid H_2O due to its vaporization.
- (d) When the bomb vessel is charged with oxygen and before the inlet valve is closed, the pressure at 298.15 K measured on an external gauge is found to be $p_1 = 30.00$ bar. To a good approximation, the gas phase of state 1 has the equation of state of pure O_2 (since the vapor pressure of water is only 0.1 % of 30.00 bar). Assume that this equation of state is given by $V_m = RT/p + B_{BB}$ (Eq. 2.2.8), where B_{BB} is the second virial coefficient of O_2 listed in Table 11.3. Solve for the amount of O_2 in the gas phase of state 1. The gas phase of state 2 is a mixture of O_2 and CO_2 , again with a negligible partial pressure of H_2O . Assume that only small fractions of the total amounts of O_2 and CO_2 dissolve in the liquid water, and find the amount of O_2 in the gas phase of state 2 and the mole fractions of O_2 and CO_2 in this phase.
- (e) You now have the information needed to find the pressure in state 2, which cannot be measured directly. For the mixture of O_2 and CO_2 in the gas phase of state 2, use Eq. 9.3.23 on page 247 to calculate the second virial coefficient. Then solve the equation of state of Eq. 9.3.21 on page 246 for the pressure. Also calculate the partial pressures of the O_2 and CO_2 in the gas mixture.
- (f) Although the amounts of H_2O in the gas phases of states 1 and 2 are small, you need to know their values in order to take the energy of vaporization into account. In this part, you calculate the fugacities of the H_2O in the initial and final gas phases, in part (g) you use gas equations of state to evaluate the fugacity coefficients of the H_2O (as well as of the O_2 and CO_2), and then in part (h) you find the amounts of H_2O in the initial and final gas phases.

The pressure at which the pure liquid and gas phases of H_2O are in equilibrium at 298.15 K (the saturation vapor pressure of water) is 0.03169 bar. Use Eq. 7.8.18 on page 187 to estimate the fugacity of $H_2O(g)$ in equilibrium with pure liquid water at this temperature and pressure. The effect of pressure on fugacity in a one-component liquid–gas system is discussed in Sec. 12.8.1; use Eq. 12.8.3 on page 400 to find the fugacity of H_2O in gas phases equilibrated with liquid water at the pressures of states 1 and 2 of the isothermal bomb process. (The mole fraction of O_2 dissolved in the liquid water is so small that you can ignore its effect on the chemical potential of the water.)

- (g) Calculate the fugacity coefficients of H_2O and O_2 in the gas phase of state 1 and of H_2O , O_2 , and CO_2 in the gas phase of state 2.

For state 1, in which the gas phase is practically-pure O_2 , you can use Eq. 7.8.18 on page 187 to calculate ϕ_{O_2} . The other calculations require Eq. 9.3.29 on page 247, with the value of B'_i found from the formulas of Eq. 9.3.26 or Eqs. 9.3.27 and 9.3.28 (y_A is so small that you can set it equal to zero in these formulas).

Use the fugacity coefficient and partial pressure of O_2 to evaluate its fugacity in states 1 and 2; likewise, find the fugacity of CO_2 in state 2. [You calculated the fugacity of the H_2O in part (f).]

- (h) From the values of the fugacity and fugacity coefficient of a constituent of a gas mixture, you can calculate the partial pressure with Eq. 9.3.17 on page 245, then the mole fraction with $y_i = p_i/p$, and finally the amount with $n_i = y_i n$. Use this method to find the amounts of H₂O in the gas phases of states 1 and 2, and also calculate the amounts of H₂O in the liquid phases of both states.
- (i) Next, consider the O₂ dissolved in the water of state 1 and the O₂ and CO₂ dissolved in the water of state 2. Treat the solutions of these gases as ideal dilute with the molality of solute i given by $m_i = f_i/k_{m,i}$ (Eq. 9.4.21). The values of the Henry's law constants of these gases listed in Table 11.3 are for the standard pressure of 1 bar. Use Eq. 12.8.35 on page 408 to find the appropriate values of $k_{m,i}$ at the pressures of states 1 and 2, and use these values to calculate the amounts of the dissolved gases in both states.
- (j) At this point in the calculations, you know the values of all properties needed to describe the initial and final states of the isothermal bomb process. You are now able to evaluate the various Washburn corrections. These corrections are the internal energy changes, at the reference temperature of 298.15 K, of processes that connect the standard states of substances with either state 1 or state 2 of the isothermal bomb process. First, consider the gaseous H₂O. The Washburn corrections should be based on a pure-liquid standard state for the H₂O. Section 7.9 shows that the molar internal energy of a pure gas under ideal-gas conditions (low pressure) is the same as the molar internal energy of the gas in its standard state at the same temperature. Thus, the molar internal energy change when a substance in its pure-liquid standard state changes isothermally to an ideal gas is equal to the standard molar internal energy of vaporization, $\Delta_{\text{vap}}U^\circ$. Using the value of $\Delta_{\text{vap}}U^\circ$ for H₂O given in Table 11.3, calculate ΔU for the vaporization of liquid H₂O at pressure p° to ideal gas in the amount present in the gas phase of state 1. Also calculate ΔU for the condensation of ideal gaseous H₂O in the amount present in the gas phase of state 2 to liquid at pressure p° .
- (k) Next, consider the dissolved O₂ and CO₂, for which gas standard states are used. Assume that the solutions are sufficiently dilute to have infinite-dilution behavior; then the partial molar internal energy of either solute in the solution at the standard pressure $p^\circ = 1$ bar is equal to the standard partial molar internal energy based on a solute standard state (Sec. 9.7.1). Values of $\Delta_{\text{sol}}U^\circ$ are listed in Table 11.3. Find ΔU for the dissolution of O₂ from its gas standard state to ideal-dilute solution at pressure p° in the amount present in the aqueous phase of state 1. Find ΔU for the desolution (transfer from solution to gas phase) of O₂ and of CO₂ from ideal-dilute solution at pressure p° , in the amounts present in the aqueous phase of state 2, to their gas standard states.
- (l) Calculate the internal energy changes when the liquid phases of state 1 (n -hexane and aqueous solution) are compressed from p° to p_1 and the aqueous solution of state 2 is decompressed from p_2 to p° . Use an approximate expression from Table 7.4, and treat the cubic expansion coefficient of the aqueous solutions as being the same as that of pure water.
- (m) The final Washburn corrections are internal energy changes of the gas phases of states 1 and 2. H₂O has such low mole fractions in these phases that you can ignore H₂O in these calculations; that is, treat the gas phase of state 1 as pure O₂ and the gas phase of state 2 as a binary mixture of O₂ and CO₂. One of the internal energy changes is for the compression of gaseous O₂, starting at a pressure low enough for ideal-gas behavior ($U_m = U_m^\circ$) and ending at pressure p_1 to form the gas phase present in state 1. Use the approximate expression for $U_m - U_m^\circ(\text{g})$ in Table 7.5 to calculate $\Delta U = U(p_1) - nU_m^\circ(\text{g})$; a value of dB/dT for pure O₂ is listed in Table 11.3. The other internal energy change is for a process in which the gas phase of state 2 at pressure p_2 is expanded until the pressure is low enough for the gas to behave ideally,

and the mixture is then separated into ideal-gas phases of pure O₂ and CO₂. The molar internal energies of the separated low-pressure O₂ and CO₂ gases are the same as the standard molar internal energies of these gases. The internal energy of unmixing ideal gases is zero (Eq. 11.1.11). The dependence of the internal energy of the gas mixture is given, to a good approximation, by $U = \sum_i U_i^\circ(\text{g}) - npT \, dB/dT$, where B is the second virial coefficient of the gas mixture; this expression is the analogy for a gas mixture of the approximate expression for $U_m - U_m^\circ(\text{g})$ in Table 7.5. Calculate the value of dB/dT for the mixture of O₂ and CO₂ in state 2 (you need Eq. 9.3.23 on page 247 and the values of dB_{ij}/dT in Table 11.3) and evaluate $\Delta U = \sum_i n_i U_i^\circ(\text{g}) - U(p_2)$ for the gas expansion.

- (n) Add the internal energy changes you calculated in parts (j)–(m) to find the total internal energy change of the Washburn corrections. Note that most of the corrections occur in pairs of opposite sign and almost completely cancel one another. Which contributions are the greatest in magnitude?
- (o) The internal energy change of the isothermal bomb process in the bomb vessel, corrected to the reference temperature of 298.15 K, is found to be $\Delta U(\text{IBP}, T_{\text{ref}}) = -32.504 \text{ kJ}$. Assume there are no side reactions or auxiliary reactions. From Eqs. 11.5.9 and 11.5.10, calculate the standard molar internal energy of combustion of n -hexane at 298.15 K.
- (p) From Eq. 11.5.13, calculate the standard molar enthalpy of combustion of n -hexane at 298.15 K.

11.8 By combining the results of Prob. 11.7(p) with the values of standard molar enthalpies of formation from Appendix H, calculate the standard molar enthalpy of formation of liquid n -hexane at 298.15 K.

11.9 Consider the combustion of methane:

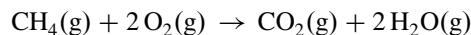

Suppose the reaction occurs in a flowing gas mixture of methane and air. Assume that the pressure is constant at 1 bar, the reactant mixture is at a temperature of 298.15 K and has stoichiometric proportions of methane and oxygen, and the reaction goes to completion with no dissociation. For the quantity of gaseous product mixture containing 1 mol CO₂, 2 mol H₂O, and the nitrogen and other substances remaining from the air, you may use the approximate formula $C_p(\text{P}) = a + bT$, where the coefficients have the values $a = 297.0 \text{ J K}^{-1}$ and $b = 8.520 \times 10^{-2} \text{ J K}^{-2}$. Solve Eq. 11.6.1 for T_2 to estimate the flame temperature to the nearest kelvin.

11.10 The standard molar Gibbs energy of formation of crystalline mercury(II) oxide at 600.00 K has the value $\Delta_f G^\circ = -26.386 \text{ kJ mol}^{-1}$. Estimate the partial pressure of O₂ in equilibrium with HgO at this temperature: $2 \text{HgO}(\text{s}) \rightleftharpoons 2 \text{Hg}(\text{l}) + \text{O}_2(\text{g})$.

11.11 The combustion of hydrogen is a reaction that is known to “go to completion.”

- (a) Use data in Appendix H to evaluate the thermodynamic equilibrium constant at 298.15 K for the reaction

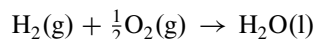

- (b) Assume that the reaction is at equilibrium at 298.15 K in a system in which the partial pressure of O₂ is 1.0 bar. Assume ideal-gas behavior and find the equilibrium partial pressure of H₂ and the number of H₂ molecules in 1.0 m³ of the gas phase.
- (c) In the preceding part, you calculated a very small value (a fraction) for the number of H₂ molecules in 1.0 m³. Statistically, this fraction can be interpreted as the fraction of a given length of time during which one molecule is present in the system. Take the age of the

universe as 1.0×10^{10} years and find the total length of time in seconds, during the age of the universe, that a H_2 molecule is present in the equilibrium system. (This hypothetical value is a dramatic demonstration of the statement that the limiting reactant is essentially entirely exhausted during a reaction with a large value of K .)

- 11.12** Let G represent carbon in the form of *graphite* and D represent the *diamond* crystal form. At 298.15 K, the thermodynamic equilibrium constant for $\text{G} \rightleftharpoons \text{D}$, based on a standard pressure $p^\circ = 1 \text{ bar}$, has the value $K = 0.31$. The molar volumes of the two crystal forms at this temperature are $V_m(\text{G}) = 5.3 \times 10^{-6} \text{ m}^3 \text{ mol}^{-1}$ and $V_m(\text{D}) = 3.4 \times 10^{-6} \text{ m}^3 \text{ mol}^{-1}$.
- Write an expression for the reaction quotient Q_{rxn} as a function of pressure. Use the approximate expression of the pressure factor given in Table 9.6.
 - Use the value of K to estimate the pressure at which the D and G crystal forms are in equilibrium with one another at 298.15 K. (This is the lowest pressure at which graphite could in principle be converted to diamond at this temperature.)
- 11.13** Consider the dissociation reaction $\text{N}_2\text{O}_4(\text{g}) \rightarrow 2\text{NO}_2(\text{g})$ taking place at a constant temperature of 298.15 K and a constant pressure of 0.0500 bar. Initially (at $\xi = 0$) the system contains 1.000 mol of N_2O_4 and no NO_2 . Other needed data are found in Appendix H. Assume ideal-gas behavior.
- For values of the advancement ξ ranging from 0 to 1 mol, at an interval of 0.1 mol or less, calculate $[G(\xi) - G(0)]$ to the nearest 0.01 kJ. A computer spreadsheet would be a convenient way to make the calculations.
 - Plot your values of $G(\xi) - G(0)$ as a function of ξ , and draw a smooth curve through the points.
 - On your curve, indicate the estimated position of ξ_{eq} . Calculate the activities of N_2O_4 and NO_2 for this value of ξ , use them to estimate the thermodynamic equilibrium constant K , and compare your result with the value of K calculated from Eq. 11.8.11.

EQUILIBRIUM CONDITIONS IN MULTICOMPONENT SYSTEMS

This chapter applies equilibrium theory to a variety of chemical systems of more than one component. Two different approaches will be used as appropriate: one based on the relation $\mu_i^\alpha = \mu_i^\beta$ for transfer equilibrium, the other based on $\sum_i \nu_i \mu_i = 0$ or $K = \prod_i a_i^{\nu_i}$ for reaction equilibrium.

12.1 Effects of Temperature

For some of the derivations in this chapter, we will need an expression for the rate at which the ratio μ_i/T varies with temperature in a phase of fixed composition maintained at constant pressure. This expression leads, among other things, to an important relation between the temperature dependence of an equilibrium constant and the standard molar reaction enthalpy.

12.1.1 Variation of μ_i/T with temperature

In a phase containing species i , either pure or in a mixture, the partial derivative of μ_i/T with respect to T at constant p and a fixed amount of each species is given by¹

$$\left[\frac{\partial (\mu_i/T)}{\partial T} \right]_{p, \{n_i\}} = \frac{1}{T} \left(\frac{\partial \mu_i}{\partial T} \right)_{p, \{n_i\}} - \frac{\mu_i}{T^2} \quad (12.1.1)$$

This equality comes from a purely mathematical operation; no thermodynamics is involved. The partial derivative $(\partial \mu_i / \partial T)_{p, \{n_i\}}$ is equal to $-S_i$ (Eq. 9.2.48), so that Eq. 12.1.1 becomes

$$\left[\frac{\partial (\mu_i/T)}{\partial T} \right]_{p, \{n_i\}} = -\frac{S_i}{T} - \frac{\mu_i}{T^2} = -\frac{TS_i + \mu_i}{T^2} \quad (12.1.2)$$

The further substitution $\mu_i = H_i - TS_i$ (Eq. 9.2.46) gives finally

$$\left[\frac{\partial (\mu_i/T)}{\partial T} \right]_{p, \{n_i\}} = -\frac{H_i}{T^2} \quad (12.1.3)$$

¹This relation is obtained from the formula $d(uv)/dx = u(dv/dx) + v(du/dx)$ (Appendix E), where u is $1/T$, v is μ_i , and x is T .

For a pure substance in a closed system, Eq. 12.1.3 when multiplied by the amount n becomes

$$\left[\frac{\partial (G/T)}{\partial T} \right]_p = -\frac{H}{T^2} \quad (12.1.4)$$

This is the *Gibbs–Helmholtz equation*.

12.1.2 Variation of μ_i°/T with temperature

If we make the substitution $\mu_i = \mu_i^\circ + RT \ln a_i$ in Eq. 12.1.3 and rearrange, we obtain

$$\frac{d(\mu_i^\circ/T)}{dT} = -\frac{H_i}{T^2} - R \left(\frac{\partial \ln a_i}{\partial T} \right)_{p, \{n_i\}} \quad (12.1.5)$$

Because μ_i°/T is a function only of T , its derivative with respect to T is itself a function only of T . We can therefore use any convenient combination of pressure and composition in the expression on the right side of Eq. 12.1.5 in order to evaluate $d(\mu_i^\circ/T)/dT$ at a given temperature.

If species i is a constituent of a gas mixture, we take a constant pressure of the gas that is low enough for the gas to behave ideally. Under these conditions H_i is the standard molar enthalpy H_i° (Eq. 9.3.7). In the expression for activity, $a_i(\text{g}) = \Gamma_i(\text{g}) \phi_i p_i/p$ (Table 9.5), the pressure factor $\Gamma_i(\text{g})$ is constant when p is constant, the fugacity coefficient ϕ_i for the ideal gas is unity, and $p_i/p = y_i$ is constant at constant $\{n_i\}$, so that the partial derivative $[\partial \ln a_i(\text{g})/\partial T]_{p, \{n_i\}}$ is zero.

For component i of a condensed-phase mixture, we take a constant pressure equal to the standard pressure p° , and a mixture composition in the limit given by Eqs. 9.5.20–9.5.24 in which the activity coefficient is unity. H_i is then the standard molar enthalpy H_i° , and the activity is given by an expression in Table 9.5 with the pressure factor and activity coefficient set equal to 1: $a_i = x_i$, $a_A = x_A$, $a_{x,B} = x_B$, $a_{c,B} = c_B/c^\circ$, or $a_{m,B} = m_B/m^\circ$.² With the exception of $a_{c,B}$, these activities are constant as T changes at constant p and $\{n_i\}$.

Thus for a gas-phase species, or a species with a standard state based on mole fraction or molality, $[\partial \ln a_i(\text{g})/\partial T]_{p, \{n_i\}}$ is zero and Eq. 12.1.5 becomes

$$\frac{d(\mu_i^\circ/T)}{dT} = -\frac{H_i^\circ}{T^2} \quad (12.1.6)$$

(standard state not based on concentration)

Equation 12.1.6, as the conditions of validity indicate, does not apply to a solute standard state based on concentration, except as an approximation. The reason is the volume change that accompanies an isobaric temperature change. We can treat this case by considering the following behavior of $\ln(c_B/c^\circ)$:

$$\begin{aligned} \left[\frac{\partial \ln(c_B/c^\circ)}{\partial T} \right]_{p, \{n_i\}} &= \frac{1}{c_B} \left(\frac{\partial c_B}{\partial T} \right)_{p, \{n_i\}} = \frac{1}{n_B/V} \left[\frac{\partial (n_B/V)}{\partial T} \right]_{p, \{n_i\}} \\ &= V \left[\frac{\partial (1/V)}{\partial T} \right]_{p, \{n_i\}} = -\frac{1}{V} \left(\frac{\partial V}{\partial T} \right)_{p, \{n_i\}} \\ &= -\alpha \end{aligned} \quad (12.1.7)$$

²If solute B is an electrolyte, $a_{m,B}$ is given instead by Eq. 10.3.10; like $a_{m,B}$ for a nonelectrolyte, it is constant as T changes at constant p and $\{n_i\}$.

Here α is the cubic expansion coefficient of the solution (Eq. 7.1.1). If the activity coefficient is to be unity, the solution must be an ideal-dilute solution, and α is then α_A^* , the cubic expansion coefficient of the pure solvent. Eq. 12.1.5 for a nonelectrolyte becomes

$$\frac{d(\mu_{c,B}^\circ/T)}{dT} = -\frac{H_B^\circ}{T^2} + R\alpha_A^* \quad (12.1.8)$$

12.1.3 Variation of $\ln K$ with temperature

The thermodynamic equilibrium constant K , for a given reaction equation and a given choice of reactant and product standard states, is a function of T and *only* of T . By equating two expressions for the standard molar reaction Gibbs energy, $\Delta_r G^\circ = \sum_i \nu_i \mu_i^\circ$ and $\Delta_r G^\circ = -RT \ln K$ (Eqs. 11.8.3 and 11.8.10), we obtain

$$\ln K = -\frac{1}{RT} \sum_i \nu_i \mu_i^\circ \quad (12.1.9)$$

The rate at which $\ln K$ varies with T is then given by

$$\frac{d \ln K}{dT} = -\frac{1}{R} \sum_i \nu_i \frac{d(\mu_i^\circ/T)}{dT} \quad (12.1.10)$$

Combining Eq. 12.1.10 with Eqs. 12.1.6 or 12.1.8, and recognizing that $\sum_i \nu_i H_i^\circ$ is the standard molar reaction enthalpy $\Delta_r H^\circ$, we obtain the final expression for the temperature dependence of $\ln K$:

$$\frac{d \ln K}{dT} = \frac{\Delta_r H^\circ}{RT^2} - \alpha_A^* \sum_{\substack{\text{solute,} \\ \text{conc. basis}}} \nu_i \quad (12.1.11)$$

The sum on the right side includes only solute species whose standard states are based on concentration. The expression is simpler if all solute standard states are based on mole fraction or molality:

$$\frac{d \ln K}{dT} = \frac{\Delta_r H^\circ}{RT^2} \quad (12.1.12)$$

(no solute standard states based on concentration)

We can rearrange Eq. 12.1.12 to

$$\Delta_r H^\circ = RT^2 \frac{d \ln K}{dT} \quad (12.1.13)$$

(no solute standard states based on concentration)

We can convert this expression for $\Delta_r H^\circ$ to an equivalent form by using the mathematical identity $d(1/T) = -(1/T^2) dT$:

$$\Delta_r H^\circ = -R \frac{d \ln K}{d(1/T)} \quad (12.1.14)$$

(no solute standard states based on concentration)

Table 12.1 Comparison of the Clausius–Clapeyron and van’t Hoff equations for vaporization of a liquid.

Clausius–Clapeyron equation	van’t Hoff equation
$\Delta_{\text{vap}}H \approx -R \frac{d \ln(p/p^\circ)}{d(1/T)}$	$\Delta_{\text{vap}}H^\circ = -R \frac{d \ln K}{d(1/T)}$
Derivation assumes $V_m(\text{g}) \gg V_m(\text{l})$ and ideal-gas behavior.	An exact relation.
$\Delta_{\text{vap}}H$ is the difference of the molar enthalpies of the real gas and the liquid at the saturation vapor pressure of the liquid.	$\Delta_{\text{vap}}H^\circ$ is the difference of the molar enthalpies of the ideal gas and the liquid at pressure p° .
p is the saturation vapor pressure of the liquid.	K is equal to $a(\text{g})/a(\text{l}) = (f/p^\circ)/\Gamma(\text{l})$, and is only approximately equal to p/p° .

Equations 12.1.13 and 12.1.14 are two forms of the **van’t Hoff equation**. They allow us to evaluate the standard molar reaction enthalpy of a reaction by a noncalorimetric method from the temperature dependence of $\ln K$. For example, we can plot $\ln K$ versus $1/T$; then according to Eq. 12.1.14, the slope of the curve at any value of $1/T$ is equal to $-\Delta_r H^\circ/R$ at the corresponding temperature T .

A simple way to derive the equation for this last procedure is to substitute $\Delta_r G^\circ = \Delta_r H^\circ - T\Delta_r S^\circ$ in $\Delta_r G^\circ = -RT \ln K$ and rearrange to

$$\ln K = -\frac{\Delta_r H^\circ}{R} \left(\frac{1}{T} \right) + \frac{\Delta_r S^\circ}{R} \quad (12.1.15)$$

Suppose we plot $\ln K$ versus $1/T$. In a small temperature interval in which $\Delta_r H^\circ$ and $\Delta_r S^\circ$ are practically constant, the curve will appear linear. According to Eq. 12.1.15, the curve in this interval has a slope of $-\Delta_r H^\circ/R$, and the tangent to a point on the curve has its intercept at $1/T=0$ equal to $\Delta_r S^\circ/R$.

When we apply Eq. 12.1.14 to the *vaporization process* $A(\text{l}) \rightarrow A(\text{g})$ of pure A, it resembles the Clausius–Clapeyron equation for the same process (Eq. 8.4.15 on page 221). These equations are not exactly equivalent, however, as the comparison in Table 12.1 shows.

12.2 Solvent Chemical Potentials from Phase Equilibria

Section 9.6.3 explained how we can evaluate the activity coefficient $\gamma_{m,B}$ of a nonelectrolyte solute of a binary solution if we know the variation of the osmotic coefficient of the solution from infinite dilution to the molality of interest. A similar procedure for the mean ionic activity coefficient of an electrolyte solute was described in Sec. 10.6.

The physical measurements needed to find the osmotic coefficient ϕ_m of a binary solution must be directed to the calculation of the quantity $\mu_A^* - \mu_A$, the difference between the chemical potentials of the pure solvent and the solvent in the solution at the temperature and pressure of interest. This difference is positive, because the presence of the solute reduces the solvent’s chemical potential.

To calculate ϕ_m from $\mu_A^* - \mu_A$, we use Eq. 9.6.16 on page 269 for a nonelectrolyte solute, or Eq. 10.6.1 on page 301 for an electrolyte solute. Both equations are represented by

$$\phi_m = \frac{\mu_A^* - \mu_A}{RTM_A \nu m_B} \quad (12.2.1)$$

where ν for a nonelectrolyte is 1 and for an electrolyte is the number of ions per formula unit.

The sequence of steps, then, is (1) the determination of $\mu_A^* - \mu_A$ over a range of molality at constant T and p , (2) the conversion of these values to ϕ_m using Eq. 12.2.1, and (3) the evaluation of the solute activity coefficient³ by a suitable integration from infinite dilution to the molality of interest.

Sections 12.2.1 and 12.2.2 will describe freezing-point and osmotic-pressure measurements, two much-used methods for evaluating $\mu_A^* - \mu_A$ in a binary solution at a given T and p . The isopiestic vapor-pressure method was described in Sec. 9.6.4. The freezing-point and isopiestic vapor-pressure methods are often used for electrolyte solutions, and osmotic pressure is especially useful for solutions of macromolecules.

12.2.1 Freezing-point measurements

This section explains how we can evaluate $\mu_A^* - \mu_A$ for a solution of a given composition at a given T and p from the freezing point of the solution combined with additional data obtained from calorimetric measurements.

Consider a binary solution of solvent A and solute B. We assume that when this solution is cooled at constant pressure and composition, the solid that first appears is pure A. For example, for a dilute aqueous solution the solid would be ice. The temperature at which solid A first appears is T_f , the freezing point of the solution. This temperature is lower than the freezing point T_f^* of the pure solvent, a consequence of the lowering of μ_A by the presence of the solute. Both T_f and T_f^* can be measured experimentally.

Let T' be a temperature of interest that is equal to or greater than T_f^* . We wish to determine the value of $\mu_A^*(l, T') - \mu_A(\text{sln}, T')$, where $\mu_A^*(l, T')$ refers to pure liquid solvent and $\mu_A(\text{sln}, T')$ refers to the solution.

Figure 12.1 on the next page explains the principle of the procedure. The figure shows μ_A/T for the solvent in the pure solid phase, in the pure liquid phase, and in the fixed-composition solution, plotted as functions of T at constant p . Since μ_A is the same in the solution and solid phases at temperature T_f , and is the same in the pure liquid and solid phases at temperature T_f^* , the curves intersect at these temperatures as shown.

Formulas for the slopes of the three curves, from Eq. 12.1.3 on page 367, are included in the figure. The desired value of $\mu_A^*(l, T') - \mu_A(\text{sln}, T')$ is the product of T' and the difference of the values of μ_A/T at points e and a. To find this difference, we integrate the slope $d(\mu_A/T)/dT$ over T along the path abcde:

$$\begin{aligned} \frac{\mu_A^*(l, T')}{T'} - \frac{\mu_A(\text{sln}, T')}{T'} &= - \int_{T'}^{T_f^*} \frac{H_A(\text{sln})}{T^2} dT - \int_{T_f^*}^{T_f} \frac{H_A(\text{sln})}{T^2} dT \\ &\quad - \int_{T_f}^{T_f^*} \frac{H_A^*(s)}{T^2} dT - \int_{T_f^*}^{T'} \frac{H_A^*(l)}{T^2} dT \end{aligned} \quad (12.2.2)$$

³A measurement of $\mu_A^* - \mu_A$ also gives us the *solvent* activity coefficient, based on the pure-solvent reference state, through the relation $\mu_A = \mu_A^* + RT \ln(\gamma_A x_A)$ (Eq. 9.5.15).

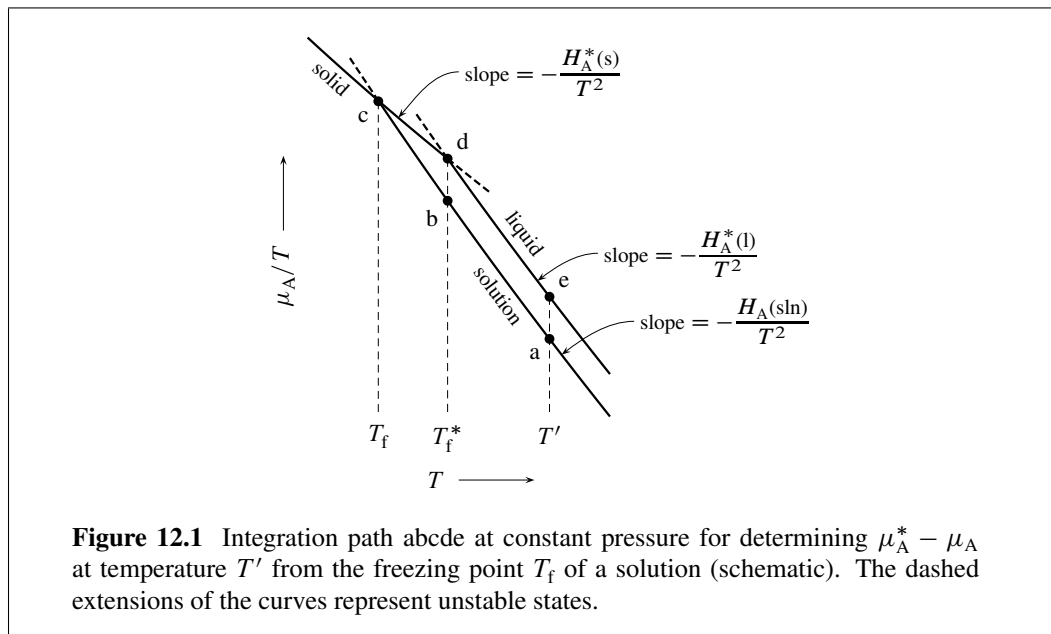

Figure 12.1 Integration path abcde at constant pressure for determining $\mu_A^* - \mu_A$ at temperature T' from the freezing point T_f of a solution (schematic). The dashed extensions of the curves represent unstable states.

By combining integrals that have the same range of integration, we turn Eq. 12.2.2 into

$$\begin{aligned} \frac{\mu_A^*(l, T')}{T'} - \frac{\mu_A(\text{sln}, T')}{T'} &= \int_{T_f}^{T_f^*} \frac{H_A(\text{sln}) - H_A^*(s)}{T^2} dT \\ &+ \int_{T_f^*}^{T'} \frac{H_A(\text{sln}) - H_A^*(l)}{T^2} dT \end{aligned} \quad (12.2.3)$$

For convenience of notation, this book will use $\Delta_{\text{sol},A}H$ to denote the molar enthalpy difference $H_A(\text{sln}) - H_A^*(s)$. $\Delta_{\text{sol},A}H$ is the molar differential enthalpy of solution of solid A in the solution at constant T and p . The first integral on the right side of Eq. 12.2.3 requires knowledge of $\Delta_{\text{sol},A}H$ over a temperature range, but the only temperature at which it is practical to measure this quantity calorimetrically is at the equilibrium transition temperature T_f . It is usually sufficient to assume $\Delta_{\text{sol},A}H$ is a linear function of T :

$$\Delta_{\text{sol},A}H(T) = \Delta_{\text{sol},A}H(T_f) + \Delta_{\text{sol},A}C_p(T - T_f) \quad (12.2.4)$$

The molar differential heat capacity of solution $\Delta_{\text{sol},A}C_p = C_{p,A}(\text{sln}) - C_{p,A}(s)$ is treated as a constant that can be determined from calorimetric measurements.

The quantity $H_A(\text{sln}) - H_A^*(l)$ in the second integral on the right side of Eq. 12.2.3 is the molar differential enthalpy of dilution of the solvent in the solution, $\Delta_{\text{dil}}H$ (see Eq. 11.4.7). This quantity can be measured calorimetrically at any temperature higher than T_f^* . Making this substitution in Eq. 12.2.3 together with that of Eq. 12.2.4, carrying out the integration of the first integral and rearranging, we obtain finally

$$\begin{aligned} \mu_A^*(l, T') - \mu_A(\text{sln}, T') &= T' \left[\Delta_{\text{sol},A}H(T_f) - T_f \Delta_{\text{sol},A}C_p \right] \left(\frac{1}{T_f} - \frac{1}{T_f^*} \right) \\ &+ T' \Delta_{\text{sol},A}C_p \ln \frac{T_f^*}{T_f} + T' \int_{T_f^*}^{T'} \frac{\Delta_{\text{dil}}H}{T^2} dT \end{aligned} \quad (12.2.5)$$

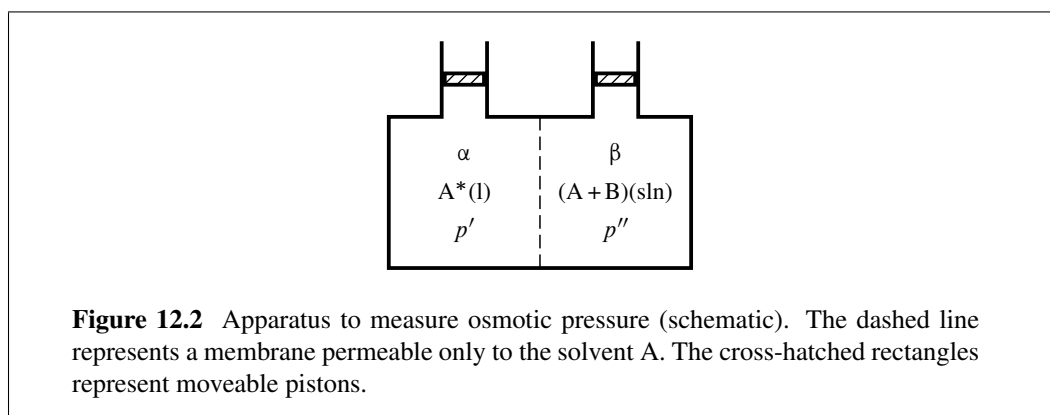

Figure 12.2 Apparatus to measure osmotic pressure (schematic). The dashed line represents a membrane permeable only to the solvent A. The cross-hatched rectangles represent moveable pistons.

12.2.2 Osmotic-pressure measurements

A second method for evaluating $\mu_A^* - \mu_A$ uses the solution property called *osmotic pressure*. A simple apparatus to measure the osmotic pressure of a binary solution is shown schematically in Fig. 12.2. The system consists of two liquid phases separated by a semipermeable membrane. Phase α is pure solvent and phase β is a solution with the same solvent at the same temperature. The semipermeable membrane is permeable to the solvent and impermeable to the solute.

The presence of the membrane makes this system different from the multiphase, multicomponent system of Sec. 9.2.7, used there to derive conditions for transfer equilibrium. By a modification of that procedure, we can derive the conditions of equilibrium for the present system. We take phase β as the reference phase because it includes both solvent and solute. In order to prevent expansion work in the isolated system, both pistons shown in the figure must be fixed in stationary positions. This keeps the volume of each phase constant: $dV^\alpha = dV^\beta = 0$. Equation 9.2.41 on page 239, expressing the total differential of the entropy in an isolated multiphase, multicomponent system, becomes

$$dS = \frac{T^\beta - T^\alpha}{T^\beta} dS^\alpha + \frac{\mu_A^\beta - \mu_A^\alpha}{T^\beta} dn_A^\alpha \quad (12.2.6)$$

In an equilibrium state, the coefficients $(T^\beta - T^\alpha)/T^\beta$ and $(\mu_A^\beta - \mu_A^\alpha)/T^\beta$ must be zero. Therefore, in an equilibrium state the temperature is the same in both phases and the solvent has the same chemical potential in both phases. The presence of the membrane, however, allows the pressures of the two phases to be unequal in the equilibrium state.

Suppose we start with both phases shown in Fig. 12.2 at the same temperature and pressure. Under these conditions, the value of μ_A is less in the solution than in the pure liquid, and a spontaneous flow of solvent will occur through the membrane from the pure solvent to the solution. This phenomenon is called *osmosis*.⁴ If we move the right-hand piston down slightly in order to increase the pressure p'' of the solution in phase β , μ_A increases in this phase. The **osmotic pressure** of the solution, Π , is defined as the additional pressure the solution must have, compared to the pressure p' of the pure solvent at the same temperature, to establish an equilibrium state with no flow of solvent in either direction through the membrane: $p'' = p' + \Pi$.

⁴Greek for *push*.

In practice, the membrane may not be completely impermeable to a solute. All that is required for the establishment of an equilibrium state with different pressures on either side of the membrane is that solvent transfer equilibrium be established on a short time scale compared to the period of observation, and that the amount of solute transferred during this period be negligible.

The osmotic pressure Π is an intensive property of a solution whose value depends on the solution's temperature, pressure, and composition. Strictly speaking, Π in an equilibrium state of the system shown in Fig. 12.2 refers to the osmotic pressure of the solution at pressure p' , the pressure of the pure solvent. In other words, the osmotic pressure of a solution at temperature T and pressure p' is the additional pressure that would have to be exerted on the solution to establish transfer equilibrium with pure solvent that has temperature T and pressure p' . A solution has the property called osmotic pressure regardless of whether this additional pressure is actually present, just as a solution has a freezing point even when its actual temperature is different from the freezing point.

Because in an equilibrium state the solvent chemical potential must be the same on both sides of the semipermeable membrane, there is a relation between chemical potentials and osmotic pressure given by

$$\mu_A(p'') = \mu_A(p' + \Pi) = \mu_A^*(p') \quad (12.2.7)$$

(equilibrium state)

We can use this relation to derive an expression for $\mu_A^*(p') - \mu_A(p')$ as a function of Π . The dependence of μ_A on pressure is given according to Eq. 9.2.49 by

$$\left(\frac{\partial \mu_A}{\partial p}\right)_{T, \{n_i\}} = V_A \quad (12.2.8)$$

where V_A is the partial molar volume of the solvent in the solution. Rewriting this equation in the form $d\mu_A = V_A dp$ and integrating at constant temperature and composition from p' to $p' + \Pi$, we obtain

$$\mu_A(p' + \Pi) - \mu_A(p') = \int_{p'}^{p'+\Pi} V_A dp \quad (12.2.9)$$

Substitution from Eq. 12.2.7 changes this to

$$\mu_A^*(p') - \mu_A(p') = \int_{p'}^{p'+\Pi} V_A dp \quad (12.2.10)$$

(constant T)

which is the desired expression for $\mu_A^* - \mu_A$ at a single temperature and pressure. To evaluate the integral, we need an experimental value of the osmotic pressure Π of the solution. If we assume V_A is constant in the pressure range from p' to $p' + \Pi$, Eq. 12.2.10 becomes simply

$$\mu_A^*(p') - \mu_A(p') = V_A \Pi \quad (12.2.11)$$

12.3 Binary Mixture in Equilibrium with a Pure Phase

This section considers a binary liquid mixture of components A and B in equilibrium with either pure solid A or pure gaseous A. The aim is to find general relations among changes of temperature, pressure, and mixture composition in the two-phase equilibrium system that can be applied to specific situations in later sections.

In this section, μ_A is the chemical potential of component A in the mixture and μ_A^* is for the pure solid or gaseous phase. We begin by writing the total differential of μ_A/T with T , p , and x_A as the independent variables. These quantities refer to the binary liquid mixture, and we have not yet imposed a condition of equilibrium with another phase. The general expression for the total differential is

$$d(\mu_A/T) = \left[\frac{\partial(\mu_A/T)}{\partial T} \right]_{p, x_A} dT + \left[\frac{\partial(\mu_A/T)}{\partial p} \right]_{T, x_A} dp + \left[\frac{\partial(\mu_A/T)}{\partial x_A} \right]_{T, p} dx_A \quad (12.3.1)$$

With substitutions from Eqs. 9.2.49 and 12.1.3, this becomes

$$d(\mu_A/T) = -\frac{H_A}{T^2} dT + \frac{V_A}{T} dp + \left[\frac{\partial(\mu_A/T)}{\partial x_A} \right]_{T, p} dx_A \quad (12.3.2)$$

Next we write the total differential of μ_A^*/T for pure solid or gaseous A. The independent variables are T and p ; the expression is like Eq. 12.3.2 with the last term missing:

$$d(\mu_A^*/T) = -\frac{H_A^*}{T^2} dT + \frac{V_A^*}{T} dp \quad (12.3.3)$$

When the two phases are in transfer equilibrium, μ_A and μ_A^* are equal. If changes occur in T , p , or x_A while the phases remain in equilibrium, the condition $d(\mu_A/T) = d(\mu_A^*/T)$ must be satisfied. Equating the expressions on the right sides of Eqs. 12.3.2 and 12.3.3 and combining terms, we obtain the equation

$$\frac{H_A - H_A^*}{T^2} dT - \frac{V_A - V_A^*}{T} dp = \left[\frac{\partial(\mu_A/T)}{\partial x_A} \right]_{T, p} dx_A \quad (12.3.4)$$

which we can rewrite as

$$\frac{\Delta_{\text{sol},A} H}{T^2} dT - \frac{\Delta_{\text{sol},A} V}{T} dp = \left[\frac{\partial(\mu_A/T)}{\partial x_A} \right]_{T, p} dx_A \quad (12.3.5)$$

(phases in equilibrium)

Here $\Delta_{\text{sol},A} H$ is the molar differential enthalpy of solution of solid or gaseous A in the liquid mixture, and $\Delta_{\text{sol},A} V$ is the molar differential volume of solution. Equation 12.3.5 is a relation between changes in the variables T , p , and x_A , only two of which are independent in the equilibrium system.

Suppose we set dp equal to zero in Eq. 12.3.5 and solve for dT/dx_A . This gives us the rate at which T changes with x_A at constant p :

$$\left(\frac{\partial T}{\partial x_A} \right)_p = \frac{T^2}{\Delta_{\text{sol},A} H} \left[\frac{\partial(\mu_A/T)}{\partial x_A} \right]_{T, p} \quad (12.3.6)$$

(phases in equilibrium)

We can also set dT equal to zero in Eq. 12.3.5 and find the rate at which p changes with x_A at constant T :

$$\left(\frac{\partial p}{\partial x_A}\right)_T = -\frac{T}{\Delta_{\text{sol,A}}V} \left[\frac{\partial(\mu_A/T)}{\partial x_A}\right]_{T,p} \quad (12.3.7)$$

(phases in equilibrium)

Equations 12.3.6 and 12.3.7 will be needed in Secs. 12.4 and 12.5.

12.4 Colligative Properties of a Dilute Solution

The **colligative properties** of a solution are usually considered to be:

1. *Freezing-point depression*: the decrease in the freezing point of the solution, compared to pure solvent at the same pressure.
2. *Boiling-point elevation*: the increase in the boiling point of a solution containing nonvolatile solutes, compared to pure solvent at the same pressure.
3. *Vapor-pressure lowering*: the decrease in the vapor pressure of a solution containing nonvolatile solutes, compared to the vapor pressure of the pure solvent at the same temperature.
4. *Osmotic pressure*: the increase in the pressure of the solution that places the solvent in transfer equilibrium with pure solvent at the same temperature and pressure as the original solution (page 374).

Note that all four properties are defined by an equilibrium between the liquid solution and a solid, liquid, or gas phase of the pure solvent. The properties called colligative (Latin: *tied together*) have in common a dependence on the concentration of solute particles that affects the solvent chemical potential.

Figure 12.3 on the next page illustrates the freezing-point depression and boiling-point elevation of an aqueous solution. At a fixed pressure, pure liquid water is in equilibrium with ice at the freezing point and with steam at the boiling point. These are the temperatures at which H_2O has the same chemical potential in both phases at this pressure. At these temperatures, the chemical potential curves for the phases intersect, as indicated by open circles in the figure. The presence of dissolved solute in the solution causes a lowering of the H_2O chemical potential compared to pure water at the same temperature. Consequently, the curve for the chemical potential of H_2O in the solution intersects the curve for ice at a lower temperature, and the curve for steam at a higher temperature, as indicated by open triangles. The freezing point is depressed by ΔT_f , and the boiling point (if the solute is nonvolatile) is elevated by ΔT_b .

Sections 12.4.1–12.4.4 will derive theoretical relations between each of the four colligative properties and solute composition variables in the limit of infinite dilution. The expressions show that the colligative properties of a dilute binary solution depend on properties of the solvent, are proportional to the solute concentration and molality, but do not depend on the kind of solute.

Although these expressions provide no information about the activity coefficient of a solute, they are useful for estimating the solute molar mass. For example, from a measurement of any of the colligative properties of a dilute solution and the appropriate theoretical relation, we can obtain an approximate value of the solute molality m_B . (It is only approximate because, for a measurement of reasonable precision, the solution cannot be extremely

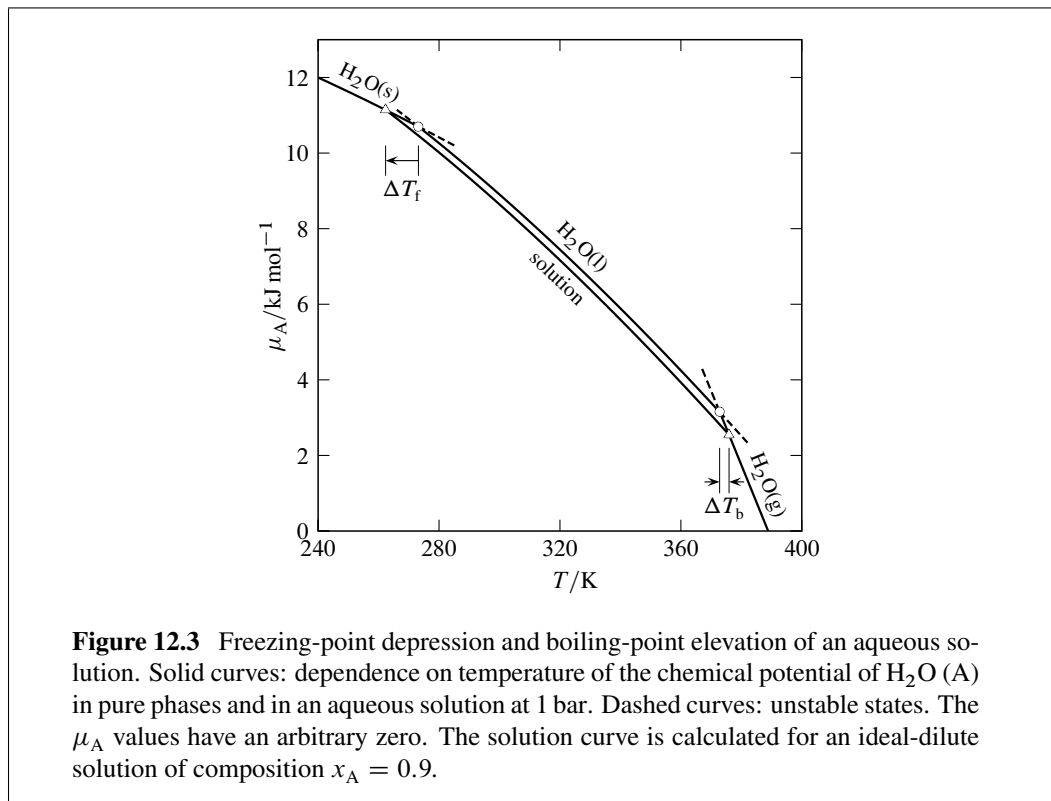

dilute.) If we prepare the solution with a known amount n_A of solvent and a known mass of solute, we can calculate the amount of solute from $n_B = n_A M_A m_B$; then the solute molar mass is the solute mass divided by n_B .

12.4.1 Freezing-point depression

As in Sec. 12.2.1, we assume the solid that forms when a dilute solution is cooled to its freezing point is pure component A.

Equation 12.3.6 on page 375 gives the general dependence of temperature on the composition of a binary liquid mixture of A and B that is in equilibrium with pure solid A. We treat the mixture as a solution. The solvent is component A, the solute is B, and the temperature is the freezing point T_f :

$$\left(\frac{\partial T_f}{\partial x_A} \right)_p = \frac{T_f^2}{\Delta_{\text{sol,A}} H} \left[\frac{\partial(\mu_A/T)}{\partial x_A} \right]_{T,p} \quad (12.4.1)$$

Consider the expression on the right side of this equation in the limit of infinite dilution. In this limit, T_f becomes T_f^* , the freezing point of the pure solvent, and $\Delta_{\text{sol,A}} H$ becomes $\Delta_{\text{fus,A}} H$, the molar enthalpy of fusion of the pure solvent.

To deal with the partial derivative on the right side of Eq. 12.4.1 in the limit of infinite dilution, we use the fact that the solvent activity coefficient γ_A approaches 1 in this limit. Then the solvent chemical potential is given by the Raoult's law relation

$$\mu_A = \mu_A^* + RT \ln x_A \quad (12.4.2)$$

(solution at infinite dilution)

where μ_A^* is the chemical potential of A in a pure-liquid reference state at the same T and p as the mixture.⁵

If the solute is an electrolyte, Eq. 12.4.2 can be derived by the same procedure as described in Sec. 9.4.6 for an ideal-dilute binary solution of a nonelectrolyte. We must calculate x_A from the amounts of all species present at infinite dilution. In the limit of infinite dilution, any electrolyte solute is completely dissociated to its constituent ions: ion pairs and weak electrolytes are completely dissociated in this limit. Thus, for a binary solution of electrolyte B with ν ions per formula unit, we should calculate x_A from

$$x_A = \frac{n_A}{n_A + \nu n_B} \quad (12.4.3)$$

where n_B is the amount of solute formula unit. (If the solute is a nonelectrolyte, we simply set ν equal to 1 in this equation.)

From Eq. 12.4.2, we can write

$$\left[\frac{\partial(\mu_A/T)}{\partial x_A} \right]_{T,p} \rightarrow R \quad \text{as } x_A \rightarrow 1 \quad (12.4.4)$$

In the limit of infinite dilution, then, Eq. 12.4.1 becomes

$$\lim_{x_A \rightarrow 1} \left(\frac{\partial T_f}{\partial x_A} \right)_p = \frac{R(T_f^*)^2}{\Delta_{\text{fus},A} H} \quad (12.4.5)$$

It is customary to relate freezing-point depression to the solute concentration c_B or molality m_B . From Eq. 12.4.3, we obtain

$$1 - x_A = \frac{\nu n_B}{n_A + \nu n_B} \quad (12.4.6)$$

In the limit of infinite dilution, when νn_B is much smaller than n_A , $1 - x_A$ approaches the value $\nu n_B/n_A$. Then, using expressions in Eq. 9.1.14 on page 227, we obtain the relations

$$\begin{aligned} dx_A &= -d(1 - x_A) = -\nu d(n_B/n_A) \\ &= -\nu V_A^* dc_B \\ &= -\nu M_A dm_B \end{aligned} \quad (12.4.7)$$

(binary solution at infinite dilution)

which transform Eq. 12.4.5 into the following:⁶

$$\begin{aligned} \lim_{c_B \rightarrow 0} \left(\frac{\partial T_f}{\partial c_B} \right)_p &= -\frac{\nu V_A^* R(T_f^*)^2}{\Delta_{\text{fus},A} H} \\ \lim_{m_B \rightarrow 0} \left(\frac{\partial T_f}{\partial m_B} \right)_p &= -\frac{\nu M_A R(T_f^*)^2}{\Delta_{\text{fus},A} H} \end{aligned} \quad (12.4.8)$$

We can apply these equations to a nonelectrolyte solute by setting ν equal to 1.

⁵At the freezing point of the mixture, the reference state is an unstable supercooled liquid. ⁶A small dependence of V_A^* on T has been ignored.

As c_B or m_B approaches zero, T_f approaches T_f^* . The freezing-point depression (a negative quantity) is $\Delta T_f = T_f - T_f^*$. In the range of molalities of a dilute solution in which $(\partial T_f / \partial m_B)_p$ is given by the expression on the right side of Eq. 12.4.8, we can write

$$\Delta T_f = -\frac{\nu M_A R (T_f^*)^2}{\Delta_{\text{fus},A} H} m_B \quad (12.4.9)$$

The **molal freezing-point depression constant** or cryoscopic constant, K_f , is defined for a binary solution by

$$K_f \stackrel{\text{def}}{=} -\lim_{m_B \rightarrow 0} \frac{\Delta T_f}{\nu m_B} \quad (12.4.10)$$

and, from Eq. 12.4.9, has a value given by

$$K_f = \frac{M_A R (T_f^*)^2}{\Delta_{\text{fus},A} H} \quad (12.4.11)$$

The value of K_f calculated from this formula depends only on the kind of solvent and the pressure. For H_2O at 1 bar, the calculated value is $K_b = 1.860 \text{ K kg mol}^{-1}$ (Prob. 12.4).

In the dilute binary solution, we have the relation

$$\Delta T_f = -\nu K_f m_B \quad (12.4.12)$$

(dilute binary solution)

This relation is useful for estimating the molality of a dilute nonelectrolyte solution ($\nu=1$) from a measurement of the freezing point. The relation is of little utility for an electrolyte solute, because at any electrolyte molality that is high enough to give a measurable depression of the freezing point, the mean ionic activity coefficient deviates greatly from unity and the relation is not accurate.

12.4.2 Boiling-point elevation

We can apply Eq. 12.3.6 to the boiling point T_b of a dilute binary solution. The pure phase of A in equilibrium with the solution is now a gas instead of a solid.⁷ Following the procedure of Sec. 12.4.1, we obtain

$$\lim_{m_B \rightarrow 0} \left(\frac{\partial T_b}{\partial m_B} \right)_p = \frac{\nu M_A R (T_b^*)^2}{\Delta_{\text{vap},A} H} \quad (12.4.13)$$

where $\Delta_{\text{vap},A} H$ is the molar enthalpy of vaporization of pure solvent at its boiling point T_b^* .

The **molal boiling-point elevation constant** or ebullioscopic constant, K_b , is defined for a binary solution by

$$K_b \stackrel{\text{def}}{=} \lim_{m_B \rightarrow 0} \frac{\Delta T_b}{\nu m_B} \quad (12.4.14)$$

where $\Delta T_b = T_b - T_b^*$ is the boiling-point elevation. Accordingly, K_b has a value given by

$$K_b = \frac{M_A R (T_b^*)^2}{\Delta_{\text{vap},A} H} \quad (12.4.15)$$

⁷We must assume the solute is nonvolatile or has negligible partial pressure in the gas phase.

BIOGRAPHICAL SKETCH

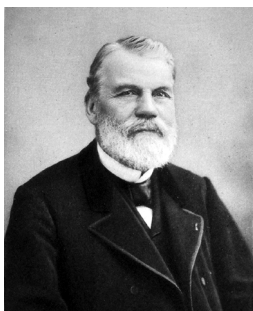
François-Marie Raoult (1830–1901)

Raoult was a French physical chemist best known for his painstaking measurements of the freezing points and vapor pressures of dilute solutions.

Raoult was born in Fournes-en-Weppes in northern France into a family of modest means—his father was an official in the local customs service. He supported himself with various teaching posts until he was able to attain his doctor's degree from the University of Paris in 1863.

Raoult began teaching at the University of Grenoble in 1867, and three years later was appointed Professor and chair of chemistry. He remained in Grenoble for the rest of his life. He was married and had three children, two of whom died before him.

His strength was in experimental measurements rather than theory. He constructed most of his own apparatus; some of it was displayed in Paris at the Centennial Museum of the Universal Exposition of 1900.^a

In all Raoult published more than 100 papers based on his measurements. The research for his doctoral thesis, and later at Grenoble, was on the thermochemistry of galvanic cells.

His first measurements of freezing-point depressions appeared in 1878. He pointed out the advantages of determining the molar mass of a substance from the freezing point of its dilute solution, and gave specific examples of this procedure. He was the first to show experimentally that the freezing-point depression of a dilute aqueous solution of an electrolyte is proportional to the number of ions per solute formula unit (Eq. 12.4.12).

Starting in 1886 Raoult began publishing his measurements of the vapor pressures of dilute solutions of nonvolatile solutes. He used two methods: (1) For a highly-volatile solvent such as diethyl ether, the solution sample was introduced above a mercury column at the upper closed end of a vertical barometer tube, and the pressure determined from the height of the column.^b (2) The solution was placed in a heated flask connected to a reflux condenser, and the pressure was reduced at the desired temperature until boiling was observed.^c

His results for diethyl ether as the solvent led him to propose the relation $\frac{f-f'}{fN} = 0.01$, where f and f' are the vapor pressures p_A^* and p_A of the pure solvent and the solution, respectively, both at the same temperature, and N is one-hundred times the solute mole fraction x_B . This relation is equivalent to the Raoult's law equation $p_A = x_A p_A^*$ (Eq. 9.4.1). He wrote:^d

With a view to ascertain whether this remarkable law is general, I dissolved in ether compounds taken from the different chemical groups, and chosen from those whose boiling points are the highest; the compounds having molecular weights which are very widely different from one another; and I measured the vapor pressures of the solutions obtained. In every case I found ... that the ratio $\frac{f-f'}{fN}$ is very nearly 0.01.

His measurements with dilute solutions of nonelectrolyte solutes in various other solvents, including benzene, ethanol, and water, gave the same results.^e He was pleased that his measurements confirmed the theory of solutions being developed by J. H. van't Hoff.

Raoult's work brought him many honors. He was most proud of being named Commander of the French Legion of Honor in 1900.

Sir William Ramsey described Raoult's personality as follows:^f

Though modest and retiring, Raoult's devotion to his work, dignity of character and sweetness of temper gained him many friends. He was not an ambitious man, but was content to work on, happy if his discoveries contributed to the advancement of science.

^aRef. [16]. ^bRef. [149]. ^cRef. [150]. ^dRef. [149]. ^eRef. [150]. ^fRef. [147].

For the boiling point of a dilute solution, the analogy of Eq. 12.4.12 is

$$\Delta T_b = \nu K_b m_B \quad (12.4.16)$$

(dilute binary solution)

Since K_f has a larger value than K_b (because $\Delta_{\text{fus,A}}H$ is smaller than $\Delta_{\text{vap,A}}H$), the measurement of freezing-point depression is more useful than that of boiling-point elevation for estimating the molality of a dilute solution.

12.4.3 Vapor-pressure lowering

In a binary two-phase system in which a solution of volatile solvent A and nonvolatile solute B is in equilibrium with gaseous A, the vapor pressure of the solution is equal to the system pressure p .

Equation 12.3.7 on page 376 gives the general dependence of p on x_A for a binary liquid mixture in equilibrium with pure gaseous A. In this equation, $\Delta_{\text{sol,A}}V$ is the molar differential volume change for the dissolution of the gas in the solution. In the limit of infinite dilution, $-\Delta_{\text{sol,A}}V$ becomes $\Delta_{\text{vap,A}}V$, the molar volume change for the vaporization of pure solvent. We also apply the limiting expressions of Eqs. 12.4.4 and 12.4.7. The result is

$$\lim_{c_B \rightarrow 0} \left(\frac{\partial p}{\partial c_B} \right)_T = -\frac{\nu V_A^* RT}{\Delta_{\text{vap,A}}V} \quad \lim_{m_B \rightarrow 0} \left(\frac{\partial p}{\partial m_B} \right)_T = -\frac{\nu M_A RT}{\Delta_{\text{vap,A}}V} \quad (12.4.17)$$

If we neglect the molar volume of the liquid solvent compared to that of the gas, and assume the gas is ideal, then we can replace $\Delta_{\text{vap,A}}V$ in the expressions above by $V_A^*(g) = RT/p_A^*$ and obtain

$$\lim_{c_B \rightarrow 0} \left(\frac{\partial p}{\partial c_B} \right)_T \approx -\nu V_A^* p_A^* \quad \lim_{m_B \rightarrow 0} \left(\frac{\partial p}{\partial m_B} \right)_T \approx -\nu M_A p_A^* \quad (12.4.18)$$

where p_A^* is the vapor pressure of the pure solvent at the temperature of the solution.

Thus, approximate expressions for vapor-pressure lowering in the limit of infinite dilution are

$$\Delta p \approx -\nu V_A^* p_A^* c_B \quad \text{and} \quad \Delta p \approx -\nu M_A p_A^* m_B \quad (12.4.19)$$

We see that the lowering in this limit depends on the kind of solvent and the solution composition, but not on the kind of solute.

12.4.4 Osmotic pressure

The osmotic pressure Π is an intensive property of a solution and was defined in Sec. 12.2.2. In a dilute solution of low Π , the approximation used to derive Eq. 12.2.11 (that the partial molar volume V_A of the solvent is constant in the pressure range from p to $p + \Pi$) becomes valid, and we can write

$$\Pi = \frac{\mu_A^* - \mu_A}{V_A} \quad (12.4.20)$$

In the limit of infinite dilution, $\mu_A^* - \mu_A$ approaches $-RT \ln x_A$ (Eq. 12.4.2) and V_A becomes the molar volume V_A^* of the pure solvent. In this limit, Eq. 12.4.20 becomes

$$\Pi = -\frac{RT \ln x_A}{V_A^*} \quad (12.4.21)$$

from which we obtain the equation

$$\lim_{x_A \rightarrow 1} \left(\frac{\partial \Pi}{\partial x_A} \right)_{T,p} = -\frac{RT}{V_A^*} \quad (12.4.22)$$

The relations in Eq. 12.4.7 transform Eq. 12.4.22 into

$$\lim_{c_B \rightarrow 0} \left(\frac{\partial \Pi}{\partial c_B} \right)_{T,p} = \nu RT \quad (12.4.23)$$

$$\lim_{m_B \rightarrow 0} \left(\frac{\partial \Pi}{\partial m_B} \right)_{T,p} = \frac{\nu RT M_A}{V_A^*} = \nu \rho_A^* RT \quad (12.4.24)$$

Equations 12.4.23 and 12.4.24 show that the osmotic pressure becomes independent of the kind of solute as the solution approaches infinite dilution. The integrated forms of these equations are

$$\Pi = \nu c_B RT \quad (12.4.25)$$

(dilute binary solution)

$$\Pi = \frac{RT M_A}{V_A^*} \nu m_B = \rho_A^* RT \nu m_B \quad (12.4.26)$$

(dilute binary solution)

Equation 12.4.25 is **van't Hoff's equation** for osmotic pressure. If there is more than one solute species, νc_B can be replaced by $\sum_{i \neq A} c_i$ and νm_B by $\sum_{i \neq A} m_i$ in these expressions.

In Sec. 9.6.3, it was stated that Π/m_B is equal to the product of ϕ_m and the limiting value of Π/m_B at infinite dilution, where $\phi_m = (\mu_A^* - \mu_A)/RT M_A \sum_{i \neq A} m_i$ is the osmotic coefficient. This relation follows directly from Eqs. 12.2.11 and 12.4.26.

12.5 Solid-Liquid Equilibria

A *freezing-point curve* (freezing point as a function of liquid composition) and a *solubility curve* (composition of a solution in equilibrium with a pure solid as a function of temperature) are different ways of describing the same physical situation. Thus, strange as it may sound, the composition x_A of an aqueous solution at the freezing point is the mole fraction solubility of ice in the solution.

12.5.1 Freezing points of ideal binary liquid mixtures

Section 12.2.1 described the use of freezing-point measurements to determine the solvent chemical potential in a solution of arbitrary composition relative to the chemical potential of the pure solvent. The way in which freezing point varies with solution composition in the limit of infinite dilution was derived in Sec. 12.4.1. Now let us consider the freezing behavior over the entire composition range of an *ideal* liquid mixture.

BIOGRAPHICAL SKETCH

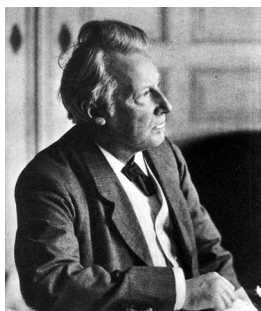
Jacobus Henricus van't Hoff (1852–1911)

van't Hoff was a Dutch chemist who gained fame from epoch-making publications in several fields of theoretical chemistry. He was an introvert who valued nature, philosophy, poetry, and the power of imagination.^a

van't Hoff was born in Rotterdam, the son of a physician, and studied at Delft, Leyden, Bonn, and Paris before obtaining his doctor's degree at Utrecht in 1874. For 18 years he was Professor of Chemistry, Mineralogy, and Geology at the University of Amsterdam. In 1896, mainly to escape burdensome lecture duties, he accepted an appointment as Professor of Physical Chemistry at the University of Berlin, where he remained for the rest of his life.

In the same year he received his doctor's degree, he published the first explanation of optical activity based on the stereoisomerism of an asymmetric carbon atom. Similar ideas were published independently two months later by the French chemist Joseph Le Bel.

In 1884 he entered the field of physical chemistry with his book *Études de Dynamique Chimique*, a systematic study of theories of reaction kinetics and chemical equilibrium. The book introduced, in the form of Eq. 12.1.12, his expression for the temperature dependence of an equilibrium constant.

van't Hoff next used thermodynamic cycles to reason that solutions of equal osmotic pressure should have the same values of freezing-point depression and of vapor-pressure lowering. Then, from Raoult's extensive measurements of these values, he found that the os-

motric pressure of a dilute solution is described by $\Pi = i c_B RT$ (Eq. 12.4.25 with ν replaced by i). The Swedish chemist Svante Arrhenius later interpreted i as the number of particles per solute formula unit, helping to validate his theory of ionic dissociation of electrolytes.

In a celebrated 1887 summary of his theory of osmotic pressure, van't Hoff wrote:^b

... the relation found permits of an important extension of the law of Avogadro, which now finds application also to all [nonelectrolyte] solutions, if only osmotic pressure is considered instead of elastic pressure. At equal osmotic pressure and equal temperature, equal volumes of the most widely different solutions contain an equal number of molecules, and, indeed, the same number which, at the same pressure and temperature, is contained in an equal volume of a gas. ... the existence of the so-called normal molecular lowering of the freezing-point and diminution of the vapor-pressure were not discovered until Raoult employed the organic compounds. These substances, almost without exception, behave normally. It may, then, have appeared daring to give Avogadro's law for solutions such a prominent place, and I should not have done so had not Arrhenius pointed out to me, by letter, the probability that salts and analogous substances, when in solution, break down into ions.

In 1901 van't Hoff was awarded the first Nobel Prize in Chemistry "in recognition of the extraordinary services he has rendered by the discovery of the laws of chemical dynamics and osmotic pressure in solutions."

van't Hoff was married with two daughters and two sons. He died of tuberculosis at age fifty-eight. In a memorial article, Frederick Donnan^c wrote:^d

The present writer is one of those whose privilege it is to have worked under van't Hoff. ... Every day endeared van't Hoff to the small band of workers in his laboratory. His joy in his work, the simple and unaffected friendliness of his nature, and the marvellous power of his mind affected us most deeply. All who worked with van't Hoff quickly learned to love and respect him, and we were no exception to the rule.

^aRef. [131]. ^bRef. [174]. ^cDonnan was an Irish physical chemist after whom the Donnan membrane equilibrium and Donnan potential (Sec. 12.7.3) are named. ^dRef. [48].

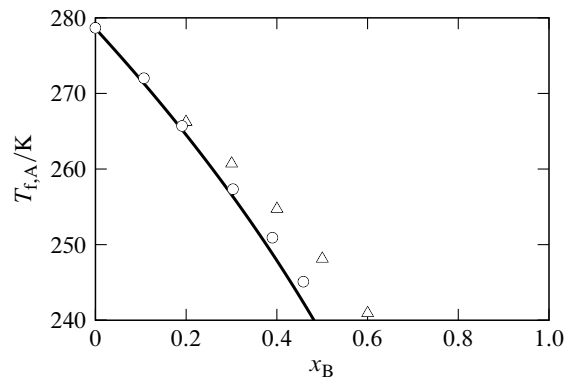

Figure 12.4 Dependence on composition of the freezing point of binary liquid mixtures with benzene as component A.^a Solid curve: calculated for an ideal liquid mixture (Eq. 12.5.2), taking the temperature variation of $\Delta_{\text{sol,A}}H$ into account. Open circles: B = toluene. Open triangles: B = cyclohexane.

^aExperimental data from Ref. [130].

The general relation between temperature and the composition of a binary liquid mixture, when the mixture is in equilibrium with pure solid A, is given by Eq. 12.3.6:

$$\left(\frac{\partial T}{\partial x_A}\right)_p = \frac{T^2}{\Delta_{\text{sol,A}}H} \left[\frac{\partial(\mu_A/T)}{\partial x_A}\right]_{T,p} \quad (12.5.1)$$

We can replace T by $T_{f,A}$ to indicate this is the temperature at which the mixture freezes to form solid A. From the expression for the chemical potential of component A in an ideal liquid mixture, $\mu_A = \mu_A^* + RT \ln x_A$, we have $[\partial(\mu_A/T)/\partial x_A]_{T,p} = R/x_A$. With these substitutions, Eq. 12.5.1 becomes

$$\left(\frac{\partial T_{f,A}}{\partial x_A}\right)_p = \frac{RT_{f,A}^2}{x_A \Delta_{\text{sol,A}}H} \quad (12.5.2)$$

(ideal liquid mixture)

Figure 12.4 compares the freezing behavior of benzene predicted by this equation with experimental freezing-point data for mixtures of benzene–toluene and benzene–cyclohexane. Any constituent that forms an ideal liquid mixture with benzene should give freezing points for the formation of solid benzene that fall on the curve in this figure. The agreement is good over a wide range of compositions for benzene–toluene mixtures (open circles), which are known to closely approximate ideal liquid mixtures. The agreement for benzene–cyclohexane mixtures (open triangles), which are not ideal liquid mixtures, is confined to the ideal-dilute region.

If we make the approximation that $\Delta_{\text{sol,A}}H$ is constant over the entire range of mixture composition, we can replace it by $\Delta_{\text{fus,A}}H$, the molar enthalpy of fusion of pure solid A at its melting point. This approximation allows us to separate the variables in Eq. 12.5.2 and integrate as follows from an arbitrary mixture composition x'_A at the freezing point $T'_{f,A}$ to pure liquid A at its freezing point $T_{f,A}^*$:

$$\int_{T'_{f,A}}^{T_{f,A}^*} \frac{dT}{T^2} = \frac{R}{\Delta_{\text{fus,A}}H} \int_{x'_A}^1 \frac{dx_A}{x_A} \quad (12.5.3)$$

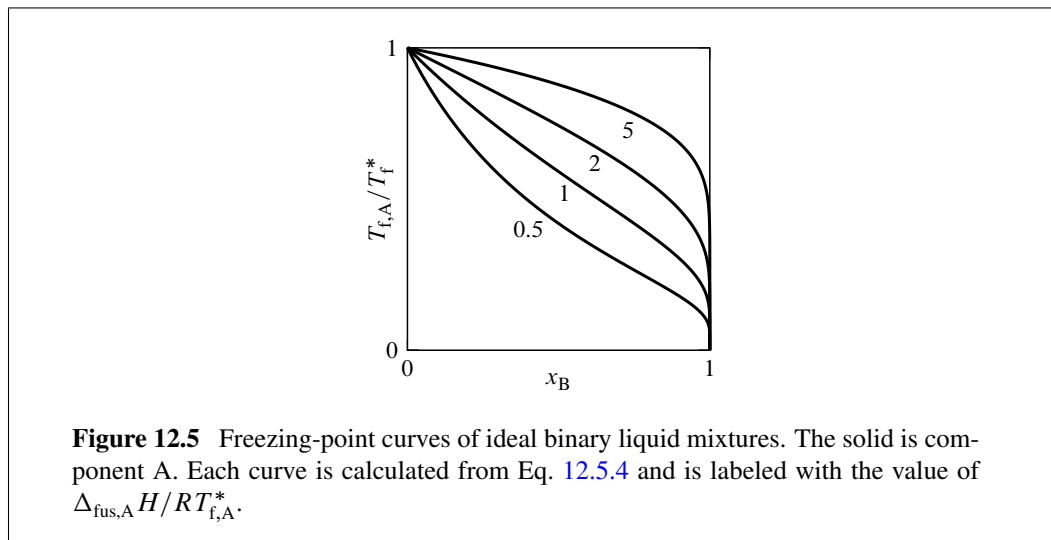

The result, after some rearrangement, is

$$\ln x_A = \frac{\Delta_{\text{fus,A}} H}{R} \left(\frac{1}{T_{\text{f,A}}^*} - \frac{1}{T_{\text{f,A}}} \right) \quad (12.5.4)$$

(ideal liquid mixture,
 $\Delta_{\text{sol,A}} H = \Delta_{\text{fus,A}} H$)

This equation was used to generate the curves shown in Fig. 12.5. Although the shape of the freezing-point curve ($T_{\text{f,A}}$ versus x_B) shown in Fig. 12.4 is concave downward, Fig. 12.5 shows this is not always the case. When $\Delta_{\text{fus,A}} H / R T_{\text{f,A}}^*$ is less than 2, the freezing-point curve at low x_B is concave *upward*.

12.5.2 Solubility of a solid nonelectrolyte

Suppose we find that a solution containing solute B at a particular combination of temperature, pressure, and composition can exist in transfer equilibrium with pure solid B at the same temperature and pressure. This solution is said to be **saturated** with respect to the solid. We can express the **solubility** of the solid in the solvent by the value of the mole fraction, concentration, or molality of B in the saturated solution. We can also define solubility as the maximum value of the solute mole fraction, concentration, or molality that can exist in the solution without the possibility of spontaneous precipitation.

This section considers the solubility of a solid nonelectrolyte. For the solution process $\text{B(s)} \rightarrow \text{B(sln)}$, the general expression for the thermodynamic equilibrium constant is $K = a_{\text{B(sln)}}/a_{\text{B(s)}}$.⁸ The activity of the pure solid is $a_{\text{B(s)}} = \Gamma_{\text{B(s)}}$. Let us use a solute standard state based on mole fraction; then the solute activity is $a_{\text{B(sln)}} = \Gamma_{x,\text{B}} \gamma_{x,\text{B}} x_{\text{B}}$. From these relations, the solubility expressed as a mole fraction is

$$x_{\text{B}} = \frac{\Gamma_{\text{B(s)}} K}{\Gamma_{x,\text{B}} \gamma_{x,\text{B}}} \quad (12.5.5)$$

⁸In this and other expressions for equilibrium constants in this chapter, activities will be assumed to be for equilibrium states, although not indicated by the “eq” subscripts used in Chap. 11.

If we measure the solubility at the standard pressure, the pressure factors $\Gamma_B(s)$ and $\Gamma_{x,B}$ are unity and the solubility is given by

$$x_B = \frac{K}{\gamma_{x,B}} \quad (12.5.6)$$

(solubility of solid B, $p=p^\circ$)

If the pressure is not exactly equal to p° , but is not very much greater, the values of the pressure factors are close to unity and Eq. 12.5.6 is a good approximation.

We can find the standard molar enthalpy of solution of B from the temperature dependence of the solubility. Combining Eqs. 12.1.12 and 12.5.6, we obtain

$$\Delta_{\text{sol},B} H^\circ = RT^2 \frac{d \ln(\gamma_{x,B} x_B)}{dT} \quad (12.5.7)$$

($p=p^\circ$)

The solubility may be small enough for us to be able to set the solute activity coefficient equal to 1, in which case Eq. 12.5.7 becomes

$$\Delta_{\text{sol},B} H^\circ = RT^2 \frac{d \ln x_B}{dT} \quad (12.5.8)$$

($p=p^\circ, \gamma_{x,B}=1$)

If the solubility x_B increases with increasing temperature, $\Delta_{\text{sol},B} H^\circ$ must be positive and the solution process is endothermic. A decrease of solubility with increasing temperature implies an exothermic solution process. These statements refer to a solid of low solubility; see page 358 for a discussion of the general relation between the temperature dependence of solubility and the sign of the molar differential enthalpy of solution at saturation.

For a solute standard state based on *molality*, we can derive equations like Eqs. 12.5.7 and 12.5.8 with $\gamma_{x,B}$ replaced by $\gamma_{m,B}$ and x_B replaced by m_B/m° . If we use a solute standard state based on *concentration*, the expressions become slightly more complicated. The solubility in this case is given by

$$c_B = \frac{\Gamma_B(s) K c^\circ}{\Gamma_{c,B} \gamma_{c,B}} \quad (12.5.9)$$

From Eq. 12.1.11, we obtain, for a nonelectrolyte solid of low solubility, the relation

$$\Delta_{\text{sol},B} H^\circ = RT^2 \left(\frac{d \ln(c_B/c^\circ)}{dT} + \alpha_A^* \right) \quad (12.5.10)$$

($p=p^\circ, \gamma_{c,B}=1$)

12.5.3 Ideal solubility of a solid

The **ideal solubility** of a solid at a given temperature and pressure is the solubility calculated on the assumptions that (1) the liquid is an ideal liquid mixture, and (2) the molar differential enthalpy of solution equals the molar enthalpy of fusion of the solid ($\Delta_{\text{sol},B} H = \Delta_{\text{fus},B} H$). These were the assumptions used to derive Eq. 12.5.4 for the freezing-point curve of an

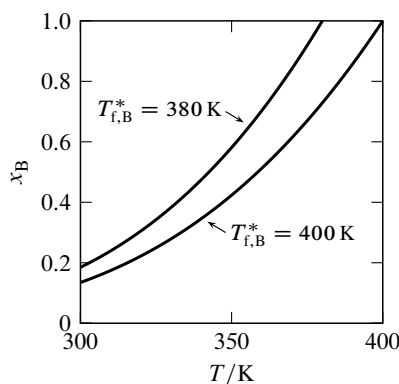

Figure 12.6 Ideal solubility of solid B as a function of T . The curves are calculated for two solids having the same molar enthalpy of fusion ($\Delta_{\text{fus},B}H = 20 \text{ kJ mol}^{-1}$) and the values of $T_{f,B}^*$ indicated.

ideal liquid mixture. In Eq. 12.5.4, we exchange the constituent labels A and B so that the solid phase is now component B:

$$\ln x_B = \frac{\Delta_{\text{fus},B}H}{R} \left(\frac{1}{T_{f,B}^*} - \frac{1}{T} \right) \quad (12.5.11)$$

(ideal solubility of solid B)

Here $T_{f,B}^*$ is the melting point of solid B.

According to Eq. 12.5.11, the ideal solubility of a solid is independent of the kind of solvent and increases with increasing temperature. For solids with similar molar enthalpies of fusion, the ideal solubility is less at a given temperature the higher is the melting point. This behavior is shown in Fig. 12.6. In order for the experimental solubility of a solid to agree even approximately with the ideal value, the solvent and solute must be chemically similar, and the temperature must be close to the melting point of the solid so that $\Delta_{\text{sol},B}H$ is close in value to $\Delta_{\text{fus},B}H$.

From the freezing behavior of benzene–toluene mixtures shown by the open circles in Fig. 12.4 on page 384, we can see that solid benzene has close to ideal solubility in liquid toluene at temperatures not lower than about 20 K below the melting point of benzene.

12.5.4 Solid compound of mixture components

Binary liquid mixtures are known in which the solid that appears when the mixture is cooled is a compound containing both components in a fixed proportion. This kind of solid is called a **solid compound**, or stoichiometric addition compound. Examples are salt hydrates (salts with fixed numbers of waters of hydration in the formula unit) and certain metal alloys.

The composition of the liquid mixture in this kind of system is variable, whereas the composition of the solid compound is fixed. Suppose the components are A and B, present in the liquid mixture at mole fractions x_A and x_B , and the solid compound has the formula A_aB_b . We assume that in the liquid phase the compound is completely dissociated with

respect to the components; that is, that no molecules of formula A_aB_b exist in the liquid. The reaction equation for the freezing process is

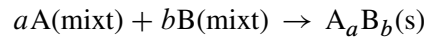

When equilibrium exists between the liquid and solid phases, the temperature is the freezing point T_f of the liquid. At equilibrium, the molar reaction Gibbs energy defined by $\Delta_r G = \sum_i \nu_i \mu_i$ is zero:

$$-a\mu_A - b\mu_B + \mu(\text{s}) = 0 \quad (12.5.12)$$

Here μ_A and μ_B refer to chemical potentials in the liquid mixture, and $\mu(\text{s})$ refers to the solid compound.

How does the freezing point of the liquid mixture vary with composition? We divide both sides of Eq. 12.5.12 by T and take differentials:

$$-a d(\mu_A/T) - b d(\mu_B/T) + d[\mu(\text{s})/T] = 0 \quad (12.5.13)$$

(phase equilibrium)

The pressure is constant. Then μ_A/T and μ_B/T are functions of T and x_A , and $\mu(\text{s})/T$ is a function only of T . We find expressions for the total differentials of these quantities at constant p with the help of Eq. 12.1.3 on page 367:

$$d(\mu_A/T) = -\frac{H_A}{T^2} dT + \frac{1}{T} \left(\frac{\partial \mu_A}{\partial x_A} \right)_{T,p} dx_A \quad (12.5.14)$$

$$d(\mu_B/T) = -\frac{H_B}{T^2} dT + \frac{1}{T} \left(\frac{\partial \mu_B}{\partial x_A} \right)_{T,p} dx_A \quad (12.5.15)$$

$$d[\mu(\text{s})/T] = -\frac{H_m(\text{s})}{T^2} dT \quad (12.5.16)$$

When we substitute these expressions in Eq. 12.5.13 and solve for dT/dx_A , setting T equal to T_f , we obtain

$$\frac{dT_f}{dx_A} = \frac{T_f}{aH_A + bH_B - H_m(\text{s})} \left[a \left(\frac{\partial \mu_A}{\partial x_A} \right)_{T,p} + b \left(\frac{\partial \mu_B}{\partial x_A} \right)_{T,p} \right] \quad (12.5.17)$$

The quantity $aH_A + bH_B - H_m(\text{s})$ in the denominator on the right side of Eq. 12.5.17 is $\Delta_{\text{sol}}H$, the molar differential enthalpy of solution of the solid compound in the liquid mixture. The two partial derivatives on the right side are related through the Gibbs–Duhem equation $x_A d\mu_A + x_B d\mu_B = 0$ (Eq. 9.2.27 on page 236), which applies to changes at constant T and p . We rearrange the Gibbs–Duhem equation to $d\mu_B = -(x_A/x_B) d\mu_A$ and divide by dx_A :

$$\left(\frac{\partial \mu_B}{\partial x_A} \right)_{T,p} = -\frac{x_A}{x_B} \left(\frac{\partial \mu_A}{\partial x_A} \right)_{T,p} \quad (12.5.18)$$

Making this substitution in Eq. 12.5.17, we obtain the equation

$$\frac{dT_f}{dx_A} = \frac{x_A T_f}{\Delta_{\text{sol}}H} \left(\frac{a}{x_A} - \frac{b}{x_B} \right) \left(\frac{\partial \mu_A}{\partial x_A} \right)_{T,p} \quad (12.5.19)$$

which can also be written in the slightly rearranged form

$$\frac{dT_f}{dx_A} = \frac{bT_f}{\Delta_{\text{sol}}H} \left(\frac{a}{b} - \frac{x_A}{1-x_A} \right) \left(\frac{\partial\mu_A}{\partial x_A} \right)_{T,p} \quad (12.5.20)$$

Suppose we heat a sample of the solid compound to its melting point to form a liquid mixture of the same composition as the solid. The molar enthalpy change of the fusion process is the molar enthalpy of fusion of the solid compound, $\Delta_{\text{fus}}H$, a *positive* quantity. When the liquid has the same composition as the solid, the dissolution and fusion processes are identical; under these conditions, $\Delta_{\text{sol}}H$ is equal to $\Delta_{\text{fus}}H$ and is positive.

Equation 12.5.20 shows that the slope of the freezing-point curve, T_f versus x_A , is zero when $x_A/(1-x_A)$ is equal to a/b , or $x_A = a/(a+b)$; that is, when the liquid and solid have the same composition. Because $(\partial\mu_A/\partial x_A)_{T,p}$ is positive, and $\Delta_{\text{sol}}H$ at this composition is also positive, we see from the equation that the slope decreases as x_A increases. Thus, the freezing-point curve has a maximum at the mixture composition that is the same as the composition of the solid compound. This conclusion applies when both components of the liquid mixture are nonelectrolytes, and also when one component is an electrolyte that dissociates into ions.

Now let us assume the liquid mixture is an ideal liquid mixture of nonelectrolytes in which μ_A obeys Raoult's law for fugacity, $\mu_A = \mu_A^* + RT \ln x_A$. The partial derivative $(\partial\mu_A/\partial x_A)_{T,p}$ then equals RT/x_A , and Eq. 12.5.19 becomes

$$\frac{dT_f}{dx_A} = \frac{RT_f^2}{\Delta_{\text{sol}}H} \left(\frac{a}{x_A} - \frac{b}{x_B} \right) \quad (12.5.21)$$

By making the approximations that $\Delta_{\text{sol}}H$ is independent of T and x_A , and is equal to $\Delta_{\text{fus}}H$, we can separate the variables and integrate as follows:

$$\int_{T_f'}^{T_f''} \frac{dT_f}{T_f^2} = \frac{R}{\Delta_{\text{fus}}H} \left(\int_{x_A'}^{x_A''} \frac{a}{x_A} dx_A + \int_{x_B'}^{x_B''} \frac{b}{x_B} dx_B \right) \quad (12.5.22)$$

(The second integral on the right side comes from changing dx_A to $-dx_B$.) The result of the integration is

$$\frac{1}{T_f'} = \frac{1}{T_f''} + \frac{R}{\Delta_{\text{fus}}H} \left(a \ln \frac{x_A''}{x_A'} + b \ln \frac{x_B''}{x_B'} \right) \quad (12.5.23)$$

(ideal liquid mixture in equilibrium with solid compound, $\Delta_{\text{sol}}H = \Delta_{\text{fus}}H$)

Let T_f' be the freezing point of a liquid mixture of composition x_A' and $x_B' = 1 - x_A'$, and let T_f'' be the melting point of the solid compound of composition $x_A'' = a/(a+b)$ and $x_B'' = b/(a+b)$. Figure 12.7 on the next page shows an example of a molten metal mixture that solidifies to an alloy of fixed composition. The freezing-point curve of this system is closely approximated by Eq. 12.5.23.

12.5.5 Solubility of a solid electrolyte

Consider an equilibrium between a crystalline salt (or other kind of ionic solid) and a solution containing the solvated ions:

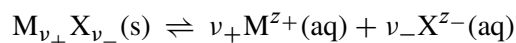

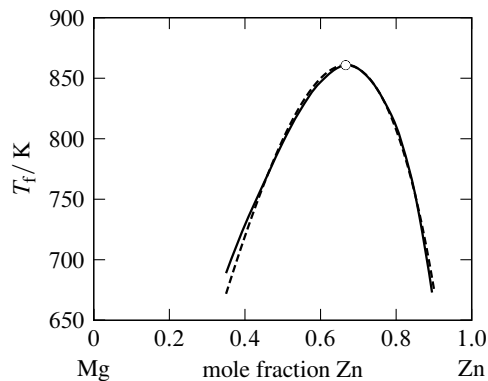

Figure 12.7 Solid curve: freezing-point curve of a liquid melt of Zn and Mg that solidifies to the solid compound Zn_2Mg .^a The curve maximum (open circle) is at the compound composition $x_{\text{Zn}}'' = 2/3$ and the solid compound melting point $T_f'' = 861$ K. Dashed curve: calculated using Eq. 12.5.23 with $\Delta_{\text{fus}}H = 15.8$ kJ mol⁻¹.

^aRef. [52], p. 603.

Here ν_+ and ν_- are the numbers of cations and anions in the formula unit of the salt, and z_+ and z_- are the charge numbers of these ions. The solution in equilibrium with the solid salt is a saturated solution. The thermodynamic equilibrium constant for this kind of equilibrium is called a **solubility product**, K_s .

We can readily derive a relation between K_s and the molalities of the ions in the saturated solution by treating the dissolved salt as a single solute substance, B. We write the equilibrium in the form $\text{B}^*(\text{s}) \rightleftharpoons \text{B}(\text{sln})$, and write the expression for the solubility product as a proper quotient of activities:

$$K_s = \frac{a_{m,\text{B}}}{a_{\text{B}}^*} \quad (12.5.24)$$

From Eq. 10.3.16 on page 295, we have $a_{m,\text{B}} = \Gamma_{m,\text{B}} \gamma_{\pm}^{\nu} (m_+/m^\circ)^{\nu_+} (m_-/m^\circ)^{\nu_-}$. This expression is valid whether or not the ions M^{z+} and X^{z-} are present in solution in the same ratio as in the solid salt. When we replace $a_{m,\text{B}}$ with this expression, and replace a_{B}^* with Γ_{B}^* (Table 9.5), we obtain

$$K_s = \left(\frac{\Gamma_{m,\text{B}}}{\Gamma_{\text{B}}^*} \right) \gamma_{\pm}^{\nu} \left(\frac{m_+}{m^\circ} \right)^{\nu_+} \left(\frac{m_-}{m^\circ} \right)^{\nu_-} \quad (12.5.25)$$

where $\nu = \nu_+ + \nu_-$ is the total number of ions per formula unit. γ_{\pm} is the mean ionic activity coefficient of the dissolved salt in the saturated solution, and the molalities m_+ and m_- refer to the ions M^{z+} and X^{z-} in this solution.

The first factor on the right side of Eq. 12.5.25, the proper quotient of pressure factors for the reaction $\text{B}^*(\text{s}) \rightarrow \text{B}(\text{sln})$, will be denoted Γ_r (the subscript “r” stands for reaction). The value of Γ_r is exactly 1 if the system is at the standard pressure, and is otherwise approximately 1 unless the pressure is very high.

If the aqueous solution is produced by allowing the salt to dissolve in pure water, or in a solution of a second solute containing no ions in common with the salt, then the ion molalities in the saturated solution are $m_+ = \nu_+ m_{\text{B}}$ and $m_- = \nu_- m_{\text{B}}$ where m_{B} is the

solubility of the salt expressed as a molality. Under these conditions, Eq. 12.5.25 becomes⁹

$$K_s = \Gamma_r \gamma_{\pm}^{\nu} \left(v_+^{\nu_+} v_-^{\nu_-} \right) \left(\frac{m_B}{m^\circ} \right)^{\nu} \quad (12.5.26)$$

(no common ion)

If the ionic strength of the saturated salt solution is sufficiently low (i.e., the solubility is sufficiently low), it may be practical to evaluate the solubility product with Eq. 12.5.26 and an estimate of γ_{\pm} from the Debye–Hückel limiting law (see Prob. 12.19). The most accurate method of measuring a solubility product, however, is through the standard cell potential of an appropriate galvanic cell (Sec. 14.3.3).

Since K_s is a thermodynamic equilibrium constant that depends only on T , and Γ_r depends only on T and p , Eq. 12.5.26 shows that any change in the solution composition at constant T and p that decreases γ_{\pm} must increase the solubility. For example, the solubility of a sparingly-soluble salt increases when a second salt, lacking a common ion, is dissolved in the solution; this is a *salting-in effect*.

Equation 12.5.25 is a general equation that applies even if the solution saturated with one salt contains a second salt with a common ion. For instance, consider the sparingly-soluble salt $M_{\nu_+} X_{\nu_-}$ in transfer equilibrium with a solution containing the more soluble salt $M_{\nu'_+} Y_{\nu'_-}$ at molality m_C . The common ion in this example is the cation M^{z+} . The expression for the solubility product is now

$$K_s = \Gamma_r \gamma_{\pm}^{\nu} (v_+ m_B + \nu'_+ m_C)^{\nu_+} (v_- m_B)^{\nu_-} / (m^\circ)^{\nu} \quad (12.5.27)$$

(common cation)

where m_B again is the solubility of the sparingly-soluble salt, and m_C is the molality of the second salt. K_s and Γ_r are constant if T and p do not change, so any increase in m_C at constant T and p must cause a decrease in the solubility m_B . This is called the *common ion effect*.

From the measured solubility of a salt in pure solvent, or in an electrolyte solution with a common cation, and a known value of K_s , we can evaluate the mean ionic activity coefficient γ_{\pm} through Eq. 12.5.26 or 12.5.27. This procedure has the disadvantage of being limited to the value of m_B existing in the saturated solution.

We find the temperature dependence of K_s by applying Eq. 12.1.12:

$$\frac{d \ln K_s}{dT} = \frac{\Delta_{\text{sol,B}} H^\circ}{RT^2} \quad (12.5.28)$$

At the standard pressure, $\Delta_{\text{sol,B}} H^\circ$ is the same as the molar enthalpy of solution at infinite dilution, $\Delta_{\text{sol,B}} H^\infty$.

12.6 Liquid–Liquid Equilibria

12.6.1 Miscibility in binary liquid systems

When two different pure liquids are unable to mix in all proportions, they are said to be *partially miscible*. When these liquids are placed in contact with one another and allowed

⁹We could also have obtained this equation by using the expression of Eq. 10.3.10 for $a_{m,B}$.

to come to thermal, mechanical, and transfer equilibrium, the result is two coexisting liquid mixtures of different compositions.

Liquids are never actually completely *immiscible*. To take an extreme case, liquid mercury, when equilibrated with water, has some H₂O dissolved in it, and some mercury dissolves in the water, although the amounts may be too small to measure.

The Gibbs phase rule for a multicomponent system to be described in Sec. 13.1 shows that a two-component, two-phase system at equilibrium has only two independent intensive variables. Thus at a given temperature and pressure, the mole fraction compositions of both phases are fixed; the compositions depend only on the identity of the substances and the temperature and pressure.

Figure 13.5 on page 431 shows a phase diagram for a typical binary liquid mixture that spontaneously separates into two phases when the temperature is lowered. The thermodynamic conditions for phase separation of this kind were discussed in Sec. 11.1.6. The phase separation is usually the result of positive deviations from Raoult's law. Typically, when phase separation occurs, one of the substances is polar and the other nonpolar.

12.6.2 Solubility of one liquid in another

Suppose substances A and B are both liquids when pure. In discussing the solubility of liquid B in liquid A, we can treat B as either a solute or as a constituent of a liquid mixture. The difference lies in the choice of the standard state or reference state of B.

We can define the solubility of B in A as the maximum amount of B that can dissolve without phase separation in a given amount of A at the given temperature and pressure. Treating B as a solute, we can express its solubility as the mole fraction of B in the phase at the point of phase separation. The addition of any more B to the system will result in two coexisting liquid phases of fixed composition, one of which will have mole fraction x_B equal to its solubility.¹⁰

Consider a system with two coexisting liquid phases α and β containing components A and B. Let α be the A-rich phase and β be the B-rich phase. For example, A could be water and B could be benzene, a hydrophobic substance. Phase α would then be an aqueous phase polluted with a low concentration of dissolved benzene, and phase β would be wet benzene. x_B^α would be the solubility of the benzene in water, expressed as a mole fraction.

Below, relations are derived for this kind of system using both choices of standard state or reference state.

Solute standard state

Assume that the two components have low mutual solubilities, so that B has a low mole fraction in phase α and a mole fraction close to 1 in phase β . It is then appropriate to treat B as a solute in phase α and as a constituent of a liquid mixture in phase β . The value of x_B^α is the solubility of liquid B in liquid A.

The equilibrium when two liquid phases are present is $B(\beta) \rightleftharpoons B(\alpha)$, and the expression for the thermodynamic equilibrium constant, with the solute standard state based on mole

¹⁰Experimentally, the solubility of B in A can be determined from the *cloud point*, the point during titration of A with B at which persistent turbidity is observed.

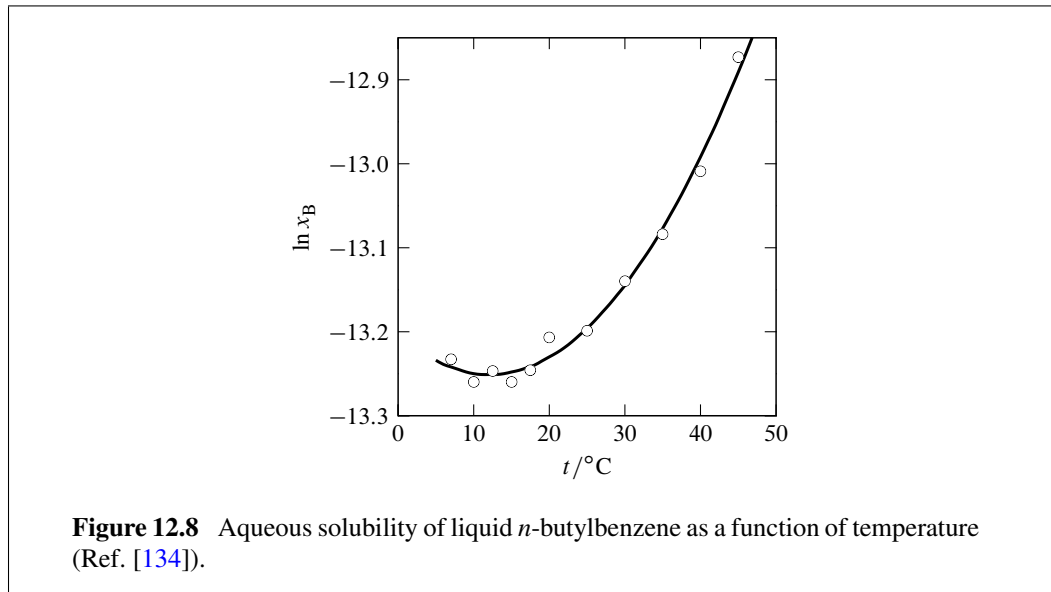

fraction, is

$$K = \frac{a_{x,B}^\alpha}{a_B^\beta} = \frac{\Gamma_{x,B}^\alpha \gamma_{x,B}^\alpha x_B^\alpha}{\Gamma_B^\beta \gamma_B^\beta x_B^\beta} \quad (12.6.1)$$

The solubility of B is then given by

$$x_B^\alpha = \frac{\Gamma_B^\beta \gamma_B^\beta x_B^\beta}{\Gamma_{x,B}^\alpha \gamma_{x,B}^\alpha} K \quad (12.6.2)$$

The values of the pressure factors and activity coefficients are all close to 1, so that the solubility of B in A is given by $x_B^\alpha \approx K$. The temperature dependence of the solubility is given by

$$\frac{d \ln x_B^\alpha}{dT} \approx \frac{d \ln K}{dT} = \frac{\Delta_{\text{sol},B} H^\circ}{RT^2} \quad (12.6.3)$$

where $\Delta_{\text{sol},B} H^\circ$ is the molar enthalpy change for the transfer at pressure p° of pure liquid solute to the solution at infinite dilution.

H_2O and *n*-butylbenzene are two liquids with very small mutual solubilities. Figure 12.8 shows that the solubility of *n*-butylbenzene in water exhibits a minimum at about 12 °C. Equation 12.6.3 allows us to deduce from this behavior that $\Delta_{\text{sol},B} H^\circ$ is negative below this temperature, and positive above.

Pure-liquid reference state

The condition for transfer equilibrium of component B is $\mu_B^\alpha = \mu_B^\beta$. If we use a pure-liquid reference state for B in both phases, this condition becomes

$$\mu_B^* + RT \ln(\gamma_B^\alpha x_B^\alpha) = \mu_B^* + RT \ln(\gamma_B^\beta x_B^\beta) \quad (12.6.4)$$

This results in the following relation between the compositions and activity coefficients:

$$\gamma_B^\alpha x_B^\alpha = \gamma_B^\beta x_B^\beta \quad (12.6.5)$$

As before, we assume the two components have low mutual solubilities, so that the B-rich phase is almost pure liquid B. Then x_B^β is only slightly less than 1, γ_B^β is close to 1, and Eq. 12.6.5 becomes $x_B^\alpha \approx 1/\gamma_B^\alpha$. Since x_B^α is much less than 1, γ_B^α must be much greater than 1.

In environmental chemistry it is common to use a pure-liquid reference state for a nonpolar liquid solute that has very low solubility in water, so that the aqueous solution is essentially at infinite dilution. Let the nonpolar solute be component B, and let the aqueous phase that is equilibrated with liquid B be phase α . The activity coefficient γ_B^α is then a *limiting activity coefficient* or *activity coefficient at infinite dilution*. As explained above, the aqueous solubility of B in this case is given by $x_B^\alpha \approx 1/\gamma_B^\alpha$, and γ_B^α is much greater than 1.

We can also relate the solubility of B to its Henry's law constant $k_{H,B}^\alpha$. Suppose the two liquid phases are equilibrated not only with one another but also with a gas phase. Since B is equilibrated between phase α and the gas, we have $\gamma_{x,B}^\alpha = f_B/k_{H,B}^\alpha x_B^\alpha$ (Table 9.4). From the equilibration of B between phase β and the gas, we also have $\gamma_B^\beta = f_B/x_B^\beta f_B^*$. By eliminating the fugacity f_B from these relations, we obtain the general relation

$$x_B^\alpha = \frac{\gamma_B^\beta x_B^\beta f_B^*}{\gamma_{x,B}^\alpha k_{H,B}^\alpha} \quad (12.6.6)$$

If we assume as before that the activity coefficients and x_B^β are close to 1, and that the gas phase behaves ideally, the solubility of B is given by $x_B^\alpha \approx p_B^*/k_{H,B}^\alpha$, where p_B^* is the vapor pressure of the pure solute.

12.6.3 Solute distribution between two partially-miscible solvents

Consider a two-component system of two equilibrated liquid phases, α and β . If we add a small quantity of a third component, C, it will distribute itself between the two phases. It is appropriate to treat C as a solute in *both* phases. The thermodynamic equilibrium constant for the equilibrium $C(\beta) \rightleftharpoons C(\alpha)$, with solute standard states based on mole fraction, is

$$K = \frac{a_{x,C}^\alpha}{a_{x,C}^\beta} = \frac{\Gamma_{x,C}^\alpha \gamma_{x,C}^\alpha x_C^\alpha}{\Gamma_{x,C}^\beta \gamma_{x,C}^\beta x_C^\beta} \quad (12.6.7)$$

We define K' as the ratio of the mole fractions of C in the two phases at equilibrium:

$$K' \stackrel{\text{def}}{=} \frac{x_C^\alpha}{x_C^\beta} = \frac{\Gamma_{x,C}^\beta \gamma_{x,C}^\beta}{\Gamma_{x,C}^\alpha \gamma_{x,C}^\alpha} K \quad (12.6.8)$$

At a fixed T and p , the pressure factors and equilibrium constant are constants. If x_C is low enough in both phases for $\gamma_{x,C}^\alpha$ and $\gamma_{x,C}^\beta$ to be close to unity, K' becomes a constant for the given T and p . The constancy of K' over a range of dilute composition is the **Nernst distribution law**.

Since solute molality and concentration are proportional to mole fraction in dilute solutions, the ratios m_C^α/m_C^β and c_C^α/c_C^β also approach constant values at a given T and p . The ratio of concentrations is called the **partition coefficient** or **distribution coefficient**.

In the limit of infinite dilution of C, the two phases have the compositions that exist when only components A and B are present. As C is added and x_C^α and x_C^β increase beyond the region of dilute solution behavior, the ratios x_B^α/x_A^α and x_B^β/x_A^β may change. Continued addition of C may increase the mutual solubilities of A and B, resulting, when enough C has been added, in a single liquid phase containing all three components. It is easier to understand this behavior with the help of a ternary phase diagram such as Fig. 13.17 on page 443.

12.7 Membrane Equilibria

A semipermeable membrane used to separate two liquid phases can, in principle, be permeable to certain species and impermeable to others. A membrane, however, may not be perfect in this respect over a long time period (see page 374). We will assume that during the period of observation, those species to which the membrane is supposed to be permeable quickly achieve transfer equilibrium, and only negligible amounts of the other species are transferred across the membrane.

Section 12.2.2 sketched a derivation of the conditions needed for equilibrium in a two-phase system in which a membrane permeable only to solvent separates a solution from pure solvent. We can generalize the results for any system with two liquid phases separated by a semipermeable membrane: in an equilibrium state, both phases must have the same temperature, and any species to which the membrane is permeable must have the same chemical potential in both phases. The two phases, however, need not and usually do not have the same pressure.

12.7.1 Osmotic membrane equilibrium

An equilibrium state in a system with two solutions of the same solvent and different solute compositions, separated by a membrane permeable only to the solvent, is called an **osmotic membrane equilibrium**. We have already seen this kind of equilibrium in an apparatus that measures osmotic pressure (Fig. 12.2 on page 373).

Consider a system with transfer equilibrium of the solvent across a membrane separating phases α and β . The phases have equal solvent chemical potentials but different pressures:

$$\mu_A^\beta(p^\beta) = \mu_A^\alpha(p^\alpha) \quad (12.7.1)$$

The dependence of μ_A on pressure in a phase of fixed temperature and composition is given by $(\partial\mu_A/\partial p)_{T,\{n_i\}} = V_A$ (from Eq. 9.2.49), where V_A is the partial molar volume of A in the phase. If we apply this relation to the solution of phase β , treat the partial molar volume V_A as independent of pressure, and integrate at constant temperature and composition from the pressure of phase α to that of phase β , we obtain

$$\mu_A^\beta(p^\beta) = \mu_A^\beta(p^\alpha) + V_A^\beta(p^\beta - p^\alpha) \quad (12.7.2)$$

By equating the two expressions for $\mu_A^\beta(p^\beta)$ and rearranging, we obtain the following expression for the pressure difference needed to achieve transfer equilibrium:

$$p^\beta - p^\alpha = \frac{\mu_A^\alpha(p^\alpha) - \mu_A^\beta(p^\alpha)}{V_A^\beta} \quad (12.7.3)$$

The pressure difference can be related to the osmotic pressures of the two phases. From Eq. 12.2.11 on page 374, the solvent chemical potential in a solution phase can be written $\mu_A(p) = \mu_A^*(p) - V_A \Pi(p)$. Using this to substitute for $\mu_A^\alpha(p^\alpha)$ and $\mu_A^\beta(p^\alpha)$ in Eq. 12.7.3, we obtain

$$p^\beta - p^\alpha = \Pi^\beta(p^\alpha) - \left(\frac{V_A^\alpha}{V_A^\beta} \right) \Pi^\alpha(p^\alpha) \quad (12.7.4)$$

12.7.2 Equilibrium dialysis

Equilibrium dialysis is a useful technique for studying the binding of a small uncharged solute species (a ligand) to a macromolecule. The macromolecule solution is placed on one side of a membrane through which it cannot pass, with a solution without the macromolecule on the other side, and the ligand is allowed to come to transfer equilibrium across the membrane. If the same solute standard state is used for the ligand in both solutions, at equilibrium the unbound ligand must have the same activity in both solutions. Measurements of the total ligand molality in the macromolecule solution and the ligand molality in the other solution, combined with estimated values of the unbound ligand activity coefficients, allow the amount of ligand bound per macromolecule to be calculated.

12.7.3 Donnan membrane equilibrium

If one of the solutions in a two-phase membrane equilibrium contains certain *charged* solute species that are unable to pass through the membrane, whereas other ions can pass through, the situation is more complicated than the osmotic membrane equilibrium described in Sec. 12.7.1. Usually if the membrane is impermeable to one kind of ion, an ion species to which it is permeable achieves transfer equilibrium across the membrane only when the phases have different pressures and different electric potentials. The equilibrium state in this case is a **Donnan membrane equilibrium**, and the resulting electric potential difference across the membrane is called the **Donnan potential**. This phenomenon is related to the membrane potentials that are important in the functioning of nerve and muscle cells (although the cells of a living organism are not, of course, in equilibrium states).

A Donnan potential can be measured electrically, with some uncertainty due to unknown liquid junction potentials, by connecting silver-silver chloride electrodes (described in Sec. 14.1) to both phases through salt bridges.

General expressions

Consider solution phases α and β separated by a semipermeable membrane. Both phases contain a dissolved salt, designated solute B, that has ν_+ cations and ν_- anions in each formula unit. The membrane is permeable to these ions. Phase β also contains a protein or other polyelectrolyte with a net positive or negative charge, together with counterions of the opposite charge that are the same species as the cation or anion of the salt. The presence of the counterions in phase β prevents the cation and anion of the salt from being present in stoichiometric amounts in this phase. The membrane is impermeable to the polyelectrolyte, perhaps because the membrane pores are too small to allow the polyelectrolyte to pass through.

The condition for transfer equilibrium of solute B is $\mu_B^\alpha = \mu_B^\beta$, or

$$(\mu_{m,B}^\circ)^\alpha + RT \ln a_{m,B}^\alpha = (\mu_{m,B}^\circ)^\beta + RT \ln a_{m,B}^\beta \quad (12.7.5)$$

Solute B has the same standard state in the two phases, so that $(\mu_{m,B}^\circ)^\alpha$ and $(\mu_{m,B}^\circ)^\beta$ are equal. The activities $a_{m,B}^\alpha$ and $a_{m,B}^\beta$ are therefore equal at equilibrium. Using the expression for solute activity from Eq. 10.3.16, which is valid for a multisolute solution, we find that at transfer equilibrium the following relation must exist between the molalities of the salt ions in the two phases:

$$\Gamma_{m,B}^\alpha (\gamma_\pm^\alpha)^{\nu} (m_+^\alpha)^{\nu_+} (m_-^\alpha)^{\nu_-} = \Gamma_{m,B}^\beta (\gamma_\pm^\beta)^{\nu} (m_+^\beta)^{\nu_+} (m_-^\beta)^{\nu_-} \quad (12.7.6)$$

To find an expression for the Donnan potential, we can equate the single-ion chemical potentials of the salt cation: $\mu_+^\alpha(\phi^\alpha) = \mu_+^\beta(\phi^\beta)$. When we use the expression of Eq. 10.1.15 for $\mu_+(\phi)$, we obtain

$$\phi^\alpha - \phi^\beta = \frac{RT}{z_+ F} \ln \frac{\Gamma_+^\beta \gamma_+^\beta m_+^\beta}{\Gamma_+^\alpha \gamma_+^\alpha m_+^\alpha} \quad (12.7.7)$$

(Donnan potential)

The condition needed for an osmotic membrane equilibrium related to the solvent can be written

$$\mu_A^\beta(p^\beta) - \mu_A^\alpha(p^\alpha) = 0 \quad (12.7.8)$$

The chemical potential of the solvent is $\mu_A = \mu_A^\circ + RT \ln a_A = \mu_A^\circ + RT \ln(\Gamma_A \gamma_A x_A)$. From Table 9.6, we have to a good approximation the expression $RT \ln \Gamma_A = V_A^*(p - p^\circ)$. With these substitutions, Eq. 12.7.8 becomes

$$RT \ln \frac{\gamma_A^\beta x_A^\beta}{\gamma_A^\alpha x_A^\alpha} + V_A^* (p^\beta - p^\alpha) = 0 \quad (12.7.9)$$

We can use this equation to estimate the pressure difference needed to maintain an equilibrium state. For dilute solutions, with γ_A^α and γ_A^β set equal to 1, the equation becomes

$$p^\beta - p^\alpha \approx \frac{RT}{V_A^*} \ln \frac{x_A^\alpha}{x_A^\beta} \quad (12.7.10)$$

In the limit of infinite dilution, $\ln x_A$ can be replaced by $-M_A \sum_{i \neq A} m_i$ (Eq. 9.6.12 on page 268), giving the relation

$$p^\beta - p^\alpha \approx \frac{M_A RT}{V_A^*} \sum_{i \neq A} (m_i^\beta - m_i^\alpha) = \rho_A^* RT \sum_{i \neq A} (m_i^\beta - m_i^\alpha) \quad (12.7.11)$$

Example

As a specific example of a Donnan membrane equilibrium, consider a system in which an aqueous solution of a polyelectrolyte with a net negative charge, together with a counterion M^+ and a salt MX of the counterion, is equilibrated with an aqueous solution of the salt across a semipermeable membrane. The membrane is permeable to the H_2O solvent and

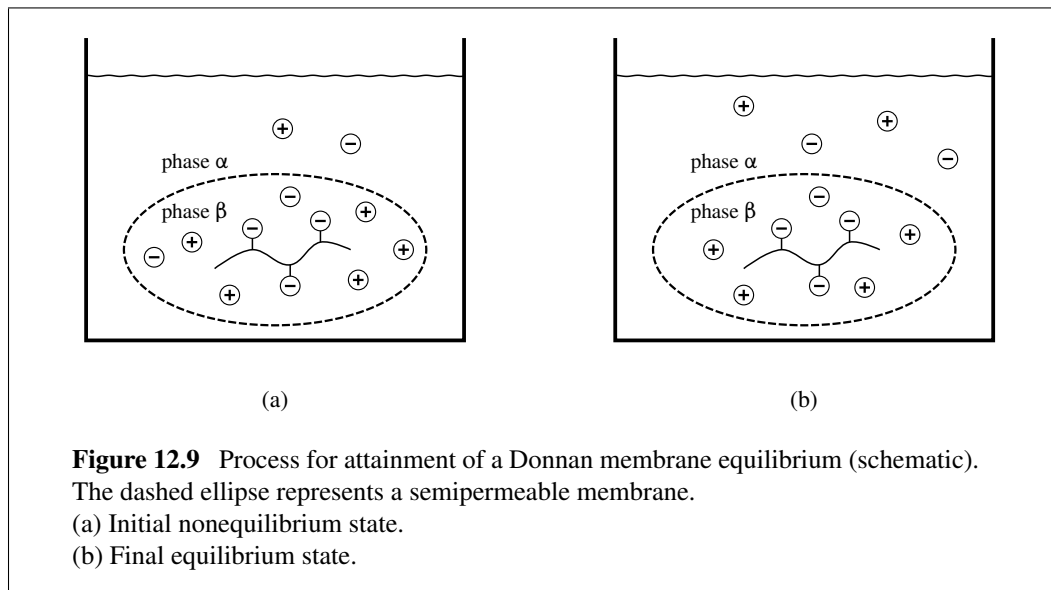

to the ions M^+ and X^- , but is impermeable to the polyelectrolyte. The species in phase α are H_2O , M^+ , and X^- ; those in phase β are H_2O , M^+ , X^- , and the polyelectrolyte. In an equilibrium state, the two phases have the same temperature but different compositions, electric potentials, and pressures.

Because the polyelectrolyte in this example has a negative charge, the system has more M^+ ions than X^- ions. Figure 12.9(a) is a schematic representation of an initial state of this kind of system. Phase β is shown as a solution confined to a closed dialysis bag immersed in phase α . The number of cations and anions shown in each phase indicate the relative amounts of these ions.

For simplicity, let us assume the two phases have equal masses of water, so that the molality of an ion is proportional to its amount by the same ratio in both phases. It is clear that in the initial state shown in the figure, the chemical potentials of both M^+ and X^- are greater in phase β (greater amounts) than in phase α , and this is a nonequilibrium state. A certain quantity of salt MX will therefore pass spontaneously through the membrane from phase β to phase α until equilibrium is attained.

The equilibrium ion molalities must agree with Eq. 12.7.6. We make the approximation that the pressure factors and mean ionic activity coefficients are unity. Then for the present example, with $\nu_+ = \nu_- = 1$, the equation becomes

$$m_+^\alpha m_-^\alpha \approx m_+^\beta m_-^\beta \quad (12.7.12)$$

There is furthermore an electroneutrality condition for each phase:

$$m_+^\alpha = m_-^\alpha \quad m_+^\beta = m_-^\beta + |z_P| m_P \quad (12.7.13)$$

Here z_P is the negative charge of the polyelectrolyte, and m_P is its molality. Substitution of these expressions into Eq. 12.7.12 gives the relation

$$(m_-^\alpha)^2 \approx (m_-^\beta + |z_P| m_P) m_-^\beta \quad (12.7.14)$$

This shows that in the equilibrium state, m_-^α is greater than m_-^β . Then Eq. 12.7.12 shows that m_+^α is less than m_+^β . These equilibrium molalities are depicted in Fig. 12.9(b).

The chemical potential of a cation, its activity, and the electric potential of the phase are related by Eq. 10.1.9 on page 289: $\mu_+ = \mu_+^\circ + RT \ln a_+ + z_+ F\phi$. In order for M^+ to have the same chemical potential in both phases, despite its lower activity in phase α , the electric potential of phase α must be greater than that of phase β . Thus the Donnan potential $\phi^\alpha - \phi^\beta$ in the present example is positive. Its value can be estimated from Eq. 12.7.7 with the values of the single-ion pressure factors and activity coefficients approximated by 1 and with z_+ for this example set equal to 1:

$$\phi^\alpha - \phi^\beta \approx \frac{RT}{F} \ln \frac{m_+^\beta}{m_+^\alpha} \quad (12.7.15)$$

The existence of a Donnan potential in the equilibrium state is the result of a very small departure of the phases on both sides of the membrane from exact electroneutrality. In the example, phase α has a minute net positive charge and phase β has a net negative charge of equal magnitude. The amount of M^+ ion transferred across the membrane to achieve equilibrium is slightly greater than the amount of X^- ion transferred; the difference between these two amounts is far too small to be measured chemically. At equilibrium, the excess charge on each side of the membrane is distributed over the boundary surface of the solution phase on that side, and is not part of the bulk phase composition.

The pressure difference $p^\beta - p^\alpha$ at equilibrium can be estimated with Eq. 12.7.11, and for the present example is found to be positive. Without this pressure difference, the solution in phase α would move spontaneously through the membrane into phase β until phase α completely disappears. With phase α open to the atmosphere, as in Fig. 12.9, the volume of phase β must be constrained in order to allow its pressure to differ from atmospheric pressure. If the volume of phase β remains practically constant, the transfer of a minute quantity of solvent across the membrane is sufficient to cause the pressure difference.

It should be clear that the existence of a Donnan membrane equilibrium introduces complications that would make it difficult to use a measured pressure difference to estimate the molar mass of the polyelectrolyte by the method of Sec. 12.4, or to study the binding of a charged ligand by equilibrium dialysis.

12.8 Liquid–Gas Equilibria

This section describes multicomponent systems in which a liquid phase is equilibrated with a gas phase.

12.8.1 Effect of liquid pressure on gas fugacity

If we vary the pressure of a liquid mixture at constant temperature and composition, there is a small effect on the fugacity of each volatile component in an equilibrated gas phase. One way to vary the pressure at essentially constant liquid composition is to change the partial pressure of a component of the gas phase that has negligible solubility in the liquid.

At transfer equilibrium, component i has the same chemical potential in both phases: $\mu_i(l) = \mu_i(g)$. Combining the relations $[\partial\mu_i(l)/\partial p]_{T,\{n_i\}} = V_i(l)$ and $\mu_i(g) = \mu_i^\circ(g) +$

$RT \ln(f_i/p^\circ)$ (Eqs. 9.2.49 and 9.3.12), we obtain

$$\frac{d \ln(f_i/p^\circ)}{dp} = \frac{V_i(l)}{RT} \quad (12.8.1)$$

(equilibrated liquid and
gas mixtures, constant T
and liquid composition)

Equation 12.8.1 shows that an increase in pressure, at constant temperature and liquid composition, causes an increase in the fugacity of each component in the gas phase.

Integration of Eq. 12.8.1 between pressures p_1 and p_2 yields

$$f_i(p_2) = f_i(p_1) \exp \left[\int_{p_1}^{p_2} \frac{V_i(l)}{RT} dp \right] \quad (12.8.2)$$

(equilibrated liquid and
gas mixtures, constant T
and liquid composition)

The exponential on the right side is called the **Poynting factor**.

The integral in the Poynting factor is simplified if we make the approximation that $V_i(l)$ is independent of pressure. Then we obtain the approximate relation

$$f_i(p_2) \approx f_i(p_1) \exp \left[\frac{V_i(l)(p_2 - p_1)}{RT} \right] \quad (12.8.3)$$

(equilibrated liquid and
gas mixtures, constant T
and liquid composition)

The effect of pressure on fugacity is usually small, and can often be neglected. For typical values of the partial molar volume $V_i(l)$, the exponential factor is close to unity unless $|p_2 - p_1|$ is very large. For instance, for $V_i(l) = 100 \text{ cm}^3 \text{ mol}^{-1}$ and $T = 300 \text{ K}$, we obtain a value for the ratio $f_i(p_2)/f_i(p_1)$ of 1.004 if $p_2 - p_1$ is 1 bar, 1.04 if $p_2 - p_1$ is 10 bar, and 1.5 if $p_2 - p_1$ is 100 bar. Thus, unless the pressure change is large, we can to a good approximation neglect the effect of total pressure on fugacity. This statement applies only to the fugacity of a substance in a gas phase that is equilibrated with a liquid phase of constant composition containing the same substance. If the liquid phase is absent, the fugacity of i in a gas phase of constant composition is of course approximately proportional to the total gas pressure.

We can apply Eqs. 12.8.2 and 12.8.3 to *pure* liquid A, in which case $V_i(l)$ is the molar volume $V_A^*(l)$. Suppose we have pure liquid A in equilibrium with pure gaseous A at a certain temperature. This is a one-component, two-phase equilibrium system with one degree of freedom (Sec. 8.1.7), so that at the given temperature the value of the pressure is fixed. This pressure is the saturation vapor pressure of pure liquid A at this temperature. We can make the pressure p greater than the saturation vapor pressure by adding a second substance to the gas phase that is essentially insoluble in the liquid, without changing the temperature or volume. The fugacity f_A is greater at this higher pressure than it was at the saturation vapor pressure. The vapor pressure p_A , which is approximately equal to f_A , has now become greater than the saturation vapor pressure. It is, however, safe to say that the difference is negligible unless the difference between p and p_A is much greater than 1 bar.

As an application of these relations, consider the effect of the size of a liquid droplet on the equilibrium vapor pressure. The calculation of Prob. 12.8(b) shows that the fugacity of

H₂O in a gas phase equilibrated with liquid water in a small droplet is slightly greater than when the liquid is in a bulk phase. The smaller the radius of the droplet, the greater is the fugacity and the vapor pressure.

12.8.2 Effect of liquid composition on gas fugacities

Consider system 1 in Fig. 9.5 on page 248. A binary liquid mixture of two volatile components, A and B, is equilibrated with a gas mixture containing A, B, and a third gaseous component C of negligible solubility used to control the total pressure. In order for A and B to be in transfer equilibrium, their chemical potentials must be the same in both phases:

$$\mu_A(l) = \mu_A^\circ(g) + RT \ln \frac{f_A}{p^\circ} \quad \mu_B(l) = \mu_B^\circ(g) + RT \ln \frac{f_B}{p^\circ} \quad (12.8.4)$$

Suppose we make an infinitesimal change in the liquid composition at constant T and p . This causes infinitesimal changes in the chemical potentials and fugacities:

$$d\mu_A(l) = RT \frac{df_A}{f_A} \quad d\mu_B(l) = RT \frac{df_B}{f_B} \quad (12.8.5)$$

By inserting these expressions in the Gibbs–Duhem equation $x_A d\mu_A = -x_B d\mu_B$ (Eq. 9.2.43), we obtain

$$\frac{x_A}{f_A} df_A = -\frac{x_B}{f_B} df_B \quad (12.8.6)$$

(binary liquid mixture equilibrated
with gas, constant T and p)

This equation is a relation between changes in gas-phase fugacities caused by a change in the liquid-phase composition. It shows that a composition change at constant T and p that increases the fugacity of A in the equilibrated gas phase must decrease the fugacity of B.

Now let us treat the liquid mixture as a binary solution with component B as the solute. In the ideal-dilute region, at constant T and p , the solute obeys Henry's law for fugacity:

$$f_B = k_{H,B} x_B \quad (12.8.7)$$

For composition changes in the ideal-dilute region, we can write

$$\frac{df_B}{dx_B} = k_{H,B} = \frac{f_B}{x_B} \quad (12.8.8)$$

With the substitution $dx_B = -dx_A$ and rearrangement, Eq. 12.8.8 becomes

$$-\frac{x_B}{f_B} df_B = dx_A \quad (12.8.9)$$

Combined with Eq. 12.8.6, this is $(x_A/f_A) df_A = dx_A$, which we can rearrange and integrate as follows within the ideal-dilute region:

$$\int_{f_A^*}^{f_A'} \frac{df_A}{f_A} = \int_1^{x_A'} \frac{dx_A}{x_A} \quad \ln \frac{f_A'}{f_A^*} = \ln x_A' \quad (12.8.10)$$

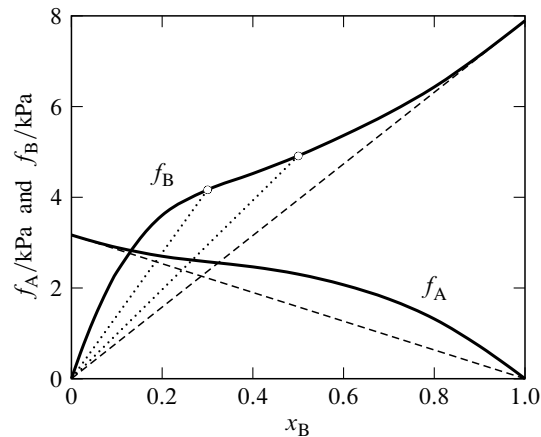

Figure 12.10 Fugacities in a gas phase equilibrated with a binary liquid mixture of H₂O (A) and ethanol (B) at 25°C and 1 bar.^a The dashed lines show Raoult's law behavior. The dotted lines illustrate the inequality $(df_B/dx_B) < (f_B/x_B)$.

^aBased on data in Ref. [47].

The result is

$$f_A = x_A f_A^* \quad (12.8.11)$$

(ideal-dilute binary solution)

Here f_A^* is the fugacity of A in a gas phase equilibrated with pure liquid A at the same T and p as the mixture. Equation 12.8.11 is Raoult's law for fugacity applied to component A.

If component B obeys Henry's law at all compositions, then the Henry's law constant $k_{H,B}$ is equal to f_B^* and B obeys Raoult's law, $f_B = x_B f_B^*$, over the entire range of x_B .

We can draw two conclusions:

1. In the ideal-dilute region of a binary solution, where the solute obeys Henry's law, the solvent must obey Raoult's law. (A similar result was derived in Sec. 9.4.6 for a solution with any number of solutes.)
2. If one component of a binary liquid mixture obeys Raoult's law at all compositions, so also must the other component. This is the definition of an ideal binary liquid mixture (Sec. 9.4.2).

Suppose we have a nonideal binary liquid mixture in which component B exhibits positive deviations from Raoult's law. An example of this behavior for the water–ethanol system is shown in Fig. 12.10. At each point on the curve of f_B versus x_B , the slope df_B/dx_B is less than the slope f_B/x_B of a line drawn from the origin to the point (as illustrated by the open circles and dotted lines in the figure), except that the two slopes become equal at $x_B=1$:

$$\frac{df_B}{dx_B} \leq \frac{f_B}{x_B} \quad (12.8.12)$$

As we can see from the figure, this relation must apply to any component whose fugacity curve exhibits a positive deviation from Raoult's law and has only one inflection point.

Algebraic operations on an inequality must be carried out with care: multiplying both sides by a quantity that can be negative may change the inequality to one with the wrong sign. In order to simplify manipulation of the inequality of Eq. 12.8.12, it helps to convert it to the following equality:¹¹

$$\frac{df_B}{dx_B} + D = \frac{f_B}{x_B} \quad (12.8.13)$$

Here D represents the difference between f_B/x_B and df_B/dx_B ; its value is a function of x_B and is, according to Eq. 12.8.12, either positive or zero. We make the substitution $dx_B = -dx_A$ and rearrange to

$$\frac{x_B df_B}{-f_B + Dx_B} = dx_A \quad (12.8.14)$$

When D is zero, this equation becomes $-x_B df_B/f_B = dx_A$. When D is positive, the left side of the equation is less than $-x_B df_B/f_B$ and is equal to dx_A , so that dx_A is less than $-x_B df_B/f_B$. Since D cannot be negative, Eq. 12.8.14 is equivalent to the following relation:

$$-\frac{x_B}{f_B} df_B \geq dx_A \quad (12.8.15)$$

A substitution from Eq. 12.8.6 gives us

$$\frac{x_A}{f_A} df_A \geq dx_A \quad \text{or} \quad \frac{df_A}{f_A} \geq \frac{dx_A}{x_A} \quad (12.8.16)$$

We can integrate both sides of the second relation as follows:¹²

$$\int_{f_A^*}^{f_A'} \frac{df_A}{f_A} \geq \int_1^{x_A'} \frac{dx_A}{x_A} \quad \ln \frac{f_A'}{f_A^*} \geq \ln x_A' \quad f_A \geq x_A f_A^* \quad (12.8.17)$$

Thus, if the curve of fugacity versus mole fraction for one component of a binary liquid mixture exhibits only positive deviations from Raoult's law, with only one inflection point, so also must the curve of the other component. In the water–ethanol system shown in Fig. 12.10, both curves have positive deviations from Raoult's law, and both have a single inflection point.

By the same method, we find that if the fugacity curve of one component has only *negative* deviations from Raoult's law with a single inflection point, the same is true of the other component.

Figure 12.11 on the next page illustrates the case of a binary mixture in which component B has only positive deviations from Raoult's law, whereas component A has both positive and negative deviations (f_A is slightly less than $x_A f_A^*$ for x_B less than 0.3). This unusual behavior is possible because both fugacity curves have two inflection points instead of the usual one. Other types of unusual nonideal behavior are possible.¹³

¹¹This procedure is similar to the rectification procedure described on page 150.

¹²The equalities are the same as Eqs. 12.8.10 and 12.8.11, with the difference that here x_A is not restricted to the ideal-dilute region.

¹³Ref. [119].

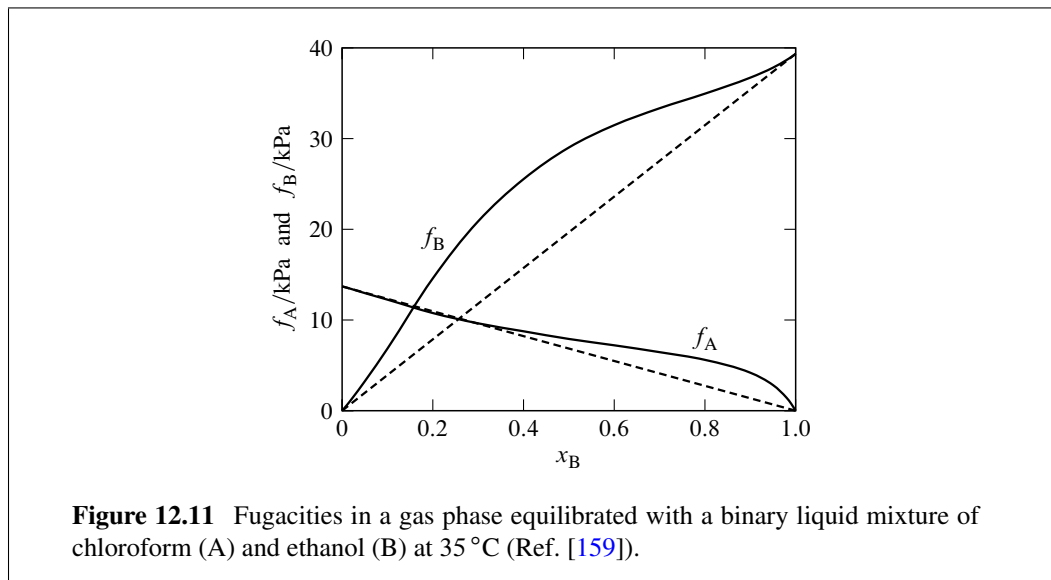

Figure 12.11 Fugacities in a gas phase equilibrated with a binary liquid mixture of chloroform (A) and ethanol (B) at 35 °C (Ref. [159]).

12.8.3 The Duhem–Margules equation

When we divide both sides of Eq. 12.8.6 by dx_A , we obtain the **Duhem–Margules equation**:

$$\frac{x_A}{f_A} \frac{df_A}{dx_A} = -\frac{x_B}{f_B} \frac{df_B}{dx_A} \quad (12.8.18)$$

(binary liquid mixture equilibrated with gas, constant T and p)

If we assume the gas mixture is ideal, the fugacities are the same as the partial pressures, and the Duhem–Margules equation then becomes

$$\frac{x_A}{p_A} \frac{dp_A}{dx_A} = -\frac{x_B}{p_B} \frac{dp_B}{dx_A} \quad (12.8.19)$$

(binary liquid mixture equilibrated with ideal gas, constant T and p)

Solving Eq. 12.8.19 for dp_B/dx_A , we obtain

$$\frac{dp_B}{dx_A} = -\frac{x_A p_B}{x_B p_A} \frac{dp_A}{dx_A} \quad (12.8.20)$$

To a good approximation, by assuming an ideal gas mixture and neglecting the effect of total pressure on fugacity, we can apply Eq. 12.8.20 to a liquid–gas system in which the total pressure is *not* constant, but instead is the sum of p_A and p_B . Under these conditions, we obtain the following expression for the rate at which the total pressure changes with the liquid composition at constant T :

$$\begin{aligned} \frac{dp}{dx_A} &= \frac{d(p_A + p_B)}{dx_A} = \frac{dp_A}{dx_A} - \frac{x_A p_B}{x_B p_A} \frac{dp_A}{dx_A} = \frac{dp_A}{dx_A} \left(1 - \frac{x_A/x_B}{p_A/p_B}\right) \\ &= \frac{dp_A}{dx_A} \left(1 - \frac{x_A/y_B}{y_A/y_B}\right) \end{aligned} \quad (12.8.21)$$

Here y_A and y_B are the mole fractions of A and B in the gas phase given by $y_A = p_A/p$ and $y_B = p_B/p$.

We can use Eq. 12.8.21 to make several predictions for a binary liquid–gas system at constant T .

- If the ratio y_A/y_B is greater than x_A/x_B (meaning that the mole fraction of A is greater in the gas than in the liquid), then $(x_A/x_B)/(y_A/y_B)$ is less than 1 and dp/dx_A must have the same sign as dp_A/dx_A , which is positive.
- Conversely, if y_A/y_B is less than x_A/x_B (i.e., the mole fraction of B is greater in the gas than in the liquid), then dp/dx_A must be negative.
- Thus *compared to the liquid, the gas phase is richer in the component whose addition to the liquid at constant temperature causes the total pressure to increase*. This statement is a version of *Konowaloff's rule*.

In some binary liquid–gas systems, the total pressure at constant temperature exhibits a maximum or minimum at a particular liquid composition. At this composition, dp/dx_A is zero but dp_A/dx_A is positive. From Eq. 12.8.21, we see that at this composition x_A/x_B must equal y_A/y_B , meaning that the liquid and gas phases have identical mole fraction compositions. The liquid with this composition is called an *azeotrope*. The behavior of systems with azeotropes will be discussed in Sec. 13.2.5.

12.8.4 Gas solubility

For the solution process $B(g) \rightarrow B(\text{sln})$, the general expression for the thermodynamic equilibrium constant is $K = a_B(\text{sln})/a_B(g)$.

The activity of B in the gas phase is given by $a_B(g) = f_B/p^\circ$. If the solute is a nonelectrolyte and we choose a standard state based on mole fraction, the activity in the solution is $a_B(\text{sln}) = \Gamma_{x,B} \gamma_{x,B} x_B$. The equilibrium constant is then given by

$$K = \frac{\Gamma_{x,B} \gamma_{x,B} x_B}{f_B/p^\circ} \quad (12.8.22)$$

and the solubility, expressed as the equilibrium mole fraction of solute in the solution, is given by

$$x_B = \frac{K f_B/p^\circ}{\Gamma_{x,B} \gamma_{x,B}} \quad (12.8.23)$$

(nonelectrolyte solute in equilibrium with gas)

At a fixed T and p , the values of K and $\Gamma_{x,B}$ are constant. Therefore any change in the solution composition that increases the value of the activity coefficient $\gamma_{x,B}$ will decrease the solubility for the same gas fugacity. This solubility decrease is often what happens when a salt is dissolved in an aqueous solution, and is known as the *salting-out effect* (Prob. 12.11).

Unless the pressure is much greater than p° , we can with negligible error set the pressure factor $\Gamma_{x,B}$ equal to 1. When the gas solubility is low and the solution contains no other solutes, the activity coefficient $\gamma_{x,B}$ is close to 1. If furthermore we assume ideal gas

behavior, then Eq. 12.8.23 becomes

$$x_B = K \frac{p_B}{p^\circ} \quad (12.8.24)$$

(nonelectrolyte solute in equilibrium
with ideal gas, $\Gamma_{x,B}=1$, $\gamma_{x,B}=1$)

The solubility is predicted to be proportional to the partial pressure. The solubility of a gas that dissociates into ions in solution has a quite different dependence on partial pressure. An example is the solubility of gaseous HCl in water to form an electrolyte solution, shown in Fig. 10.1 on page 287.

If the actual conditions are close to those assumed for Eq. 12.8.24, we can use Eq. 12.1.13 to derive an expression for the temperature dependence of the solubility for a fixed partial pressure of the gas:

$$\left(\frac{\partial \ln x_B}{\partial T} \right)_{p_B} = \frac{d \ln K}{dT} = \frac{\Delta_{\text{sol},B} H^\circ}{RT^2} \quad (12.8.25)$$

At the standard pressure, $\Delta_{\text{sol},B} H^\circ$ is the same as the molar enthalpy of solution at infinite dilution.

Since the dissolution of a gas in a liquid is invariably an exothermic process, $\Delta_{\text{sol},B} H^\circ$ is negative, and Eq. 12.8.25 predicts the solubility decreases with increasing temperature.

Note the similarity of Eq. 12.8.25 and the expressions derived previously for the temperature dependence of the solubilities of solids (Eq. 12.5.8) and liquids (Eq. 12.6.3). When we substitute the mathematical identity $dT = -T^2 d(1/T)$, Eq. 12.8.25 becomes

$$\left[\frac{\partial \ln x_B}{\partial (1/T)} \right]_{p_B} = -\frac{\Delta_{\text{sol},B} H^\circ}{R} \quad (12.8.26)$$

We can use this form to evaluate $\Delta_{\text{sol},B} H^\circ$ from a plot of $\ln x_B$ versus $1/T$.

The **ideal solubility** of a gas is the solubility calculated on the assumption that the dissolved gas obeys Raoult's law for partial pressure: $p_B = x_B p_B^*$. The ideal solubility, expressed as a mole fraction, is then given as a function of partial pressure by

$$x_B = \frac{p_B}{p_B^*} \quad (12.8.27)$$

(ideal solubility of a gas)

Here p_B^* is the vapor pressure of pure liquid solute at the same temperature and total pressure as the solution. If the pressure is too low for pure B to exist as a liquid at this temperature, we can with little error replace p_B^* with the saturation vapor pressure of liquid B at the same temperature, because the effect of total pressure on the vapor pressure of a liquid is usually negligible (Sec. 12.8.1). If the temperature is above the critical temperature of pure B, we can estimate a hypothetical vapor pressure by extrapolating the liquid–vapor coexistence curve beyond the critical point.

We can use Eq. 12.8.27 to make several predictions regarding the ideal solubility of a gas at a fixed value of p_B .

1. The ideal solubility, expressed as a mole fraction, is independent of the kind of solvent.

2. The solubility expressed as a concentration, c_B , is lower the greater is the molar volume of the solvent. This is because at constant x_B , c_B decreases as the solution volume increases.
3. The more volatile is the pure liquid solute at a particular temperature (i.e., the greater is p_B^*), the lower is the solubility.
4. The solubility decreases with increasing temperature, since p_B^* increases.

Of course, these predictions apply only to solutions that behave approximately as ideal liquid mixtures, but even for many nonideal mixtures the predictions are found to have good agreement with experiment.

As an example of the general validity of prediction 1, Hildebrand and Scott¹⁴ list the following solubilities of gaseous Cl_2 in several dissimilar solvents at 0°C and a partial pressure of 1.01 bar: $x_B = 0.270$ in heptane, $x_B = 0.288$ in SiCl_4 , and $x_B = 0.298$ in CCl_4 . These values are similar to one another and close to the ideal value $p_B/p_B^* = 0.273$.

12.8.5 Effect of temperature and pressure on Henry's law constants

Consider the solution process $\text{B}(\text{g}) \rightarrow \text{B}(\text{soln})$ for a nonelectrolyte solute B. The expression for the thermodynamic equilibrium constant, with a solute standard state based on mole fraction, is

$$K = \frac{a_{\text{B}}(\text{soln})}{a_{\text{B}}(\text{g})} = \frac{\Gamma_{x,\text{B}} \gamma_{x,\text{B}} x_{\text{B}}}{f_{\text{B}}/p^\circ} \quad (12.8.28)$$

The Henry's law constant $k_{\text{H,B}}$ is related to f_{B} and x_{B} by

$$k_{\text{H,B}} = \frac{f_{\text{B}}}{\gamma_{x,\text{B}} x_{\text{B}}} \quad (12.8.29)$$

(see Table 9.4), and is therefore related to K as follows:

$$k_{\text{H,B}} = \frac{\Gamma_{x,\text{B}} p^\circ}{K} \quad (12.8.30)$$

(nonelectrolyte solute)

The pressure factor $\Gamma_{x,\text{B}}$ is a function of T and p , and K is a function only of T . The value of $k_{\text{H,B}}$ therefore depends on both T and p .

At the standard pressure $p^\circ = 1$ bar, the value of $\Gamma_{x,\text{B}}$ is unity, and Eqs. 12.1.13 and 12.1.14 then give the following expressions for the dependence of the dimensionless quantity $k_{\text{H,B}}/p^\circ$ on temperature:

$$\frac{d \ln(k_{\text{H,B}}/p^\circ)}{dT} = -\frac{d \ln K}{dT} = -\frac{\Delta_{\text{sol,B}} H^\circ}{RT^2} \quad (12.8.31)$$

($p=p^\circ$)

$$\frac{d \ln(k_{\text{H,B}}/p^\circ)}{d(1/T)} = -\frac{d \ln K}{d(1/T)} = \frac{\Delta_{\text{sol,B}} H^\circ}{R} \quad (12.8.32)$$

($p=p^\circ$)

¹⁴Ref. [85], Chap. XV.

These expressions can be used with little error at any pressure that is not much greater than p° , say up to at least 2 bar, because under these conditions $\Gamma_{x,B}$ does not differ appreciably from unity (page 275).

To find the dependence of $k_{H,B}$ on pressure, we substitute $\Gamma_{x,B}$ in Eq. 12.8.30 with the expression for $\Gamma_{x,B}$ at pressure p' found in Table 9.6:

$$k_{H,B}(p') = \frac{\Gamma_{x,B}(p') p^\circ}{K} = \frac{p^\circ}{K} \exp\left(\int_{p^\circ}^{p'} \frac{V_B^\infty}{RT} dp\right) \quad (12.8.33)$$

We can use Eq. 12.8.33 to compare the values of $k_{H,B}$ at the same temperature and two different pressures, p_1 and p_2 :

$$k_{H,B}(p_2) = k_{H,B}(p_1) \exp\left(\int_{p_1}^{p_2} \frac{V_B^\infty}{RT} dp\right) \quad (12.8.34)$$

An approximate version of this relation, found by treating V_B^∞ as independent of pressure, is

$$k_{H,B}(p_2) \approx k_{H,B}(p_1) \exp\left[\frac{V_B^\infty(p_2 - p_1)}{RT}\right] \quad (12.8.35)$$

Unless $|p_2 - p_1|$ is much greater than 1 bar, the effect of pressure on $k_{H,B}$ is small; see Prob. 12.12 for an example.

12.9 Reaction Equilibria

The definition of the thermodynamic equilibrium constant of a reaction or other chemical process is given by Eq. 11.8.9:

$$K = \prod_i (a_i)_{\text{eq}}^{v_i} \quad (12.9.1)$$

The activity a_i of each reactant or product species is based on an appropriate standard state. We can replace each activity on the right side of Eq. 12.9.1 by an expression in Table 12.2 on the next page.

For example, consider the following heterogeneous equilibrium that is important in the formation of limestone caverns:

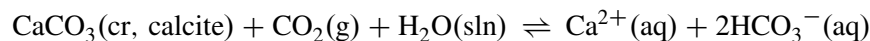

If we treat H_2O as a solvent and Ca^{2+} and HCO_3^- as the solute species, then we write the thermodynamic equilibrium constant as follows:

$$K = \frac{a_+ a_-^2}{a_{\text{CaCO}_3} a_{\text{CO}_2} a_{\text{H}_2\text{O}}} = \Gamma_r \frac{\gamma_+ \gamma_-^2 m_+ m_-^2 / (m^\circ)^3}{(f_{\text{CO}_2}/p^\circ) \gamma_{\text{H}_2\text{O}} x_{\text{H}_2\text{O}}} \quad (12.9.2)$$

The subscripts $+$ and $-$ refer to the Ca^{2+} and HCO_3^- ions, and all quantities are for the system at reaction equilibrium. Γ_r is the proper quotient of pressure factors, given for this reaction by¹⁵

$$\Gamma_r = \frac{\Gamma_+ \Gamma_-^2}{\Gamma_{\text{CaCO}_3} \Gamma_{\text{H}_2\text{O}}} \quad (12.9.3)$$

¹⁵The product $\Gamma_+ \Gamma_-^2$ in the numerator of Eq. 12.9.3 is the pressure factor $\Gamma_{m,B}$ for the solute $\text{Ca}(\text{HCO}_3)_2$ (see Eq. 10.3.11 on page 294).

Table 12.2 Expressions for activities (from Table 9.5 and Eqs. 10.1.14 and 10.3.16)

Species	Activity
Pure gas	$a(\text{g}) = \frac{f}{p^\circ}$
Pure liquid or solid	$a = \Gamma$
Substance i in a gas mixture	$a_i(\text{g}) = \frac{f_i}{p^\circ}$
Substance i in a liquid or solid mixture	$a_i = \Gamma_i \gamma_i x_i$
Solvent A of a solution	$a_A = \Gamma_A \gamma_A x_A$
Nonelectrolyte solute B, mole fraction basis	$a_{x,B} = \Gamma_{x,B} \gamma_{x,B} x_B$
Nonelectrolyte solute B, concentration basis	$a_{c,B} = \Gamma_{c,B} \gamma_{c,B} \frac{c_B}{c^\circ}$
Nonelectrolyte solute B, molality basis	$a_{m,B} = \Gamma_{m,B} \gamma_{m,B} \frac{m_B}{m^\circ}$
Electrolyte solute B	$a_{m,B} = \Gamma_{m,B} \gamma_{\pm}^{\nu} \left(\frac{m_+}{m^\circ}\right)^{\nu_+} \left(\frac{m_-}{m^\circ}\right)^{\nu_-}$
Ion in solution	$a_+ = \Gamma_+ \gamma_+ \frac{m_+}{m^\circ} \quad a_- = \Gamma_- \gamma_- \frac{m_-}{m^\circ}$

Unless the pressure is very high, we can with little error set the value of Γ_r equal to unity.

Equation 12.9.2 is an example of a “mixed” equilibrium constant—one using more than one kind of standard state. From the definition of the mean ionic activity coefficient (Eq. 10.3.7), we can replace the product $\gamma_+ \gamma_-^2$ by γ_{\pm}^3 , where γ_{\pm} is the mean ionic activity coefficient of aqueous $\text{Ca}(\text{HCO}_3)_2$:

$$K = \Gamma_r \frac{\gamma_{\pm}^3 m_+ m_-^2 / (m^\circ)^3}{(f_{\text{CO}_2} / p^\circ) \gamma_{\text{H}_2\text{O}} x_{\text{H}_2\text{O}}} \quad (12.9.4)$$

Instead of treating the aqueous Ca^{2+} and HCO_3^- ions as solute species, we can regard the dissolved $\text{Ca}(\text{HCO}_3)_2$ electrolyte as the solute and write

$$K = \frac{a_{m,B}}{a_{\text{CaCO}_3} a_{\text{CO}_2} a_{\text{H}_2\text{O}}} \quad (12.9.5)$$

We then obtain Eq. 12.9.4 by replacing $a_{m,B}$ with the expression in Table 12.2 for an electrolyte solute.

The value of K depends only on T , and the value of Γ_r depends only on T and p . Suppose we dissolve some NaCl in the aqueous phase while maintaining the system at constant T and p . The increase in the ionic strength will alter γ_{\pm} and necessarily cause a compensating change in the solute molarity in order for the system to remain in reaction equilibrium.

An example of a different kind of reaction equilibrium is the dissociation (ionization) of a weak monoprotic acid such as acetic acid

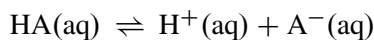

for which the thermodynamic equilibrium constant (the *acid dissociation constant*) is

$$K_a = \Gamma_r \frac{\gamma_+ \gamma_- m_+ m_-}{\gamma_{m,\text{HA}} m_{\text{HA}} m^\circ} = \Gamma_r \frac{\gamma_{\pm}^2 m_+ m_-}{\gamma_{m,\text{HA}} m_{\text{HA}} m^\circ} \quad (12.9.6)$$

Suppose the solution is prepared from water and the acid, and H^+ from the dissociation of H_2O is negligible compared to H^+ from the acid dissociation. We may then write $m_+ = m_- = \alpha m_{\text{B}}$, where α is the degree of dissociation and m_{B} is the overall molality of the acid. The molality of the undissociated acid is $m_{\text{HA}} = (1 - \alpha)m_{\text{B}}$, and the dissociation constant can be written

$$K_a = \Gamma_r \frac{\gamma_{\pm}^2 \alpha^2 m_{\text{B}} / m^\circ}{\gamma_{m,\text{HA}} (1 - \alpha)} \quad (12.9.7)$$

From this equation, we see that a change in the ionic strength that decreases γ_{\pm} when T , p , and m_{B} are held constant must increase the degree of dissociation (Prob. 12.17).

12.10 Evaluation of Standard Molar Quantities

Some of the most useful experimentally-derived data for thermodynamic calculations are values of standard molar reaction enthalpies, standard molar reaction Gibbs energies, and standard molar reaction entropies. The values of these quantities for a given reaction are related, as we know (Eq. 11.8.21), by

$$\Delta_r G^\circ = \Delta_r H^\circ - T \Delta_r S^\circ \quad (12.10.1)$$

and $\Delta_r S^\circ$ can be calculated from the standard molar entropies of the reactants and products using Eq. 11.8.22:

$$\Delta_r S^\circ = \sum_i \nu_i S_i^\circ \quad (12.10.2)$$

The standard molar quantities appearing in Eqs. 12.10.1 and 12.10.2 can be evaluated through a variety of experimental techniques. Reaction calorimetry can be used to evaluate $\Delta_r H^\circ$ for a reaction (Sec. 11.5). Calorimetric measurements of heat capacity and phase-transition enthalpies can be used to obtain the value of S_i° for a solid or liquid (Sec. 6.2.1). For a gas, spectroscopic measurements can be used to evaluate S_i° (Sec. 6.2.2). Evaluation of a thermodynamic equilibrium constant and its temperature derivative, for any of the kinds of equilibria discussed in this chapter (vapor pressure, solubility, chemical reaction, etc.), can provide values of $\Delta_r G^\circ$ and $\Delta_r H^\circ$ through the relations $\Delta_r G^\circ = -RT \ln K$ and $\Delta_r H^\circ = -R d \ln K / d(1/T)$.

In addition to these methods, measurements of cell potentials are useful for a reaction that can be carried out reversibly in a galvanic cell. Section 14.3.3 will describe how the standard cell potential and its temperature derivative allow $\Delta_r H^\circ$, $\Delta_r G^\circ$, and $\Delta_r S^\circ$ to be evaluated for such a reaction.

An efficient way of tabulating the results of experimental measurements is in the form of standard molar enthalpies and Gibbs energies of *formation*. These values can be used to

generate the values of standard molar reaction quantities for reactions not investigated directly. The relations between standard molar reaction and formation quantities (Sec. 11.3.2) are

$$\Delta_r H^\circ = \sum_i \nu_i \Delta_f H^\circ(i) \quad \Delta_r G^\circ = \sum_i \nu_i \Delta_f G^\circ(i) \quad (12.10.3)$$

and for ions the conventions used are

$$\Delta_f H^\circ(\text{H}^+, \text{aq}) = 0 \quad \Delta_f G^\circ(\text{H}^+, \text{aq}) = 0 \quad S_m^\circ(\text{H}^+, \text{aq}) = 0 \quad (12.10.4)$$

Appendix H gives an abbreviated set of values of $\Delta_f H^\circ$, S_m° , and $\Delta_f G^\circ$ at 298.15 K.

For examples of the evaluation of standard molar reaction quantities and standard molar formation quantities from measurements made by various experimental techniques, see Probs. 12.18–12.20, 14.3, and 14.4.

PROBLEMS

An underlined problem number or problem-part letter indicates that the numerical answer appears in Appendix I.

12.1 Consider the heterogeneous equilibrium $\text{CaCO}_3(\text{s}) \rightleftharpoons \text{CaO}(\text{s}) + \text{CO}_2(\text{g})$. Table 12.3 lists pressures measured over a range of temperatures for this system.

Table 12.3 Pressure of an equilibrium system containing $\text{CaCO}_3(\text{s})$, $\text{CaO}(\text{s})$, and $\text{CO}_2(\text{g})$ ^a

$t/^\circ\text{C}$	p/Torr	$t/^\circ\text{C}$	p/Torr
842.3	343.0	904.3	879.0
852.9	398.6	906.5	875.0
854.5	404.1	937.0	1350
868.9	510.9	937.0	1340

^aRef. [163].

- (a) What is the approximate relation between p and K ?
- (b) Plot these data in the form $\ln K$ versus $1/T$, or fit $\ln K$ to a linear function of $1/T$. Then, evaluate the temperature at which the partial pressure of the CO_2 is 1 bar, and the standard molar reaction enthalpy at this temperature.
- 12.2** For a homogeneous reaction in which the reactants and products are solutes in a solution, write a rigorous relation between the standard molar reaction enthalpy and the temperature dependence of the thermodynamic equilibrium constant, with solute standard states based on concentration.
- 12.3** Derive an expression for the standard molar reaction entropy of a reaction that can be used to calculate its value from the thermodynamic equilibrium constant and its temperature derivative. Assume that no solute standard states are based on concentration.

Table 12.4 Properties of H_2O at 1 bar

M	t_f	t_b	$\Delta_{\text{fus}}H$	$\Delta_{\text{vap}}H$
$18.0153 \text{ g mol}^{-1}$	$0.00 \text{ }^\circ\text{C}$	$99.61 \text{ }^\circ\text{C}$	$6.010 \text{ kJ mol}^{-1}$	$40.668 \text{ kJ mol}^{-1}$

- 12.4** Use the data in Table 12.4 to evaluate the molal freezing-point depression constant and the molal boiling-point elevation constant for H_2O at a pressure of 1 bar.
- 12.5** An aqueous solution of the protein bovine serum albumin, containing $2.00 \times 10^{-2} \text{ g}$ of protein per cubic centimeter, has an osmotic pressure of $8.1 \times 10^{-3} \text{ bar}$ at $0 \text{ }^\circ\text{C}$. Estimate the molar mass of this protein.
- 12.6** Figure 12.8 on page 393 shows a curve fitted to experimental points for the aqueous solubility of n -butylbenzene. The curve has the equation $\ln x_B = a(t/^\circ\text{C} - b)^2 + c$, where the constants have the values $a = 3.34 \times 10^{-4}$, $b = 12.13$, and $c = -13.25$. Assume that the saturated solution behaves as an ideal-dilute solution, use a solute standard state based on mole fraction, and calculate $\Delta_{\text{sol,B}}H^\circ$ and $\Delta_{\text{sol,B}}S^\circ$ at $5.00 \text{ }^\circ\text{C}$, $12.13 \text{ }^\circ\text{C}$ (the temperature of minimum solubility), and $25.00 \text{ }^\circ\text{C}$.

12.7 Consider a hypothetical system in which two aqueous solutions are separated by a semipermeable membrane. Solution α is prepared by dissolving 1.00×10^{-5} mol KCl in 10.0 g water. Solution β is prepared from 1.00×10^{-5} mol KCl and 1.00×10^{-6} mol of the potassium salt of a polyelectrolyte dissolved in 10.0 g water. All of solution β is used to fill a dialysis bag, which is then sealed and placed in solution α .

Each polyelectrolyte ion has a charge of -10 . The membrane of the dialysis bag is permeable to the water molecules and to the K^+ and Cl^- ions, but not to the polyelectrolyte. The system comes to equilibrium at 25.00°C . Assume that the volume of the dialysis bag remains constant. Also make the drastic approximation that both solutions behave as ideal-dilute solutions.

- Find the equilibrium molality of each solute species in the two solution phases.
- Describe the amounts and directions of any macroscopic transfers of ions across the membrane that are required to establish the equilibrium state.
- Estimate the Donnan potential, $\phi^\alpha - \phi^\beta$.
- Estimate the pressure difference across the membrane at equilibrium. (The density of liquid H_2O at 25.00°C is 0.997 g cm^{-3} .)

12.8 The derivation of Prob. 9.3 on page 282 shows that the pressure in a liquid droplet of radius r is greater than the pressure of the surrounding equilibrated gas phase by a quantity $2\gamma/r$, where γ is the surface tension.

- Consider a droplet of water of radius 1.00×10^{-6} m at 25°C suspended in air of the same temperature. The surface tension of water at this temperature is 0.07199 J m^{-2} . Find the pressure in the droplet if the pressure of the surrounding air is 1.00 bar.
- Calculate the difference between the fugacity of H_2O in the air of pressure 1.00 bar equilibrated with this water droplet, and the fugacity in air equilibrated at the same temperature and pressure with a pool of liquid water having a flat surface. Liquid water at 25°C and 1 bar has a vapor pressure of 0.032 bar and a molar volume of $1.807 \times 10^{-5} \text{ m}^3 \text{ mol}^{-1}$.

12.9 For a solution process in which species B is transferred from a gas phase to a liquid solution, find the relation between $\Delta_{\text{sol}}G^\circ$ (solute standard state based on mole fraction) and the Henry's law constant $k_{\text{H,B}}$.

12.10 Crovetto¹⁶ reviewed the published data for the solubility of gaseous CO_2 in water, and fitted the Henry's law constant $k_{\text{H,B}}$ to a function of temperature. Her recommended values of $k_{\text{H,B}}$ at five temperatures are 1233 bar at 15.00°C , 1433 bar at 20.00°C , 1648 bar at 25.00°C , 1874 bar at 30.00°C , and 2111 bar at 35°C .

- The partial pressure of CO_2 in the atmosphere is typically about 3×10^{-4} bar. Assume a fugacity of 3.0×10^{-4} bar, and calculate the aqueous solubility at 25.00°C expressed both as a mole fraction and as a molality.
- Find the standard molar enthalpy of solution at 25.00°C .
- Dissolved carbon dioxide exists mostly in the form of CO_2 molecules, but a small fraction exists as H_2CO_3 molecules, and there is also some ionization:

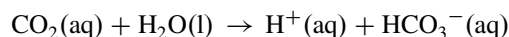

(The equilibrium constant of this reaction is often called the first ionization constant of carbonic acid.) Combine the $k_{\text{H,B}}$ data with data in Appendix H to evaluate K and $\Delta_r H^\circ$ for the ionization reaction at 25.00°C . Use solute standard states based on molality, which are also the solute standard states used for the values in Appendix H.

¹⁶Ref. [40].

- 12.11** The solubility of gaseous O_2 at a partial pressure of 1.01 bar and a temperature of 310.2 K, expressed as a concentration, is $1.07 \times 10^{-3} \text{ mol dm}^{-3}$ in pure water and $4.68 \times 10^{-4} \text{ mol dm}^{-3}$ in a 3.0 M aqueous solution of KCl.¹⁷ This solubility decrease is the *salting-out effect*. Calculate the activity coefficient $\gamma_{c,B}$ of O_2 in the KCl solution.
- 12.12** At 298.15 K, the partial molar volume of $CO_2(\text{aq})$ is $33 \text{ cm}^3 \text{ mol}^{-1}$. Use Eq. 12.8.35 to estimate the percent change in the value of the Henry's law constant $k_{H,B}$ for aqueous CO_2 at 298.15 K when the total pressure is changed from 1.00 bar to 10.00 bar.
- 12.13** Rettich et al.¹⁸ made high-precision measurements of the solubility of gaseous oxygen (O_2) in water. Each measurement was made by equilibrating water and oxygen in a closed vessel for a period of up to two days, at a temperature controlled within $\pm 0.003 \text{ K}$. The oxygen was extracted from samples of known volume of the equilibrated liquid and gas phases, and the amount of O_2 in each sample was determined from p - V - T measurements taking gas nonideality into account. It was then possible to evaluate the mole fraction x_B of O_2 in the liquid phase and the ratio (n_B^g/V^g) for the O_2 in the gas phase.

Table 12.5 Data for Problem 12.13 (A = H_2O , B = O_2)

$T = 298.152 \text{ K}$	Second virial coefficients:
$x_B = 2.02142 \times 10^{-5}$	$B_{AA} = -1152 \times 10^{-6} \text{ m}^3 \text{ mol}^{-1}$
$(n_B^g/V^g) = 35.9957 \text{ mol m}^{-3}$	$B_{BB} = -16.2 \times 10^{-6} \text{ m}^3 \text{ mol}^{-1}$
$p_A^* = 3167.13 \text{ Pa}$	$B_{AB} = -27.0 \times 10^{-6} \text{ m}^3 \text{ mol}^{-1}$
$V_A^* = 18.069 \times 10^{-6} \text{ m}^3 \text{ mol}^{-1}$	
$V_B^\infty = 31.10 \times 10^{-6} \text{ m}^3 \text{ mol}^{-1}$	

Table 12.5 gives values of physical quantities at $T = 298.152 \text{ K}$ needed for this problem. The values of x_B and (n_B^g/V^g) were obtained by Rettich et al from samples of liquid and gas phases equilibrated at temperature T , as explained above. p_A^* is the saturation vapor pressure of pure liquid water at this temperature.

Your calculations will be similar to those used by Rettich et al to obtain values of the Henry's law constant of oxygen to six significant figures. Your own calculations should also be carried out to six significant figures. For the gas constant, use the value $R = 8.31447 \text{ J K}^{-1} \text{ mol}^{-1}$.

The method you will use to evaluate the Henry's law constant $k_{H,B} = f_B/x_B$ at the experimental temperature and pressure is as follows. The value of x_B is known, and you need to find the fugacity f_B of the O_2 in the gas phase. f_B can be calculated from ϕ_B and p_B . These in turn can be calculated from the pressure p , the mole fraction y_B of O_2 in the gas phase, and known values of second virial coefficients. You will calculate p and y_B by an iterative procedure. Assume the gas has the virial equation of state $(V^g/n^g) = (RT/p) + B$ (Eq. 9.3.21) and use relevant relations in Sec. 9.3.4.

- For the equilibrated liquid-gas system, calculate initial approximate values of p and y_B by assuming that p_A is equal to p_A^* and p_B is equal to $(n_B^g/V^g)RT$.
- Use your approximate values of p and y_B from part (a) to calculate ϕ_A , the fugacity coefficient of A in the gas mixture.
- Evaluate the fugacity f_A of the H_2O in the gas phase. Assume p , y_B , and ϕ_A have the values you calculated in parts (a) and (b). Hint: start with the value of the saturation vapor pressure of pure water.

¹⁷Ref. [112]. ¹⁸Ref. [152].

- (d) Use your most recently calculated values of p , ϕ_A , and f_A to calculate an improved value of y_B .
- (e) Use your current values of p and y_B to evaluate the compression factor Z of the gas mixture, taking nonideality into account.
- (f) Derive a general expression for p as a function of (n_B^g/V^g) , T , y_B , and Z . Use this expression to calculate an improved value of p .
- (g) Finally, use the improved values of p and y_B to evaluate the Henry's law constant $k_{H,B}$ at the experimental T and p .
- 12.14** The method described in Prob. 12.13 has been used to obtain high-precision values of the Henry's law constant, $k_{H,B}$, for gaseous methane dissolved in water.¹⁹ Table 12.6 lists values

Table 12.6 Data for Prob. 12.14

$1/(T/K)$	$\ln(k_{H,B}/p^\circ)$	$1/(T/K)$	$\ln(k_{H,B}/p^\circ)$
0.00363029	10.0569	0.00329870	10.6738
0.00359531	10.1361	0.00319326	10.8141
0.00352175	10.2895	0.00314307	10.8673
0.00347041	10.3883	0.00309444	10.9142
0.00341111	10.4951	0.00304739	10.9564
0.00335390	10.5906		

of $\ln(k_{H,B}/p^\circ)$ at eleven temperatures in the range 275 K–328 K and at pressures close to 1 bar. Use these data to evaluate $\Delta_{\text{sol,B}}H^\circ$ and $\Delta_{\text{sol,B}}C_p^\circ$ at $T = 298.15$ K. This can be done by a graphical method. Better precision will be obtained by making a least-squares fit of the data to the three-term polynomial

$$\ln(k_{H,B}/p^\circ) = a + b(1/T) + c(1/T)^2$$

and using the values of the coefficients a , b , and c for the evaluations.

- 12.15** Liquid water and liquid benzene have very small mutual solubilities. Equilibria in the binary water–benzene system were investigated by Tucker, Lane, and Christian²⁰ as follows. A known amount of distilled water was admitted to an evacuated, thermostatted vessel. Part of the water vaporized to form a vapor phase. Small, precisely measured volumes of liquid benzene were then added incrementally from the sample loop of a liquid-chromatography valve. The benzene distributed itself between the liquid and gaseous phases in the vessel. After each addition, the pressure was read with a precision pressure gauge. From the known amounts of water and benzene and the total pressure, the liquid composition and the partial pressure of the benzene were calculated. The fugacity of the benzene in the vapor phase was calculated from its partial pressure and the second virial coefficient.

At a fixed temperature, for mole fractions x_B of benzene in the liquid phase up to about 3×10^{-4} (less than the solubility of benzene in water), the fugacity of the benzene in the equilibrated gas phase was found to have the following dependence on x_B :

$$\frac{f_B}{x_B} = k_{H,B} - Ax_B$$

Here $k_{H,B}$ is the Henry's law constant and A is a constant related to deviations from Henry's law. At 30 °C, the measured values were $k_{H,B} = 385.5$ bar and $A = 2.24 \times 10^4$ bar.

¹⁹Ref. [153]. ²⁰Ref. [171].

- (a) Treat benzene (B) as the solute and find its activity coefficient on a mole fraction basis, $\gamma_{x,B}$, at 30 °C in the solution of composition $x_B = 3.00 \times 10^{-4}$.
- (b) The fugacity of benzene vapor in equilibrium with pure liquid benzene at 30 °C is $f_B^* = 0.1576$ bar. Estimate the mole fraction solubility of liquid benzene in water at this temperature.
- (c) The calculation of $\gamma_{x,B}$ in part (a) treated the benzene as a single solute species with deviations from infinite-dilution behavior. Tucker et al suggested a dimerization model to explain the observed negative deviations from Henry's law. (Classical thermodynamics, of course, cannot prove such a molecular interpretation of observed macroscopic behavior.) The model assumes that there are two solute species, a monomer (M) and a dimer (D), in reaction equilibrium: $2M \rightleftharpoons D$. Let n_B be the total amount of C_6H_6 present in solution, and define the mole fractions

$$x_B \stackrel{\text{def}}{=} \frac{n_B}{n_A + n_B} \approx \frac{n_B}{n_A}$$

$$x_M \stackrel{\text{def}}{=} \frac{n_M}{n_A + n_M + n_D} \approx \frac{n_M}{n_A} \quad x_D \stackrel{\text{def}}{=} \frac{n_D}{n_A + n_M + n_D} \approx \frac{n_D}{n_A}$$

where the approximations are for dilute solution. In the model, the individual monomer and dimer particles behave as solutes in an ideal-dilute solution, with activity coefficients of unity. The monomer is in transfer equilibrium with the gas phase: $x_M = f_B/k_{H,B}$. The equilibrium constant expression (using a mole fraction basis for the solute standard states and setting pressure factors equal to 1) is $K = x_D/x_M^2$. From the relation $n_B = n_M + 2n_D$, and because the solution is very dilute, the expression becomes

$$K = \frac{x_B - x_M}{2x_M^2}$$

Make individual calculations of K from the values of f_B measured at $x_B = 1.00 \times 10^{-4}$, $x_B = 2.00 \times 10^{-4}$, and $x_B = 3.00 \times 10^{-4}$. Extrapolate the calculated values of K to $x_B=0$ in order to eliminate nonideal effects such as higher aggregates. Finally, find the fraction of the benzene molecules present in the dimer form at $x_B = 3.00 \times 10^{-4}$ if this model is correct.

- 12.16** Use data in Appendix H to evaluate the thermodynamic equilibrium constant at 298.15 K for the limestone reaction

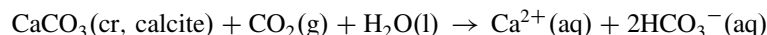

- 12.17** For the dissociation equilibrium of formic acid, $HCO_2H(\text{aq}) \rightleftharpoons H^+(\text{aq}) + HCO_2^-(\text{aq})$, the acid dissociation constant at 298.15 K has the value $K_a = 1.77 \times 10^{-4}$.

- (a) Use Eq. 12.9.7 to find the degree of dissociation and the hydrogen ion molality in a 0.01000 molal formic acid solution. You can safely set Γ_\pm and $\gamma_{m,HA}$ equal to 1, and use the Debye–Hückel limiting law (Eq. 10.4.8) to calculate γ_\pm . You can do this calculation by iteration: Start with an initial estimate of the ionic strength (in this case 0), calculate γ_\pm and α , and repeat these steps until the value of α no longer changes.
- (b) Estimate the degree of dissociation of formic acid in a solution that is 0.01000 molal in both formic acid and sodium nitrate, again using the Debye–Hückel limiting law for γ_\pm . Compare with the value in part (a).

- 12.18** Use the following experimental information to evaluate the standard molar enthalpy of formation and the standard molar entropy of the aqueous chloride ion at 298.15 K, based on the conventions $\Delta_f H^\circ(H^+, \text{aq}) = 0$ and $S_m^\circ(H^+, \text{aq}) = 0$ (Secs. 11.3.2 and 11.8.4). (Your calculated values will be close to, but not exactly the same as, those listed in Appendix H, which are based on the same data combined with data of other workers.)

- For the reaction $\frac{1}{2}\text{H}_2(\text{g}) + \frac{1}{2}\text{Cl}_2(\text{g}) \rightarrow \text{HCl}(\text{g})$, the standard molar enthalpy of reaction at 298.15 K measured in a flow calorimeter²¹ is $\Delta_r H^\circ = -92.312 \text{ kJ mol}^{-1}$.
- The standard molar entropy of gaseous HCl at 298.15 K calculated from spectroscopic data is $S_m^\circ = 186.902 \text{ J K}^{-1} \text{ mol}^{-1}$.
- From five calorimetric runs,²² the average experimental value of the standard molar enthalpy of solution of gaseous HCl at 298.15 K is $\Delta_{\text{sol,B}} H^\circ = -74.84 \text{ kJ mol}^{-1}$.
- From vapor pressure measurements of concentrated aqueous HCl solutions,²³ the value of the ratio $f_B/a_{m,B}$ for gaseous HCl in equilibrium with aqueous HCl at 298.15 K is $5.032 \times 10^{-7} \text{ bar}$.

12.19 The solubility of crystalline AgCl in ultrapure water has been determined from the electrical conductivity of the saturated solution.²⁴ The average of five measurements at 298.15 K is $s_B = 1.337 \times 10^{-5} \text{ mol dm}^{-3}$. The density of water at this temperature is $\rho_A^* = 0.9970 \text{ kg dm}^{-3}$.

- (a) From these data and the Debye–Hückel limiting law, calculate the solubility product K_s of AgCl at 298.15 K.
- (b) Evaluate the standard molar Gibbs energy of formation of aqueous Ag^+ ion at 298.15 K, using the results of part (a) and the values $\Delta_f G^\circ(\text{Cl}^-, \text{aq}) = -131.22 \text{ kJ mol}^{-1}$ and $\Delta_f G^\circ(\text{AgCl}, \text{s}) = -109.77 \text{ kJ mol}^{-1}$ from Appendix H.

12.20 The following reaction was carried out in an adiabatic solution calorimeter by Wagman and Kilday:²⁵

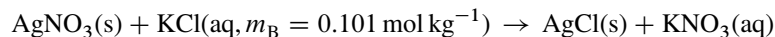

The reaction can be assumed to go to completion, and the amount of KCl was in slight excess, so the amount of AgCl formed was equal to the initial amount of AgNO_3 . After correction for the enthalpies of diluting the solutes in the initial and final solutions to infinite dilution, the standard molar reaction enthalpy at 298.15 K was found to be $\Delta_r H^\circ = -43.042 \text{ kJ mol}^{-1}$. The same workers used solution calorimetry to obtain the molar enthalpy of solution at infinite dilution of crystalline AgNO_3 at 298.15 K: $\Delta_{\text{sol,B}} H^\infty = 22.727 \text{ kJ mol}^{-1}$.

- (a) Show that the difference of these two values is the standard molar reaction enthalpy for the precipitation reaction

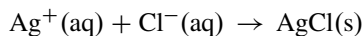

and evaluate this quantity.

- (b) Evaluate the standard molar enthalpy of formation of aqueous Ag^+ ion at 298.15 K, using the results of part (a) and the values $\Delta_f H^\circ(\text{Cl}^-, \text{aq}) = -167.08 \text{ kJ mol}^{-1}$ and $\Delta_f H^\circ(\text{AgCl}, \text{s}) = -127.01 \text{ kJ mol}^{-1}$ from Appendix H. (These values come from calculations similar to those in Probs. 12.18 and 14.4.) The calculated value will be close to, but not exactly the same as, the value listed in Appendix H, which is based on the same data combined with data of other workers.

²¹Ref. [155]. ²²Ref. [77]. ²³Ref. [148]. ²⁴Ref. [72]. ²⁵Ref. [176].

THE PHASE RULE AND PHASE DIAGRAMS

We encountered the Gibbs phase rule and phase diagrams in Chap. 8 in connection with single-substance systems. The present chapter derives the full version of the Gibbs phase rule for multicomponent systems. It then discusses phase diagrams for some representative types of multicomponent systems, and shows how they are related to the phase rule and to equilibrium concepts developed in Chaps. 11 and 12.

13.1 The Gibbs Phase Rule for Multicomponent Systems

In Sec. 8.1.7, the Gibbs phase rule for a pure substance was written $F = 3 - P$. We now consider a system of more than one substance and more than one phase in an equilibrium state. The phase rule assumes the system is at thermal and mechanical equilibrium. We shall assume furthermore that in addition to the temperature and pressure, the only other state functions needed to describe the state are the amounts of the species in each phase; this means for instance that surface effects are ignored.

The derivations to follow will show that the phase rule may be written either in the form

$$F = 2 + C - P \quad (13.1.1)$$

or

$$F = 2 + s - r - P \quad (13.1.2)$$

where the symbols have the following meanings:

F = the number of degrees of freedom (or variance)

= the maximum number of intensive variables that can be varied independently while the system remains in an equilibrium state;

C = the number of components

= the minimum number of substances (or fixed-composition mixtures of substances) that could be used to prepare each phase individually;

P = the number of different phases;

s = the number of different species;

r = the number of independent relations among intensive variables of individual phases other than relations needed for thermal, mechanical, and transfer equilibrium.

If we subdivide a phase, that does not change the number of phases P . That is, we treat noncontiguous regions of the system that have identical intensive properties as parts of the same phase.

13.1.1 Degrees of freedom

Consider a system in an equilibrium state. In this state, the system has one or more phases; each phase contains one or more species; and intensive properties such as T , p , and the mole fraction of a species in a phase have definite values. Starting with the system in this state, we can make changes that place the system in a new equilibrium state having the same kinds of phases and the same species, but different values of some of the intensive properties. The number of different independent intensive variables that we may change in this way is the **number of degrees of freedom** or **variance**, F , of the system.

Clearly, the system remains in equilibrium if we change the *amount* of a phase without changing its temperature, pressure, or composition. This, however, is the change of an extensive variable and is not counted as a degree of freedom.

The phase rule, in the form to be derived, applies to a system that continues to have complete thermal, mechanical, and transfer equilibrium as intensive variables change. This means different phases are not separated by adiabatic or rigid partitions, or by semipermeable or impermeable membranes. Furthermore, every conceivable reaction among the species is either at reaction equilibrium or else is frozen at a fixed advancement during the time period we observe the system.

The number of degrees of freedom is the maximum number of intensive properties of the equilibrium system we may independently vary, or fix at arbitrary values, without causing a change in the number and kinds of phases and species. We cannot, of course, change one of these properties to just any value whatever. We are able to vary the value only within a certain finite (sometimes quite narrow) range before a phase disappears or a new one appears.

The number of degrees of freedom is also the number of independent intensive variables needed to specify the equilibrium state in all necessary completeness, aside from the amount of each phase. In other words, when we specify values of F different independent intensive variables, then the values of all other intensive variables of the equilibrium state have definite values determined by the physical nature of the system.

Just as for a one-component system, we can use the terms *bivariant*, *univariant*, and *invariant* depending on the value of F (Sec. 8.1.7).

13.1.2 Species approach to the phase rule

This section derives an expression for the number of degrees of freedom, F , based on *species*. Section 13.1.3 derives an expression based on *components*. Both approaches yield equivalent versions of the phase rule.

Recall that a *species* is an entity, uncharged or charged, distinguished from other species by its chemical formula (Sec. 9.1.1). Thus, CO_2 and CO_3^{2-} are different species, but $\text{CO}_2(\text{aq})$ and $\text{CO}_2(\text{g})$ is the same species in different phases.

Consider an equilibrium system of P phases, each of which contains the same set of species. Let the number of different species be s . If we could make changes while the system remains in thermal and mechanical equilibrium, but not necessarily in transfer equi-

librium, we could independently vary the temperature and pressure of the system as a whole and the amount of each species in each phase; there would then be $2 + Ps$ independent variables.

The equilibrium system is, however, in transfer equilibrium, which requires each species to have the same chemical potential in each phase: $\mu_i^{\beta} = \mu_i^{\alpha}$, $\mu_i^{\gamma} = \mu_i^{\alpha}$, and so on. There are $P - 1$ independent relations like this for each species, and a total of $s(P - 1)$ independent relations for all species. Each such independent relation introduces a constraint and reduces the number of independent variables by one. Accordingly, taking transfer equilibrium into account, the number of independent variables is $2 + Ps - s(P - 1) = 2 + s$.

We obtain the same result if a species present in one phase is totally excluded from another. For example, solvent molecules of a solution are not found in a pure perfectly-ordered crystal of the solute, undissociated molecules of a volatile strong acid such as HCl can exist in a gas phase but not in aqueous solution, and ions of an electrolyte solute are usually not found in a gas phase. For each such species absent from a phase, there is one fewer amount variable and also one fewer relation for transfer equilibrium; on balance, the number of independent variables is still $2 + s$.

Next, we consider the possibility that further independent relations exist among intensive variables in addition to the relations needed for thermal, mechanical, and transfer equilibrium.¹ If there are r of these additional relations, the total number of independent variables is reduced to $2 + s - r$. These relations may come from

1. reaction equilibria,
2. the requirement of electroneutrality in a phase containing ions, and
3. initial conditions determined by the way the system is prepared.

In the case of a reaction equilibrium, the relation is $\Delta_r G = \sum_i \nu_i \mu_i = 0$, or the equivalent relation $K = \prod_i (a_i)^{\nu_i}$ for the thermodynamic equilibrium constant. Thus, r is the sum of the number of independent reaction equilibria, the number of phases containing ions, and the number of independent initial conditions. Several examples will be given in Sec. 13.1.4.

There is an infinite variety of possible choices of the independent variables (both extensive and intensive) for the equilibrium system, but the total *number* of independent variables is fixed at $2 + s - r$. Keeping intensive properties fixed, we can always vary how much of each phase is present (e.g., its volume, mass, or amount) without destroying the equilibrium. Thus, at least P of the independent variables, one for each phase, must be extensive. It follows that the maximum number of independent *intensive* variables is the difference $(2 + s - r) - P$.

It may be that initial conditions establish relations among the amounts of phases, as will be illustrated in example 2 on page 423. If present, these are relations among *extensive* variables that are not counted in r . Each such independent relation decreases the total number of independent variables without changing the number of independent intensive variables calculated from $(2 + s - r) - P$.

Since the maximum number of independent intensive variables is the number of degrees of freedom, our expression for F based on species is

$$F = 2 + s - r - P \tag{13.1.3}$$

¹Relations such as $\sum_i p_i = p$ for a gas phase or $\sum_i x_i = 1$ for a phase in general have already been accounted for in the derivation by the specification of p and the amount of each species.

13.1.3 Components approach to the phase rule

The derivation of the phase rule in this section uses the concept of **components**. The number of components, C , is the minimum number of substances or mixtures of fixed composition from which we could in principle prepare each individual phase of an equilibrium state of the system, using methods that may be hypothetical. These methods include the addition or removal of one or more of the substances or fixed-composition mixtures, and the conversion of some of the substances into others by means of a reaction that is at equilibrium in the actual system.

It is not always easy to decide on the number of components of an equilibrium system. The number of components may be less than the number of substances present, on account of the existence of reaction equilibria that produce some substances from others. When we use a reaction to prepare a phase, nothing must remain unused. For instance, consider a system consisting of solid phases of CaCO_3 and CaO and a gas phase of CO_2 . Assume the reaction $\text{CaCO}_3(\text{s}) \rightarrow \text{CaO}(\text{s}) + \text{CO}_2(\text{g})$ is at equilibrium. We could prepare the CaCO_3 phase from CaO and CO_2 by the reverse of this reaction, but we can only prepare the CaO and CO_2 phases from the individual substances. We could not use CaCO_3 to prepare either the CaO phase or the CO_2 phase, because CO_2 or CaO would be left over. Thus this system has three substances but only two components, namely CaO and CO_2 .

In deriving the phase rule by the components approach, it is convenient to consider only intensive variables. Suppose we have a system of P phases in which each substance present is a component (i.e., there are no reactions) and each of the C components is present in each phase. If we make changes to the system while it remains in thermal and mechanical equilibrium, but not necessarily in transfer equilibrium, we can independently vary the temperature and pressure of the whole system, and for each phase we can independently vary the mole fraction of all but one of the substances (the value of the omitted mole fraction comes from the relation $\sum_i x_i = 1$). This is a total of $2 + P(C - 1)$ independent intensive variables.

When there also exist transfer and reaction equilibria, not all of these variables are independent. Each substance in the system is either a component, or else can be formed from components by a reaction that is in reaction equilibrium in the system. Transfer equilibria establish $P - 1$ independent relations for each component ($\mu_i^{\beta} = \mu_i^{\alpha}$, $\mu_i^{\gamma} = \mu_i^{\alpha}$, etc.) and a total of $C(P - 1)$ relations for all components. Since these are relations among chemical potentials, which are intensive properties, each relation reduces the number of independent intensive variables by one. The resulting number of independent intensive variables is

$$F = [2 + P(C - 1)] - C(P - 1) = 2 + C - P \quad (13.1.4)$$

If the equilibrium system lacks a particular component in one phase, there is one fewer mole fraction variable and one fewer relation for transfer equilibrium. These changes cancel in the calculation of F , which is still equal to $2 + C - P$. If a phase contains a substance that is formed from components by a reaction, there is an additional mole fraction variable and also the additional relation $\sum_i \nu_i \mu_i = 0$ for the reaction; again the changes cancel.

We may need to *remove* a component from a phase to achieve the final composition. Note that it is not necessary to consider additional relations for electroneutrality or initial conditions; they are implicit in the definitions of the components. For instance, since each component is a substance of zero electric charge, the electrical neutrality of the phase is assured.

We conclude that, regardless of the kind of system, the expression for F based on components is given by $F = 2 + C - P$. By comparing this expression and $F = 2 + s - r - P$, we see that the number of components is related to the number of species by

$$C = s - r \quad (13.1.5)$$

13.1.4 Examples

The five examples below illustrate various aspects of using the phase rule.

Example 1: liquid water

For a single phase of pure water, P equals 1. If we treat the water as the single species H_2O , s is 1 and r is 0. The phase rule then predicts two degrees of freedom:

$$\begin{aligned} F &= 2 + s - r - P \\ &= 2 + 1 - 0 - 1 = 2 \end{aligned} \quad (13.1.6)$$

Since F is the number of intensive variables that can be varied independently, we could for instance vary T and p independently, or T and ρ , or any other pair of independent intensive variables.

Next let us take into account the proton transfer equilibrium

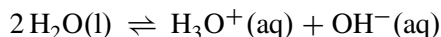

and consider the system to contain the three species H_2O , H_3O^+ , and OH^- . Then for the species approach to the phase rule, we have $s = 3$. We can write two independent relations:

1. for reaction equilibrium, $-2\mu_{\text{H}_2\text{O}} + \mu_{\text{H}_3\text{O}^+} + \mu_{\text{OH}^-} = 0$;
2. for electroneutrality, $m_{\text{H}_3\text{O}^+} = m_{\text{OH}^-}$.

Thus, we have two relations involving intensive variables only. Now s is 3, r is 2, P is 1, and the number of degrees of freedom is given by

$$F = 2 + s - r - P = 2 \quad (13.1.7)$$

which is the same value of F as before.

If we consider water to contain additional cation species (e.g., H_5O_2^+), each such species would add 1 to s and 1 to r , but F would remain equal to 2. Thus, no matter how complicated are the equilibria that actually exist in liquid water, the number of degrees of freedom remains 2.

Applying the components approach to water is simple. All species that may exist in pure water are formed, in whatever proportions actually exist, from the single substance H_2O . Thus, there is only one component: $C = 1$. The component version of the phase rule, $F = 2 + C - P$, gives the same result as the species version: $F = 2$.

Example 2: carbon, oxygen, and carbon oxides

Consider a system containing solid carbon (graphite) and a gaseous mixture of O_2 , CO , and CO_2 . There are four species and two phases. If reaction equilibrium is absent, as might be the case at low temperature in the absence of a catalyst, we have $r = 0$ and $C = s - r = 4$.

The four components are the four substances. The phase rule tells us the system has four degrees of freedom. We could, for instance, arbitrarily vary T , p , y_{O_2} , and y_{CO} .

Now suppose we raise the temperature or introduce an appropriate catalyst to allow the following reaction equilibria to exist:

1. $2\text{C}(\text{s}) + \text{O}_2(\text{g}) \rightleftharpoons 2\text{CO}(\text{g})$
2. $\text{C}(\text{s}) + \text{O}_2(\text{g}) \rightleftharpoons \text{CO}_2(\text{g})$

These equilibria introduce two new independent relations among chemical potentials and among activities. We could also consider the equilibrium $2\text{CO}(\text{g}) + \text{O}_2(\text{g}) \rightleftharpoons 2\text{CO}_2(\text{g})$, but it does not contribute an additional independent relation because it depends on the other two equilibria: the reaction equation is obtained by subtracting the reaction equation for equilibrium 1 from twice the reaction equation for equilibrium 2. By the species approach, we have $s = 4$, $r = 2$, and $P = 2$; the number of degrees of freedom from these values is

$$F = 2 + s - r - P = 2 \quad (13.1.8)$$

If we wish to calculate F by the components approach, we must decide on the minimum number of substances we could use to prepare each phase separately. (This does not refer to how we actually prepare the two-phase system, but to a hypothetical preparation of each phase with any of the compositions that can actually exist in the equilibrium system.) Assume equilibria 1 and 2 are present. We prepare the solid phase with carbon, and we can prepare any possible equilibrium composition of the gas phase from carbon and O_2 by using the reactions of both equilibria. Thus, there are two components (C and O_2) giving the same result of two degrees of freedom.

What is the significance of there being two degrees of freedom when the reaction equilibria are present? There are two ways of viewing the situation:

1. We can arbitrarily vary the two intensive variables T and p . When we do, the mole fractions of the three substances in the gas phase change in a way determined by equilibria 1 and 2.
2. If we specify arbitrary values of T and p , each of the mole fractions has only one possible value that will allow the two phases and four substances to be in equilibrium.

Now to introduce an additional complexity: Suppose we prepare the system by placing a certain amount of O_2 and twice this amount of carbon in an evacuated container, and wait for the reactions to come to equilibrium. This method of preparation imposes an initial condition on the system, and we must decide whether the number of degrees of freedom is affected. Equating the total amount of carbon atoms to the total amount of oxygen atoms in the equilibrated system gives the relation

$$n_{\text{C}} + n_{\text{CO}} + n_{\text{CO}_2} = 2n_{\text{O}_2} + n_{\text{CO}} + 2n_{\text{CO}_2} \quad \text{or} \quad n_{\text{C}} = 2n_{\text{O}_2} + n_{\text{CO}_2} \quad (13.1.9)$$

Either equation is a relation among extensive variables of the two phases. From them, we are unable to obtain any relation among *intensive* variables of the phases. Therefore, this particular initial condition does not change the value of r , and F remains equal to 2.

Example 3: a solid salt and saturated aqueous solution

In this example, the equilibrium system consists of crystalline PbCl_2 and an aqueous phase containing the species H_2O , $\text{Pb}^{2+}(\text{aq})$, and $\text{Cl}^{-}(\text{aq})$.

Applying the components approach to this system is straightforward. The solid phase is prepared from PbCl_2 and the aqueous phase could be prepared by dissolving solid PbCl_2 in H_2O . Thus, there are two components and two phases:

$$F = 2 + C - P = 2 \quad (13.1.10)$$

For the species approach, we note that there are four species (PbCl_2 , Pb^{2+} , Cl^- , and H_2O) and two independent relations among intensive variables:

1. equilibrium for the dissolution process, $-\mu_{\text{PbCl}_2} + \mu_{\text{Pb}^{2+}} + 2\mu_{\text{Cl}^-} = 0$;
2. electroneutrality of the aqueous phase, $2m_{\text{Pb}^{2+}} = m_{\text{Cl}^-}$.

We have $s = 4$, $r = 2$, and $P = 2$, giving the same result as the components approach:

$$F = 2 + s - r - P = 2 \quad (13.1.11)$$

Example 4: liquid water and water-saturated air

For simplicity, let “air” be a gaseous mixture of N_2 and O_2 . The equilibrium system in this example has two phases: liquid water saturated with the dissolved constituents of air, and air saturated with gaseous H_2O .

If there is no special relation among the total amounts of N_2 and O_2 , there are three components and the phase rule gives

$$F = 2 + C - P = 3 \quad (13.1.12)$$

Since there are three degrees of freedom, we could, for instance, specify arbitrary values² of T , p , and y_{N_2} ; then the values of other intensive variables such as the mole fractions $y_{\text{H}_2\text{O}}$ and x_{N_2} would have definite values.

Now suppose we impose an initial condition by preparing the system with water and dry air of a *fixed* composition. The mole ratio of N_2 and O_2 in the aqueous solution is not necessarily the same as in the equilibrated gas phase; consequently, the air does not behave like a single substance. The number of components is still three: H_2O , N_2 , and O_2 are all required to prepare each phase individually, just as when there was no initial condition, giving $F = 3$ as before.³

We can reach the same conclusion with the species approach. The initial condition can be expressed by an equation such as

$$\frac{(n_{\text{N}_2}^{\text{l}} + n_{\text{N}_2}^{\text{g}})}{(n_{\text{O}_2}^{\text{l}} + n_{\text{O}_2}^{\text{g}})} = a \quad (13.1.13)$$

where a is a constant equal to the mole ratio of N_2 and O_2 in the dry air. This equation cannot be changed to a relation between intensive variables such as x_{N_2} and x_{O_2} , so that r is zero and there are still three degrees of freedom.

Finally, let us assume that we prepare the system with dry air of fixed composition, as before, but consider the solubilities of N_2 and O_2 in water to be negligible. Then $n_{\text{N}_2}^{\text{l}}$ and

²Arbitrary, that is, within the limits that would allow the two phases to coexist.

³The fact that the compositions of both phases depend on the relative amounts of the phases is illustrated in Prob. 9.5.

$n_{\text{O}_2}^l$ are zero and Eq. 13.1.13 becomes $n_{\text{N}_2}^g/n_{\text{O}_2}^g = a$, or $y_{\text{N}_2} = ay_{\text{O}_2}$, which is a relation between intensive variables. In this case, r is 1 and the phase rule becomes

$$F = 2 + s - r - P = 2 \quad (13.1.14)$$

The reduction in the value of F from 3 to 2 is a consequence of our inability to detect any dissolved N_2 or O_2 . According to the components approach, we may prepare the liquid phase with H_2O and the gas phase with H_2O and air of fixed composition that behaves as a single substance; thus, there are only two components.

Example 5: equilibrium between two solid phases and a gas phase

Consider the following reaction equilibrium:

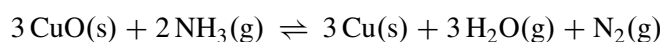

According to the species approach, there are five species, one relation (for reaction equilibrium), and three phases. The phase rule gives

$$F = 2 + s - r - P = 3 \quad (13.1.15)$$

It is more difficult to apply the components approach to this example. As components, we might choose CuO and Cu (from which we could prepare the solid phases) and also NH_3 and H_2O . Then to obtain the N_2 needed to prepare the gas phase, we could use CuO and NH_3 as reactants in the reaction $3 \text{CuO} + 2 \text{NH}_3 \rightarrow 3 \text{Cu} + 3 \text{H}_2\text{O} + \text{N}_2$ and remove the products Cu and H_2O . In the components approach, we are allowed to remove substances from the system provided they are counted as components.

13.2 Phase Diagrams: Binary Systems

As explained in Sec. 8.2, a phase diagram is a kind of two-dimensional map that shows which phase or phases are stable under a given set of conditions. This section discusses some common kinds of binary systems, and Sec. 13.3 will describe some interesting ternary systems.

13.2.1 Generalities

A binary system has two components; C equals 2, and the number of degrees of freedom is $F = 4 - P$. There must be at least one phase, so the maximum possible value of F is 3. Since F cannot be negative, the equilibrium system can have no more than four phases.

We can independently vary the temperature, pressure, and composition of the system as a whole. Instead of using these variables as the coordinates of a three-dimensional phase diagram, we usually draw a two-dimensional phase diagram that is either a temperature–composition diagram at a fixed pressure or a pressure–composition diagram at a fixed temperature. The position of the system point on one of these diagrams then corresponds to a definite temperature, pressure, and overall composition. The composition variable usually varies along the horizontal axis and can be the mole fraction, mass fraction, or mass percent of one of the components, as will presently be illustrated by various examples.

The way in which we interpret a two-dimensional phase diagram to obtain the compositions of individual phases depends on the number of phases present in the system.

- If the system point falls within a *one-phase* area of the phase diagram, the composition variable is the composition of that single phase. There are three degrees of freedom. On the phase diagram, the value of either T or p has been fixed, so there are two other independent intensive variables. For example, on a temperature–composition phase diagram, the pressure is fixed and the temperature and composition can be changed independently within the boundaries of the one-phase area of the diagram.
- If the system point is in a *two-phase* area of the phase diagram, we draw a horizontal *tie line* of constant temperature (on a temperature–composition phase diagram) or constant pressure (on a pressure–composition phase diagram). The lever rule applies. The position of the point at each end of the tie line, at the boundary of the two-phase area, gives the value of the composition variable of one of the phases and also the physical state of this phase: either the state of an adjacent one-phase area, or the state of a phase of fixed composition when the boundary is a vertical line. Thus, a boundary that separates a two-phase area for phases α and β from a one-phase area for phase α is a curve that describes the composition of phase α as a function of T or p when it is in equilibrium with phase β . The curve is called a *solidus*, *liquidus*, or *vaporus* depending on whether phase α is a solid, liquid, or gas.
- A binary system with *three* phases has only one degree of freedom and cannot be represented by an area on a two-dimensional phase diagram. Instead, there is a horizontal boundary line between areas, with a special point along the line at the junction of several areas. The compositions of the three phases are given by the positions of this point and the points at the two ends of the line. The position of the system point on this line does not uniquely specify the relative amounts in the three phases.

The examples that follow show some of the simpler kinds of phase diagrams known for binary systems.

13.2.2 Solid–liquid systems

Figure 13.1 on the next page is a temperature–composition phase diagram at a fixed pressure. The composition variable z_B is the mole fraction of component B in the system as a whole. The phases shown are a binary liquid mixture of A and B, pure solid A, and pure solid B.

The one-phase liquid area is bounded by two curves, which we can think of either as freezing-point curves for the liquid or as solubility curves for the solids. These curves comprise the liquidus. As the mole fraction of either component in the liquid phase decreases from unity, the freezing point decreases. The curves meet at point a, which is a **eutectic point**. At this point, both solid A and solid B can coexist in equilibrium with a binary liquid mixture. The composition at this point is the *eutectic composition*, and the temperature here (denoted T_e) is the *eutectic temperature*. T_e is the lowest temperature for the given pressure at which the liquid phase is stable.⁴

Suppose we combine 0.60 mol A and 0.40 mol B ($z_B = 0.40$) and adjust the temperature so as to put the system point at b. This point is in the one-phase liquid area, so the equilibrium system at this temperature has a single liquid phase. If we now place the system in thermal contact with a cold reservoir, heat is transferred out of the system and the system

⁴“Eutectic” comes from the Greek for *easy melting*.

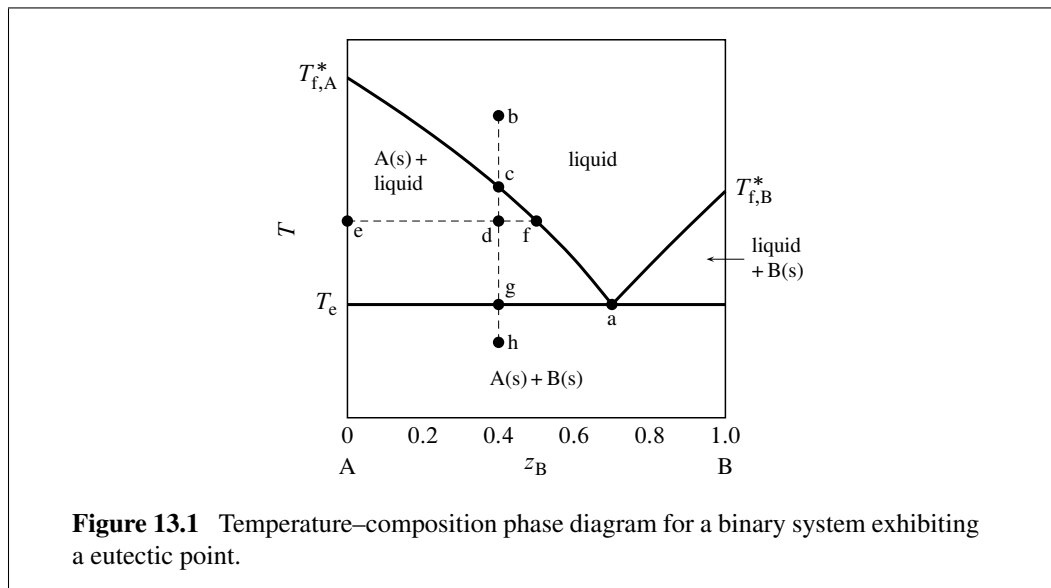

point moves down along the *isopleth* (path of constant overall composition) b–h. The cooling rate depends on the temperature gradient at the system boundary and the system’s heat capacity.

At point c on the isopleth, the system point reaches the boundary of the one-phase area and is about to enter the two-phase area labeled A(s) + liquid. At this point in the cooling process, the liquid is saturated with respect to solid A, and solid A is about to freeze out from the liquid. There is an abrupt decrease (break) in the cooling rate at this point, because the freezing process involves an extra enthalpy decrease.

At the still lower temperature at point d, the system point is within the two-phase solid–liquid area. The tie line through this point is line e–f. The compositions of the two phases are given by the values of z_B at the ends of the tie line: $x_B^s = 0$ for the solid and $x_B^l = 0.50$ for the liquid. From the general lever rule (Eq. 8.2.8 on page 211), the ratio of the amounts in these phases is

$$\frac{n^l}{n^s} = \frac{z_B - x_B^s}{x_B^l - z_B} = \frac{0.40 - 0}{0.50 - 0.40} = 4.0 \quad (13.2.1)$$

Since the total amount is $n^s + n^l = 1.00$ mol, the amounts of the two phases must be $n^s = 0.20$ mol and $n^l = 0.80$ mol.

When the system point reaches the eutectic temperature at point g, cooling halts until all of the liquid freezes. Solid B freezes out as well as solid A. During this *eutectic halt*, there are at first three phases: liquid with the eutectic composition, solid A, and solid B. As heat continues to be withdrawn from the system, the amount of liquid decreases and the amounts of the solids increase until finally only 0.60 mol of solid A and 0.40 mol of solid B are present. The temperature then begins to decrease again and the system point enters the two-phase area for solid A and solid B; tie lines in this area extend from $z_B = 0$ to $z_B = 1$.

Temperature–composition phase diagrams such as this are often mapped out experimentally by observing the cooling curve (temperature as a function of time) along isopleths of various compositions. This procedure is *thermal analysis*. A break in the slope of a cooling curve at a particular temperature indicates the system point has moved from a one-phase

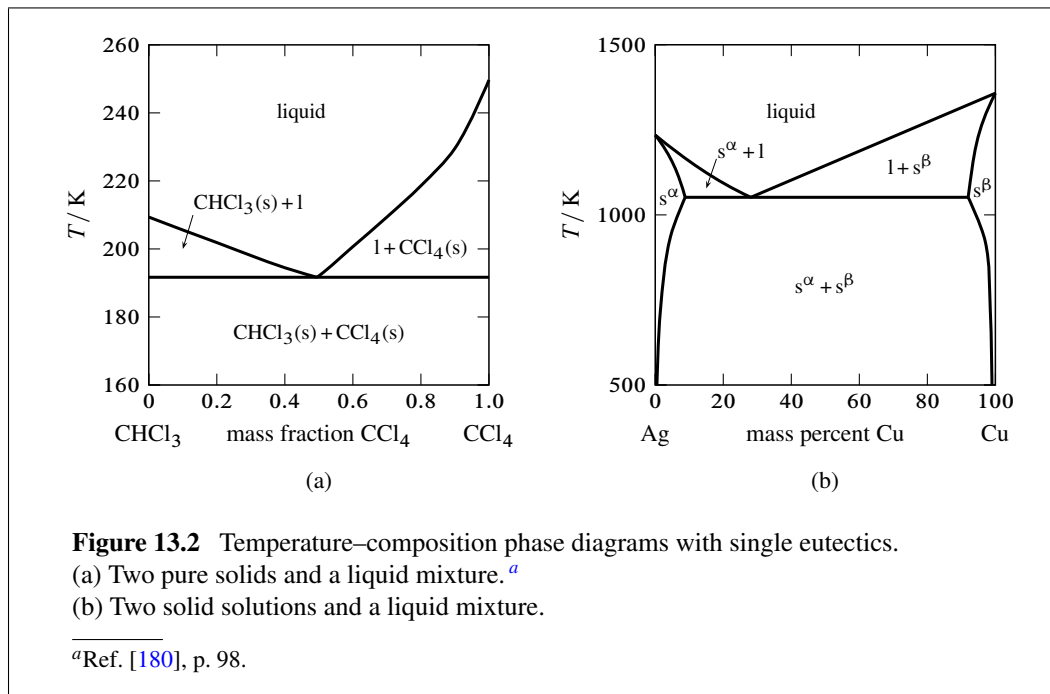

liquid area to a two-phase area of liquid and solid. A temperature halt indicates the temperature is either the freezing point of the liquid to form a solid of the same composition, or else a eutectic temperature.

Figure 13.2 shows two temperature–composition phase diagrams with single eutectic points. The left-hand diagram is for the binary system of chloroform and carbon tetrachloride, two liquids that form nearly ideal mixtures. The solid phases are pure crystals, as in Fig. 13.1. The right-hand diagram is for the silver–copper system and involves solid phases that are solid solutions (substitutional alloys of variable composition). The area labeled s^α is a solid solution that is mostly silver, and s^β is a solid solution that is mostly copper. The lines in the two-phase areas do not end at a vertical line for a pure solid component as they do in the system shown in the left-hand diagram. The three phases that can coexist at the eutectic temperature of 1,052 K are the melt of the eutectic composition and the two solid solutions.

Section 12.5.4 discussed the possibility of the appearance of a *solid compound* when a binary liquid mixture is cooled. An example of this behavior is shown in Fig. 13.3 on the next page, in which the solid compound contains equal amounts of the two components α -naphthylamine and phenol. The possible solid phases are pure A, pure B, and the solid compound AB. Only one or two of these solids can be present simultaneously in an equilibrium state. The vertical line in the figure at $z_B = 0.5$ represents the solid compound. The temperature at the upper end of this line is the melting point of the solid compound, 29°C. The solid melts *congruently* to give a liquid of the same composition. A melting process with this behavior is called a *dystectic reaction*. The cooling curve for liquid of this composition would display a halt at the melting point.

The phase diagram in Fig. 13.3 has two eutectic points. It resembles two simple phase diagrams like Fig. 13.1 placed side by side. There is one important difference: the slope of the freezing-point curve (liquidus curve) is nonzero at the composition of a pure component,

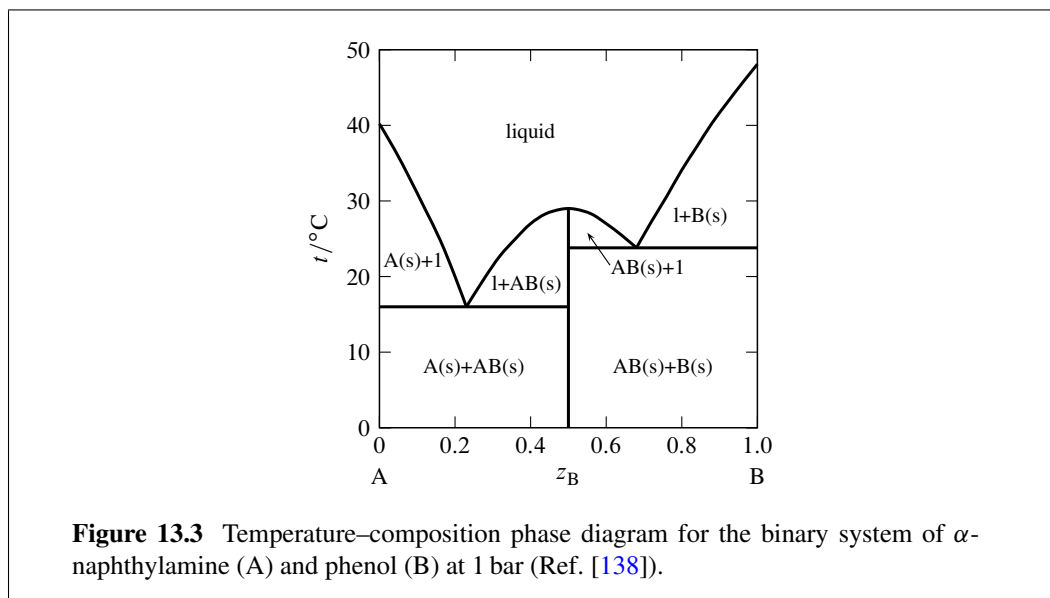

but is zero at the composition of a solid compound that is completely dissociated in the liquid (as derived theoretically on page 389). Thus, the curve in Fig. 13.3 has a relative maximum at the composition of the solid compound ($z_B = 0.5$) and is rounded there, instead of having a cusp—like a Romanesque arch rather than a Gothic arch.

An example of a solid compound that does not melt congruently is shown in Fig. 13.4 on the next page. The solid hydrate $\text{NaCl}\cdot 2\text{H}_2\text{O}$ is 61.9% NaCl by mass. It decomposes at 0°C to form an aqueous solution of composition 26.3% NaCl by mass and a solid phase of anhydrous NaCl. These three phases can coexist at equilibrium at 0°C . A phase transition like this, in which a solid compound changes into a liquid and a different solid, is called *incongruent* or *peritectic* melting, and the point on the phase diagram at this temperature at the composition of the liquid is a *peritectic point*.

Figure 13.4 shows there are two other temperatures at which three phases can be present simultaneously: -21°C , where the phases are ice, the solution at its eutectic point, and the solid hydrate; and 109°C , where the phases are gaseous H_2O , a solution of composition 28.3% NaCl by mass, and solid NaCl. Note that both segments of the right-hand boundary of the one-phase solution area have positive slopes, meaning that the solubilities of the solid hydrate and the anhydrous salt both increase with increasing temperature.

13.2.3 Partially-miscible liquids

When two liquids that are partially miscible are combined in certain proportions, phase separation occurs (Sec. 11.1.6). Two liquid phases in equilibrium with one another are called *conjugate phases*. Obviously the two phases must have different compositions or they would be identical; the difference is called a *miscibility gap*. A binary system with two phases has two degrees of freedom, so that at a given temperature and pressure each conjugate phase has a fixed composition.

The typical dependence of a miscibility gap on temperature is shown in Fig. 13.5 on page 431. The miscibility gap (the difference in compositions at the left and right boundaries of the two-phase area) decreases as the temperature increases until at the *upper conso-*

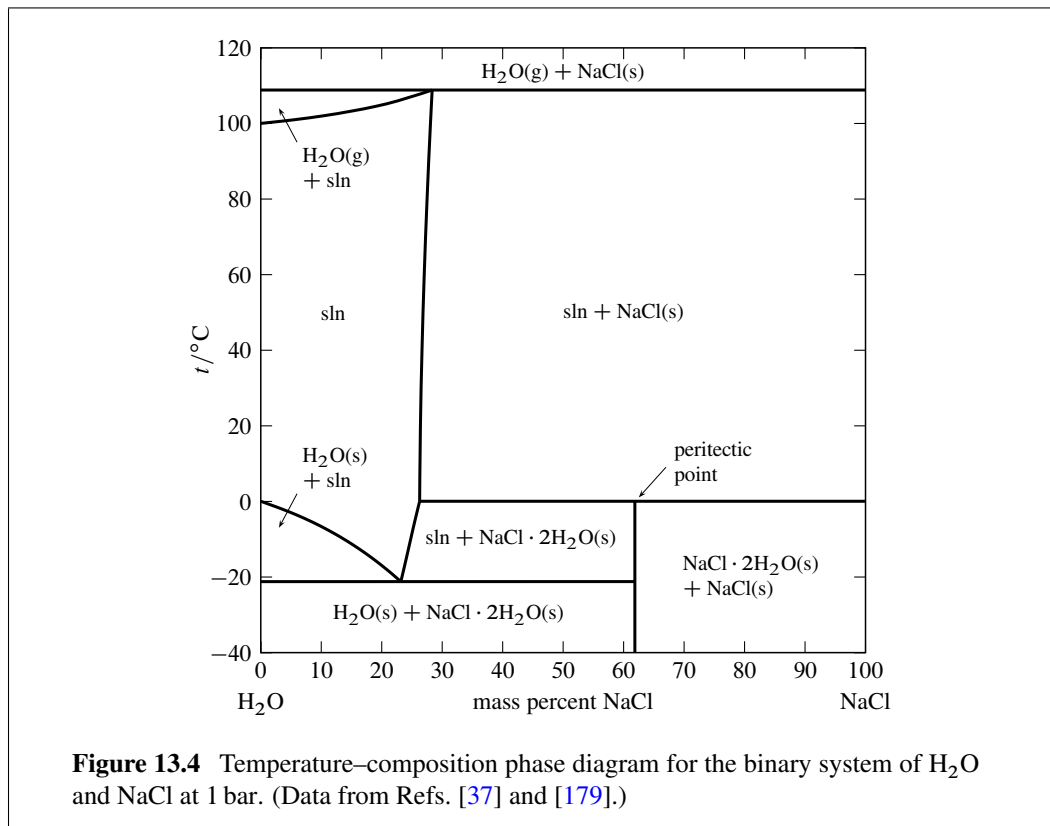

lute temperature, also called the *upper critical solution temperature*, the gap vanishes. The point at the maximum of the boundary curve of the two-phase area, where the temperature is the upper consolute temperature, is the *consolute point* or *critical point*. At this point, the two liquid phases become identical, just as the liquid and gas phases become identical at the critical point of a pure substance. Critical opalescence (page 207) is observed in the vicinity of this point, caused by large local composition fluctuations. At temperatures at and above the critical point, the system is a single binary liquid mixture.

Suppose we combine 6.0 mol of component A (methyl acetate) and 4.0 mol of component B (carbon disulfide) in a cylindrical vessel and adjust the temperature to 200 K. The overall mole fraction of B is $z_B = 0.40$. The system point is at point a in the two-phase region. From the positions of points b and c at the ends of the tie line through point a, we find the two liquid layers have compositions $x_B^\alpha = 0.20$ and $x_B^\beta = 0.92$. Since carbon disulfide is the more dense of the two pure liquids, the bottom layer is phase β , the layer that is richer in carbon disulfide. According to the lever rule, the ratio of the amounts in the two phases is given by

$$\frac{n^\beta}{n^\alpha} = \frac{z_B - x_B^\alpha}{x_B^\beta - z_B} = \frac{0.40 - 0.20}{0.92 - 0.40} = 0.38 \quad (13.2.2)$$

Combining this value with $n^\alpha + n^\beta = 10.0$ mol gives us $n^\alpha = 7.2$ mol and $n^\beta = 2.8$ mol.

If we gradually add more carbon disulfide to the vessel while gently stirring and keeping the temperature constant, the system point moves to the right along the tie line. Since the ends of this tie line have fixed positions, neither phase changes its composition, but the

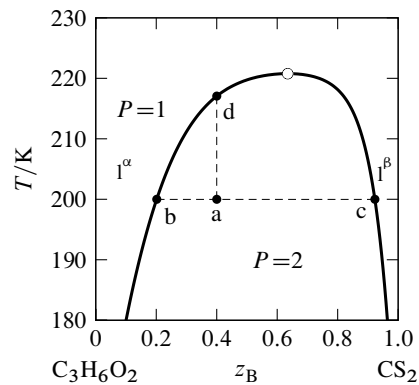

Figure 13.5 Temperature–composition phase diagram for the binary system of methyl acetate (A) and carbon disulfide (B) at 1 bar. ^a All phases are liquids. The open circle indicates the critical point.

^aData from Ref. [57].

amount of phase β increases at the expense of phase α . The liquid–liquid interface moves up in the vessel toward the top of the liquid column until, at overall composition $z_B = 0.92$ (point c), there is only one liquid phase.

Now suppose the system point is back at point a and we raise the temperature while keeping the overall composition constant at $z_B = 0.40$. The system point moves up the isopleth a–d. The phase diagram shows that the ratio $(z_B - x_B^\alpha)/(x_B^\beta - z_B)$ decreases during this change. As a result, the amount of phase α increases, the amount of phase β decreases, and the liquid–liquid interface moves down toward the bottom of the vessel until at 217 K (point d) there again is only one liquid phase.

13.2.4 Liquid–gas systems with ideal liquid mixtures

Toluene and benzene form liquid mixtures that are practically ideal and closely obey Raoult’s law for partial pressure. For the binary system of these components, we can use the vapor pressures of the pure liquids to generate the liquidus and vaporus curves of the pressure–composition and temperature–composition phase diagram. The results are shown in Fig. 13.6 on the next page. The composition variable z_A is the overall mole fraction of component A (toluene).

The equations needed to generate the curves can be derived as follows. Consider a binary liquid mixture of components A and B and mole fraction composition x_A that obeys Raoult’s law for partial pressure (Eq. 9.4.2):

$$p_A = x_A p_A^* \quad p_B = (1 - x_A) p_B^* \quad (13.2.3)$$

Strictly speaking, Raoult’s law applies to a liquid–gas system maintained at a constant pressure by means of a third gaseous component, and p_A^* and p_B^* are the vapor pressures of the pure liquid components at this pressure and the temperature of the system. However, when a liquid phase is equilibrated with a gas phase, the partial pressure of a constituent of the liquid is practically independent of the total pressure (Sec. 12.8.1), so that it is a good

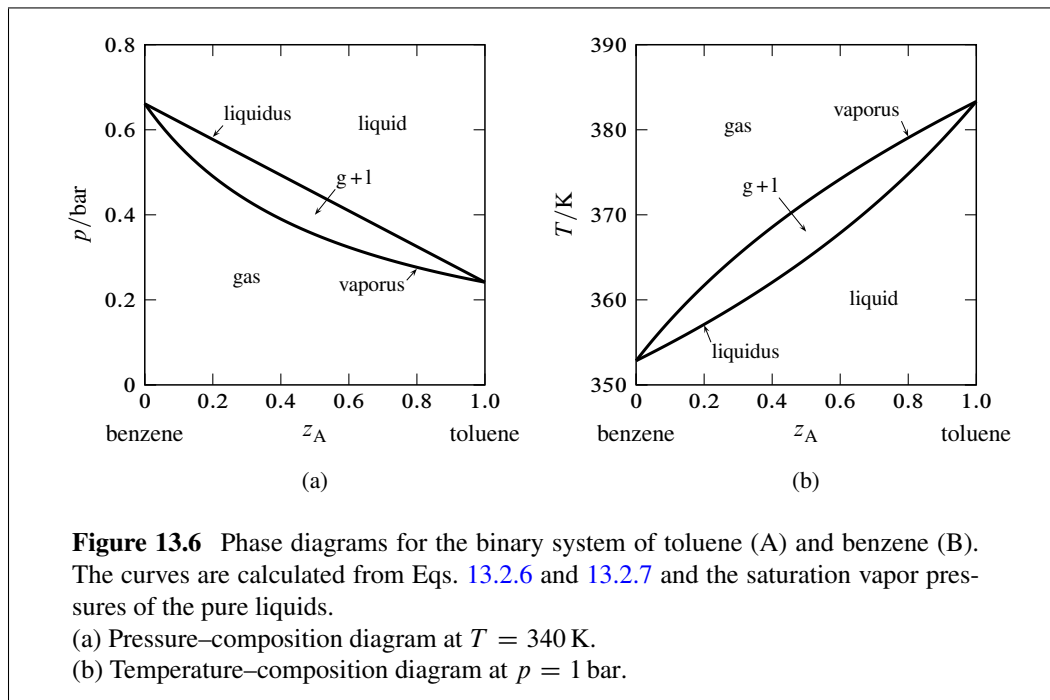

approximation to apply the equations to a *binary* liquid–gas system and treat p_A^* and p_B^* as functions only of T .

When the binary system contains a liquid phase and a gas phase in equilibrium, the pressure is the sum of p_A and p_B , which from Eq. 13.2.3 is given by

$$\begin{aligned} p &= x_A p_A^* + (1 - x_A) p_B^* \\ &= p_B^* + (p_A^* - p_B^*) x_A \end{aligned} \quad (13.2.4)$$

$(C=2, \text{ ideal liquid mixture})$

where x_A is the mole fraction of A in the liquid phase. Equation 13.2.4 shows that in the two-phase system, p has a value between p_A^* and p_B^* , and that if T is constant, p is a linear function of x_A . The mole fraction composition of the gas in the two-phase system is given by

$$y_A = \frac{p_A}{p} = \frac{x_A p_A^*}{p_B^* + (p_A^* - p_B^*) x_A} \quad (13.2.5)$$

A binary two-phase system has two degrees of freedom. At a given T and p , each phase must have a fixed composition. We can calculate the liquid composition by rearranging Eq. 13.2.4:

$$x_A = \frac{p - p_B^*}{p_A^* - p_B^*} \quad (13.2.6)$$

$(C=2, \text{ ideal liquid mixture})$

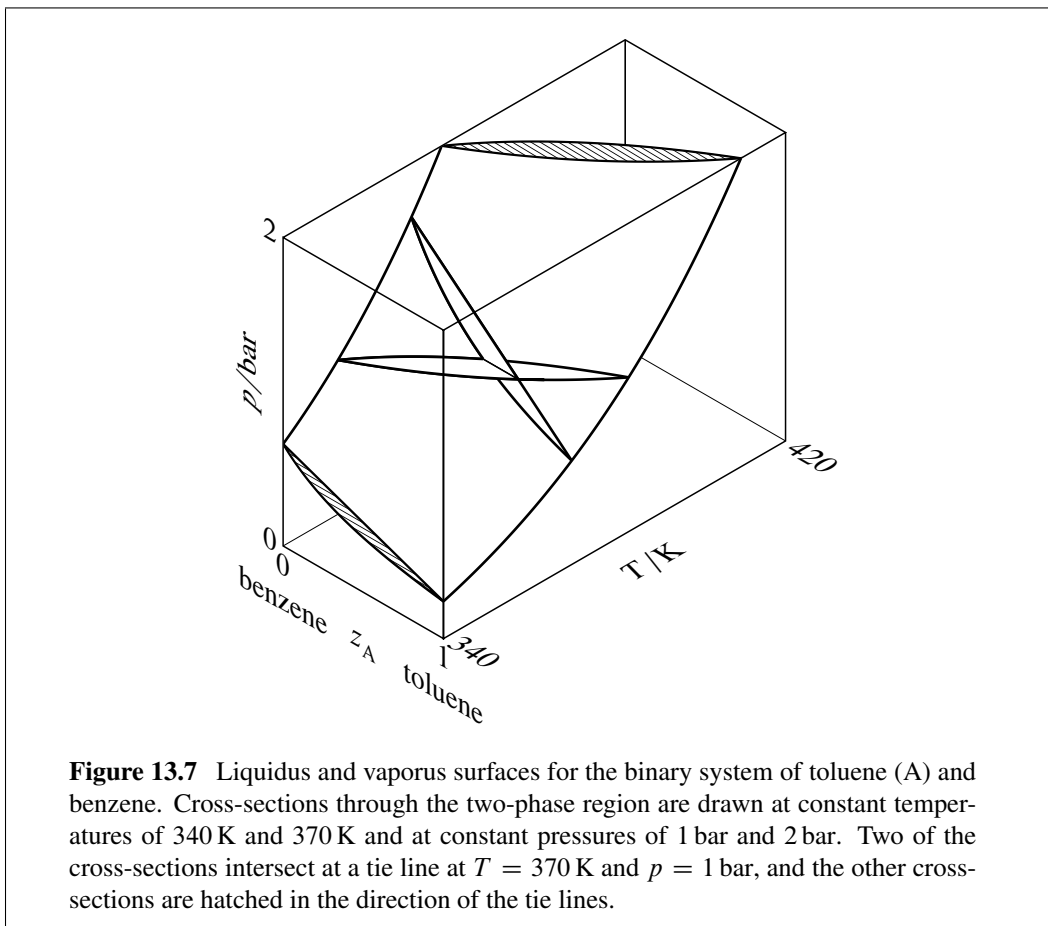

The gas composition is then given by

$$\begin{aligned}
 y_A &= \frac{p_A}{p} = \frac{x_A p_A^*}{p} \\
 &= \left(\frac{p - p_B^*}{p_A^* - p_B^*} \right) \frac{p_A^*}{p} \quad (13.2.7) \\
 &\quad (C=2, \text{ ideal liquid mixture})
 \end{aligned}$$

If we know p_A^* and p_B^* as functions of T , we can use Eqs. 13.2.6 and 13.2.7 to calculate the compositions for any combination of T and p at which the liquid and gas phases can coexist, and thus construct a pressure–composition or temperature–composition phase diagram.

In Fig. 13.6(a), the liquidus curve shows the relation between p and x_A for equilibrated liquid and gas phases at constant T , and the vaporus curve shows the relation between p and y_A under these conditions. We see that p is a linear function of x_A but not of y_A .

In a similar fashion, the liquidus curve in Fig. 13.6(b) shows the relation between T and x_A , and the vaporus curve shows the relation between T and y_A , for equilibrated liquid and gas phases at constant p . Neither curve is linear.

A liquidus curve is also called a *bubble-point* curve or a *boiling-point* curve. Other names for a vaporus curve are *dew-point* curve and *condensation* curve. These curves are actually cross-sections of liquidus and vaporus *surfaces* in a three-dimensional T – p – z_A

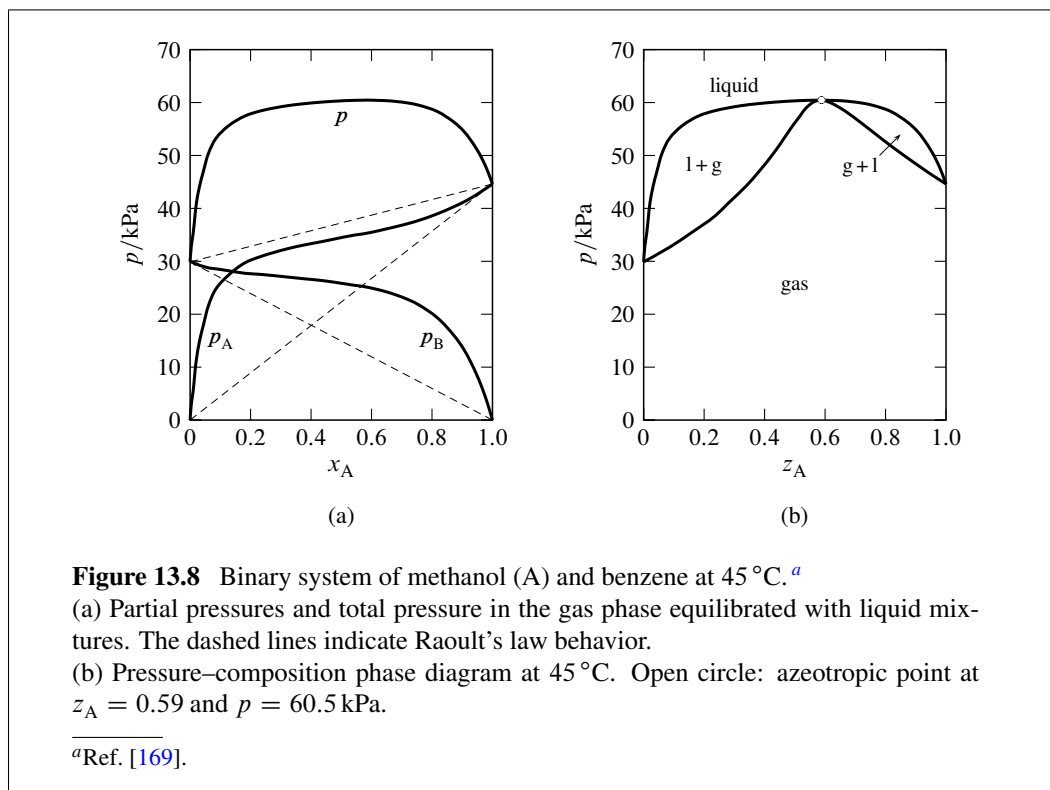

phase diagram, as shown in Fig. 13.7 on the preceding page. In this figure, the liquidus surface is in view at the front and the vaporus surface is hidden behind it.

13.2.5 Liquid–gas systems with nonideal liquid mixtures

Most binary liquid mixtures do not behave ideally. The most common situation is *positive* deviations from Raoult's law.⁵ Some mixtures, however, have specific A–B interactions, such as solvation or molecular association, that prevent random mixing of the molecules of A and B, and the result is then *negative* deviations from Raoult's law. If the deviations from Raoult's law, either positive or negative, are large enough, the constant-temperature liquidus curve exhibits a maximum or minimum and *azeotropic* behavior results.

Figure 13.8 shows the azeotropic behavior of the binary methanol–benzene system at constant temperature. In Fig. 13.8(a), the experimental partial pressures in a gas phase equilibrated with the nonideal liquid mixture are plotted as a function of the liquid composition. The partial pressures of both components exhibit positive deviations from Raoult's law,⁶ and the total pressure (equal to the sum of the partial pressures) has a maximum value greater than the vapor pressure of either pure component. The curve of p versus x_A becomes the liquidus curve of the pressure–composition phase diagram shown in Fig. 13.8(b). Points on the vaporus curve are calculated from $p = p_A/y_A$.

⁵In the molecular model of Sec. 11.1.5, positive deviations correspond to a less negative value of k_{AB} than the average of k_{AA} and k_{BB} . ⁶This behavior is consistent with the statement in Sec. 12.8.2 that if one constituent of a binary liquid mixture exhibits positive deviations from Raoult's law, with only one inflection point in the curve of fugacity versus mole fraction, the other constituent also has positive deviations from Raoult's law.

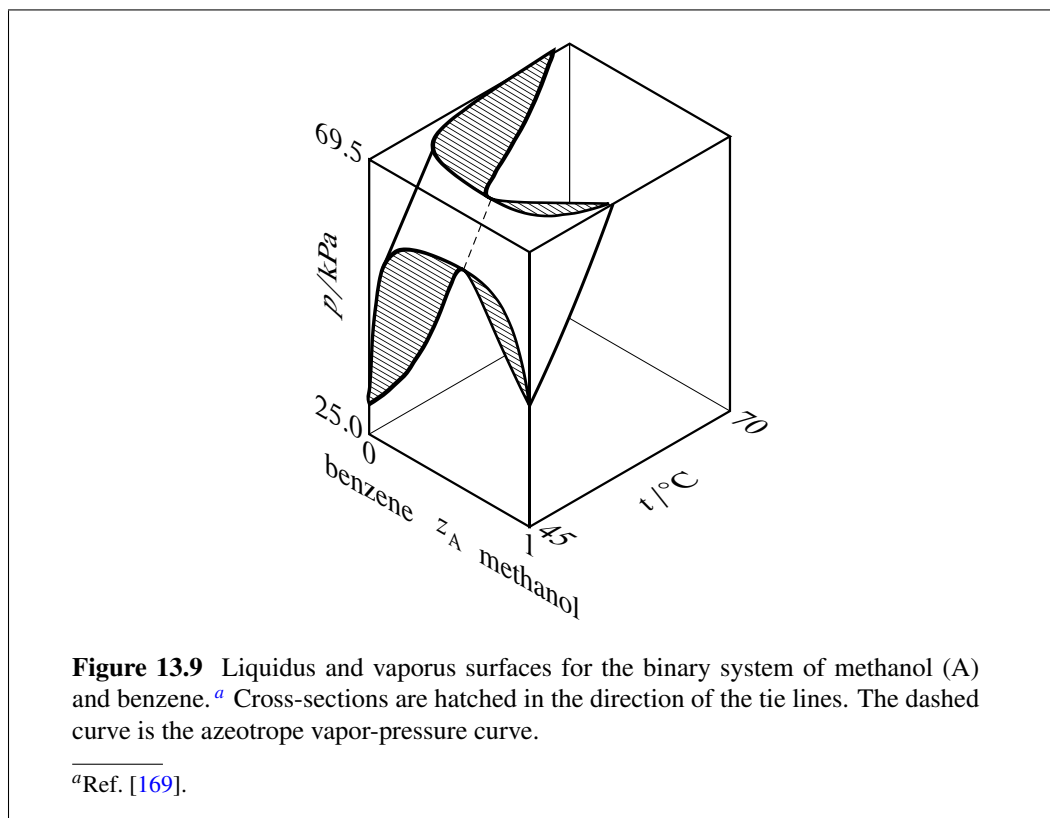

In practice, the data needed to generate the liquidus and vaporus curves of a nonideal binary system are usually obtained by allowing liquid mixtures of various compositions to boil in an equilibrium still at a fixed temperature or pressure. When the liquid and gas phases have become equilibrated, samples of each are withdrawn for analysis. The partial pressures shown in Fig. 13.8(a) were calculated from the experimental gas-phase compositions with the relations $p_A = y_A p$ and $p_B = p - p_A$.

If the constant-temperature liquidus curve has a maximum pressure at a liquid composition not corresponding to one of the pure components, which is the case for the methanol–benzene system, then the liquid and gas phases are mixtures of identical compositions at this pressure. This behavior was deduced on page 405 at the end of Sec. 12.8.3. On the pressure–composition phase diagram, the liquidus and vaporus curves both have maxima at this pressure, and the two curves coincide at an *azeotropic point*. A binary system with negative deviations from Raoult’s law can have an isothermal liquidus curve with a *minimum* pressure at a particular mixture composition, in which case the liquidus and vaporus curves coincide at an azeotropic point at this minimum. The general phenomenon in which equilibrated liquid and gas mixtures have identical compositions is called *azeotropy*, and the liquid with this composition is an azeotropic mixture or **azeotrope** (Greek: *boils unchanged*). An azeotropic mixture vaporizes as if it were a pure substance, undergoing an equilibrium phase transition to a gas of the same composition.

If the liquidus and vaporus curves exhibit a *maximum* on a pressure–composition phase diagram, then they exhibit a *minimum* on a temperature–composition phase diagram. This relation is explained for the methanol–benzene system by the three-dimensional liquidus

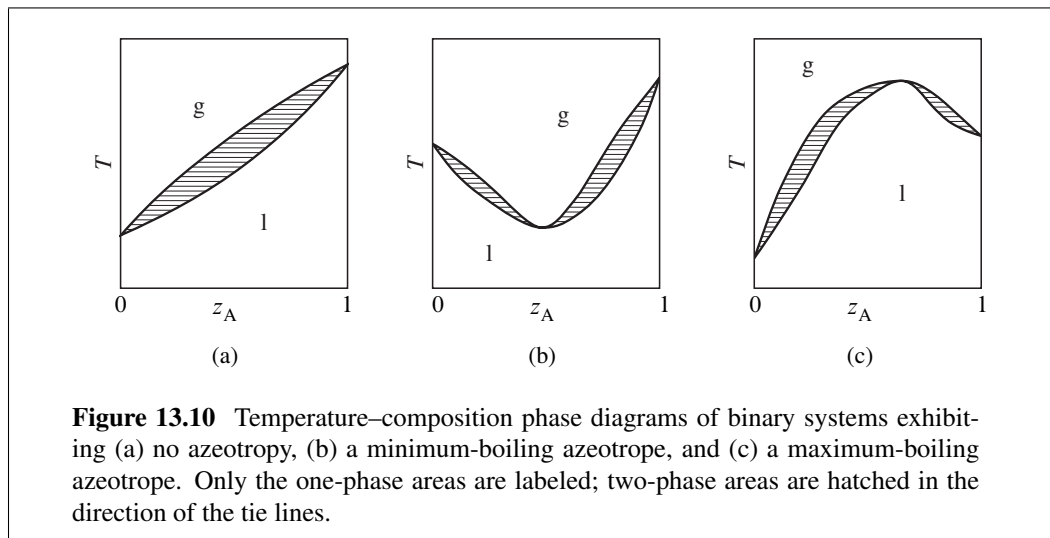

and vaporus surfaces drawn in Fig. 13.9 on the preceding page. In this diagram, the vaporus surface is hidden behind the liquidus surface. The hatched cross-section at the front of the figure is the same as the pressure–composition diagram of Fig. 13.8(b), and the hatched cross-section at the top of the figure is a temperature–composition phase diagram in which the system exhibits a *minimum-boiling azeotrope*.

A binary system containing an azeotropic mixture in equilibrium with its vapor has two species, two phases, and one relation among intensive variables: $x_A = y_A$. The number of degrees of freedom is then $F = 2 + s - r - P = 2 + 2 - 1 - 2 = 1$; the system is univariant. At a given temperature, the azeotrope can exist at only one pressure and have only one composition. As T changes, so do p and z_A along an *azeotrope vapor-pressure curve* as illustrated by the dashed curve in Fig. 13.9.

Figure 13.10 summarizes the general appearance of some relatively simple temperature–composition phase diagrams of binary systems. If the system does not form an azeotrope (*zeotropic* behavior), the equilibrated gas phase is richer in one component than the liquid phase at all liquid compositions, and the liquid mixture can be separated into its two components by fractional distillation. The gas in equilibrium with an azeotropic mixture, however, is not enriched in either component. Fractional distillation of a system with an azeotrope leads to separation into one pure component and the azeotropic mixture.

More complicated behavior is shown in the phase diagrams of Fig. 13.11. These are binary systems with partially-miscible liquids in which the boiling point is reached before an upper consolute temperature can be observed.

13.2.6 Solid–gas systems

As an example of a two-component system with equilibrated solid and gas phases, consider the components CuSO_4 and H_2O , denoted A and B respectively. In the pressure–composition phase diagram shown in Fig. 13.12 on page 438, the composition variable z_B is as usual the mole fraction of component B in the system as a whole.

The anhydrous salt and its hydrates (solid compounds) form the series of solids CuSO_4 , $\text{CuSO}_4 \cdot \text{H}_2\text{O}$, $\text{CuSO}_4 \cdot 3\text{H}_2\text{O}$, and $\text{CuSO}_4 \cdot 5\text{H}_2\text{O}$. In the phase diagram these formulas are

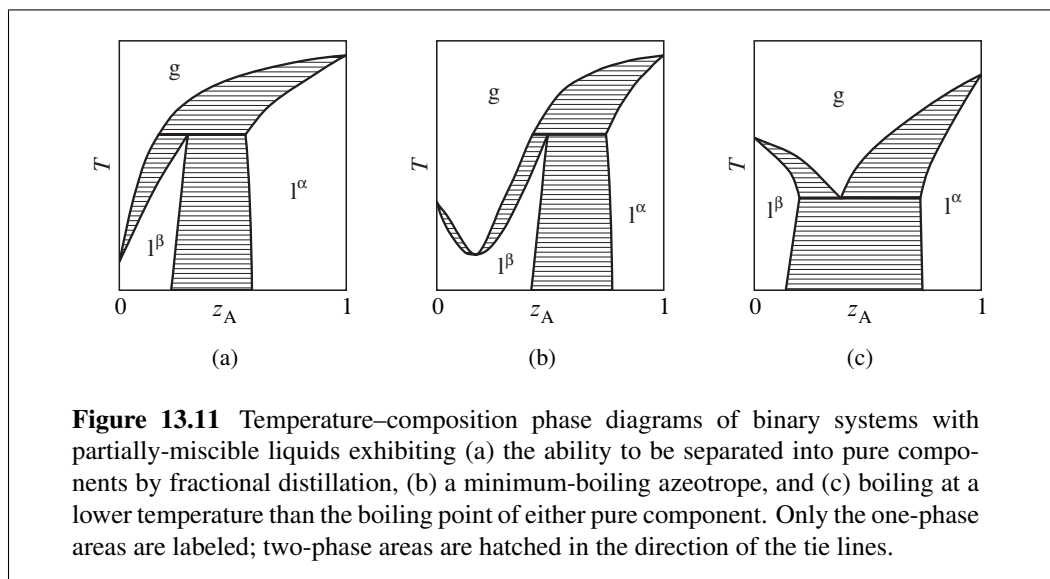
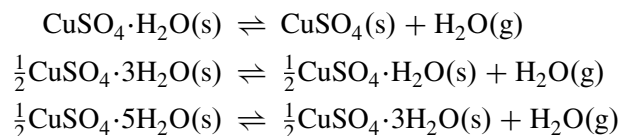

Figure 13.11 Temperature–composition phase diagrams of binary systems with partially-miscible liquids exhibiting (a) the ability to be separated into pure components by fractional distillation, (b) a minimum-boiling azeotrope, and (c) boiling at a lower temperature than the boiling point of either pure component. Only the one-phase areas are labeled; two-phase areas are hatched in the direction of the tie lines.

abbreviated A, AB, AB₃, and AB₅. The following dissociation equilibria (dehydration equilibria) are possible:



The equilibria are written above with coefficients that make the coefficient of H₂O(g) unity. When one of these equilibria is established in the system, there are two components and three phases; the phase rule then tells us the system is univariant and the pressure has only one possible value at a given temperature. This pressure is called the *dissociation pressure* of the higher hydrate.

The dissociation pressures of the three hydrates are indicated by horizontal lines in Fig. 13.12. For instance, the dissociation pressure of CuSO₄·5H₂O is 1.05 × 10^{−2} bar. At the pressure of each horizontal line, the equilibrium system can have one, two, or three phases, with compositions given by the intersections of the line with vertical lines. A fourth three-phase equilibrium is shown at $p = 3.09 \times 10^{-2}$ bar; this is the equilibrium between solid CuSO₄·5H₂O, the saturated aqueous solution of this hydrate, and water vapor.

Consider the thermodynamic equilibrium constant of one of the dissociation reactions. At the low pressures shown in the phase diagram, the activities of the solids are practically unity and the fugacity of the water vapor is practically the same as the pressure, so the equilibrium constant is almost exactly equal to p_d/p° , where p_d is the dissociation pressure of the higher hydrate in the reaction. Thus, a hydrate cannot exist in equilibrium with water vapor at a pressure below the dissociation pressure of the hydrate because dissociation would be spontaneous under these conditions. Conversely, the salt formed by the dissociation of a hydrate cannot exist in equilibrium with water vapor at a pressure above the dissociation pressure because hydration would be spontaneous.

If the system contains dry air as an additional gaseous component and one of the dissociation equilibria is established, the partial pressure $p_{\text{H}_2\text{O}}$ of H₂O is equal (approx-

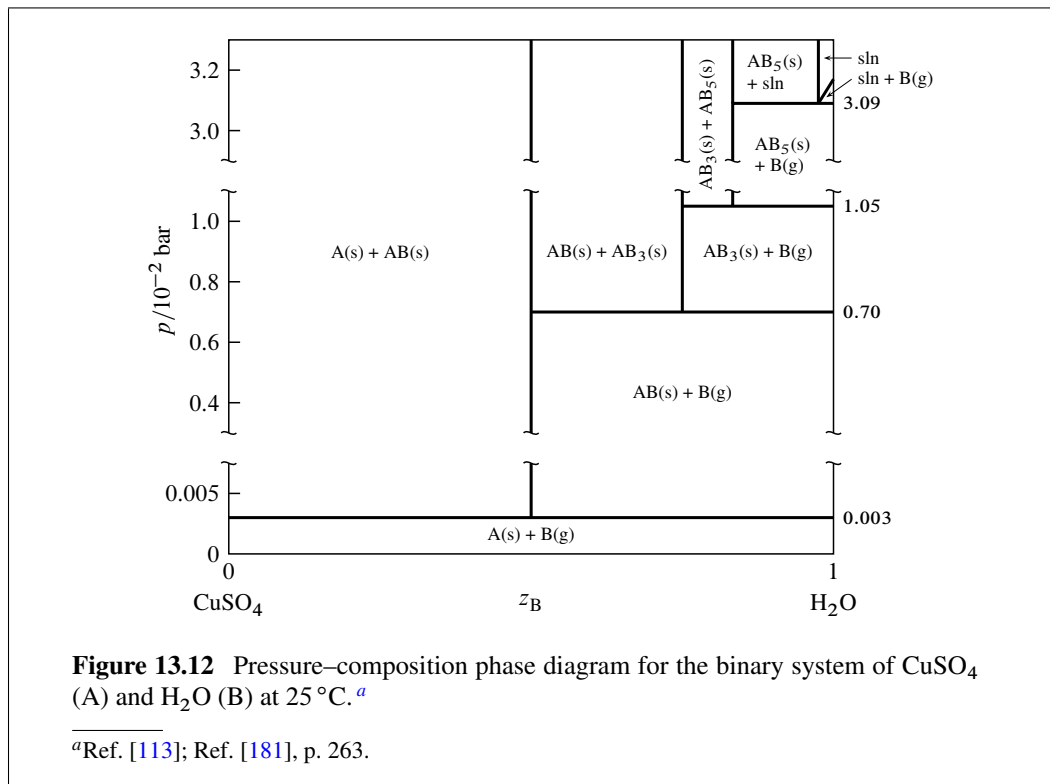

imately) to the dissociation pressure p_d of the higher hydrate. The prior statements regarding dissociation and hydration now depend on the value of $p_{\text{H}_2\text{O}}$. If a hydrate is placed in air in which $p_{\text{H}_2\text{O}}$ is less than p_d , dehydration is spontaneous; this phenomenon is called **efflorescence** (Latin: *blossoming*). If $p_{\text{H}_2\text{O}}$ is greater than the vapor pressure of the saturated solution of the highest hydrate that can form in the system, the anhydrous salt and any of its hydrates will spontaneously absorb water and form the saturated solution; this is **deliquescence** (Latin: *becoming fluid*).

If the two-component equilibrium system contains only two phases, it is bivariant corresponding to one of the areas in Fig. 13.12. Here both the temperature and the pressure can be varied. In the case of areas labeled with two *solid* phases, the pressure has to be applied to the solids by a fluid (other than H_2O) that is not considered part of the system.

13.2.7 Systems at high pressure

Binary phase diagrams begin to look different when the pressure is greater than the critical pressure of either of the pure components. Various types of behavior have been observed in this region. One common type, that found in the binary system of heptane and ethane, is shown in Fig. 13.13 on the next page. This figure shows sections of a three-dimensional phase diagram at five temperatures. Each section is a pressure–composition phase diagram at constant T . The two-phase areas are hatched in the direction of the tie lines. At the left end of each tie line (at low z_A) is a vaporus curve, and at the right end is a liquidus curve. The vapor pressure curve of pure ethane ($z_A=0$) ends at the critical point of ethane at 305.4 K; between this point and the critical point of heptane at 540.5 K, there is a continuous

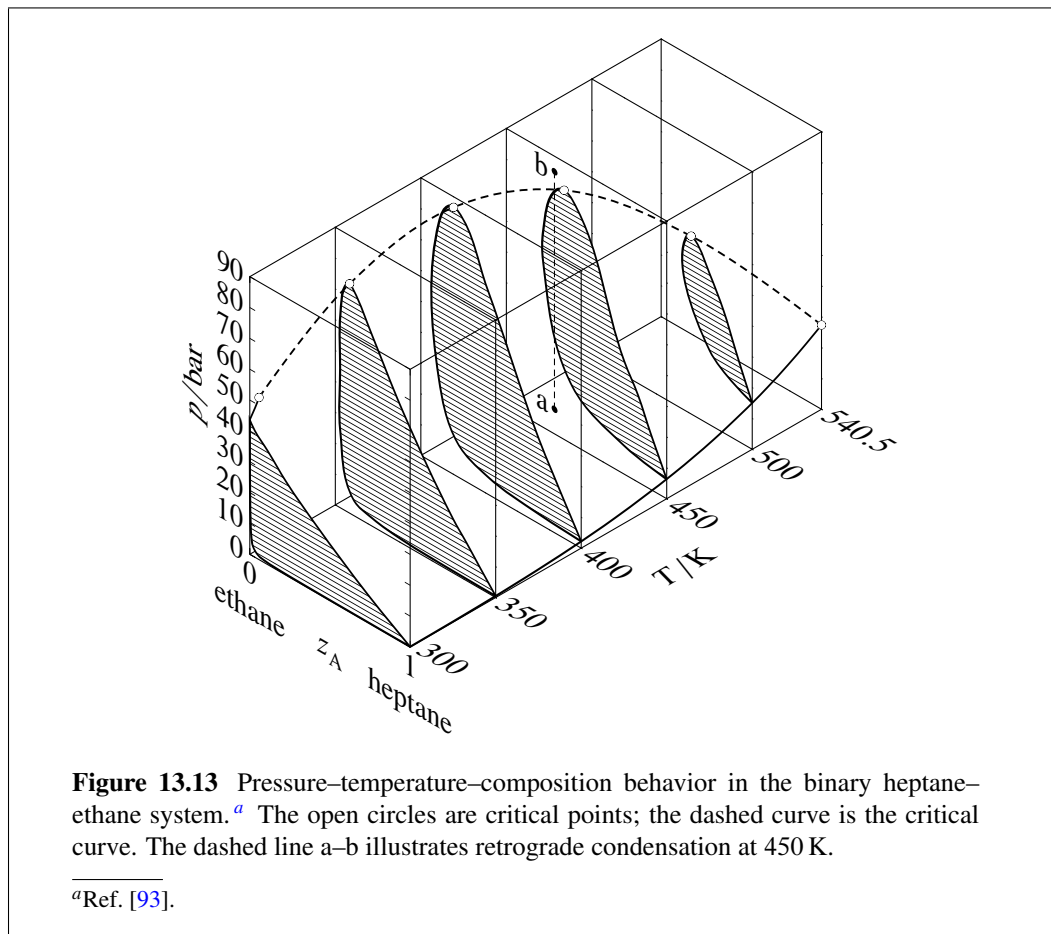

critical curve, which is the locus of critical points at which gas and liquid mixtures become identical in composition and density.

Consider what happens when the system point is at point a in Fig. 13.13 and the pressure is then increased by isothermal compression along line a–b. The system point moves from the area for a gas phase into the two-phase gas–liquid area and then out into the gas-phase area again. This curious phenomenon, condensation followed by vaporization, is called *retrograde condensation*.

Under some conditions, an isobaric increase of T can result in vaporization followed by condensation; this is *retrograde vaporization*.

A different type of high-pressure behavior, that found in the xenon–helium system, is shown in Fig. 13.14 on the next page. Here, the critical curve begins at the critical point of the less volatile component (xenon) and continues to *higher* temperatures and pressures than the critical temperature and pressure of either pure component. The two-phase region at pressures above this critical curve is sometimes said to represent *gas–gas equilibrium*, or *gas–gas immiscibility*, because we would not usually consider a liquid to exist beyond the critical points of the pure components. Of course, the coexisting phases in this two-phase region are not gases in the ordinary sense of being tenuous fluids, but are instead high-pressure fluids of liquid-like densities. If we want to call both phases gases, then we have to say that pure gaseous substances at high pressure do not necessarily mix spontaneously

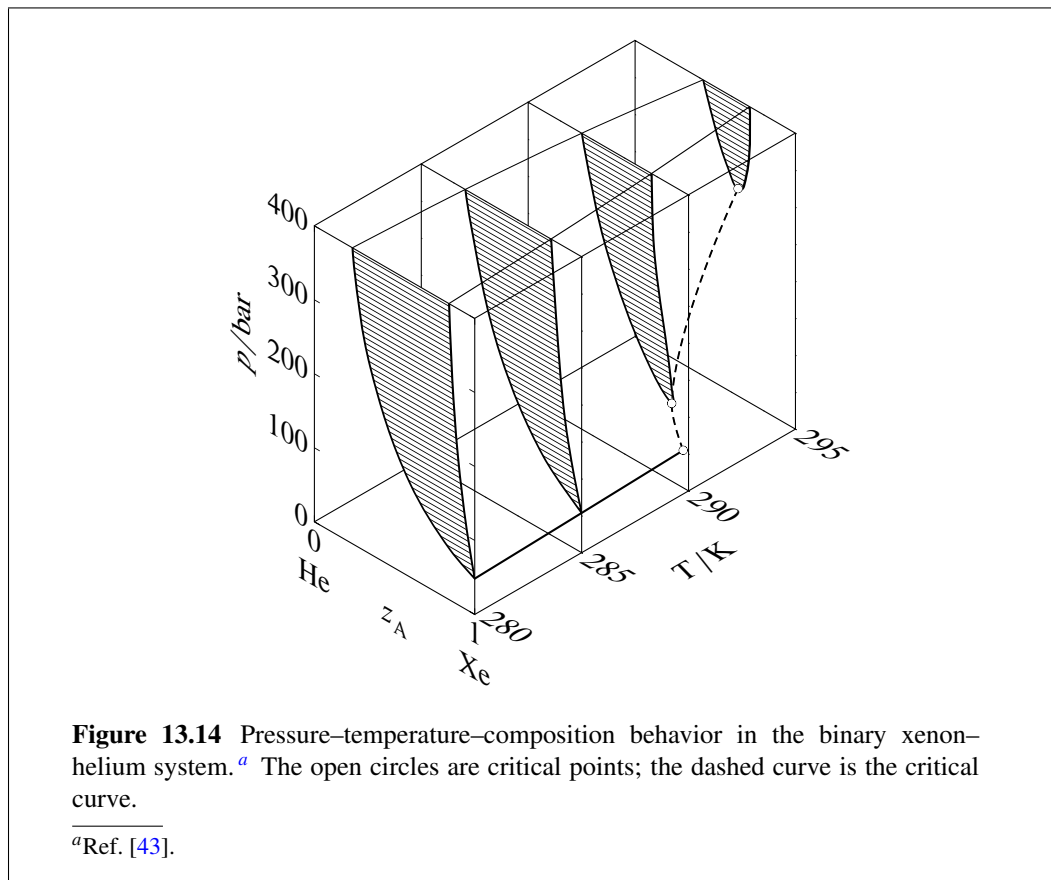

in all proportions as they do at ordinary pressures.

If the pressure of a system is increased isothermally, eventually solid phases will appear; these are not shown in Figs. 13.13 and Fig. 13.14.

13.3 Phase Diagrams: Ternary Systems

A ternary system is one with three components. We can independently vary the temperature, the pressure, and two independent composition variables for the system as a whole. A two-dimensional phase diagram for a ternary system is usually drawn for conditions of constant T and p .

Although we could draw a two-dimensional phase diagram with Cartesian coordinates to express the mole fractions of two of the components, there are advantages in using instead the triangular coordinates shown in Fig. 13.15 on the next page. Each vertex of the equilateral triangle represents one of the pure components A, B, or C. A point on the side of the triangle opposite a vertex represents a binary system of the other two components, and a point within the triangle represents a ternary system with all three components.

To determine the mole fraction z_A of component A in the system as a whole represented by a point within the triangle, we measure the distance to the point from the side of the triangle that is opposite the vertex for pure A, then express this distance as a fraction of the height of the triangle. We follow the same procedure to determine z_B and z_C . The concept

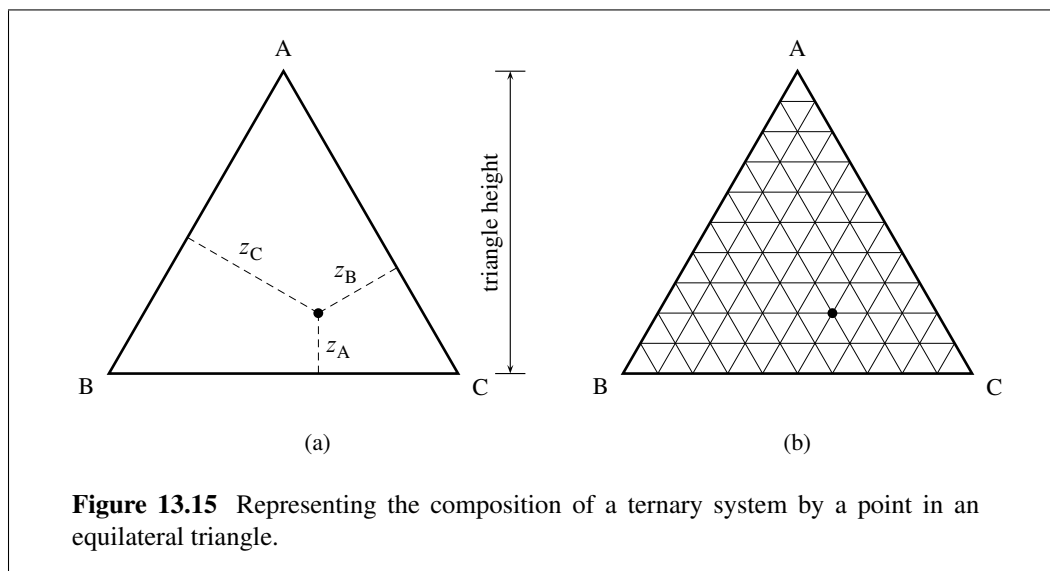

is shown in Fig. 13.15(a).

As an aid for the conversion between the position of a point and the overall composition, we can draw equally-spaced lines within the triangle parallel to the sides as shown in Fig. 13.15(b). One of these lines, being at a constant distance from one side of the triangle, represents a constant mole fraction of one component. In the figure, the lines divide the distance from each side to the opposite vertex into ten equal parts; thus, adjacent parallel lines represent a difference of 0.1 in the mole fraction of a component, starting with 0 at the side of the triangle and ending with 1 at the vertex. Using the lines, we see that the filled circle in the figure represents the overall composition $z_A = 0.20$, $z_B = 0.30$, and $z_C = 0.50$.

The sum of z_A , z_B , and z_C must be 1. The method of representing composition with a point in an equilateral triangle works because the sum of the lines drawn from the point to the three sides, perpendicular to the sides, equals the height of the triangle. The proof is shown in Fig. 13.16 on the next page.

Two useful properties of this way of representing a ternary composition are as follows:

1. Points on a line parallel to a side of the triangle represent systems in which one of the mole fractions remains constant.
2. Points on a line passing through a vertex represent systems in which the ratio of two of the mole fractions remains constant.

13.3.1 Three liquids

Figure 13.17 on page 443 is the ternary phase diagram of a system of ethanol, benzene, and water at a temperature and pressure at which the phases are liquids. When the system point is in the area labeled $P=1$, there is a single liquid phase whose composition is described by the position of the point. The one-phase area extends to the side of the triangle representing binary mixtures of ethanol and benzene, and to the side representing binary mixtures of ethanol and water. In other words, ethanol and benzene mix in all proportions, and so also do ethanol and water.

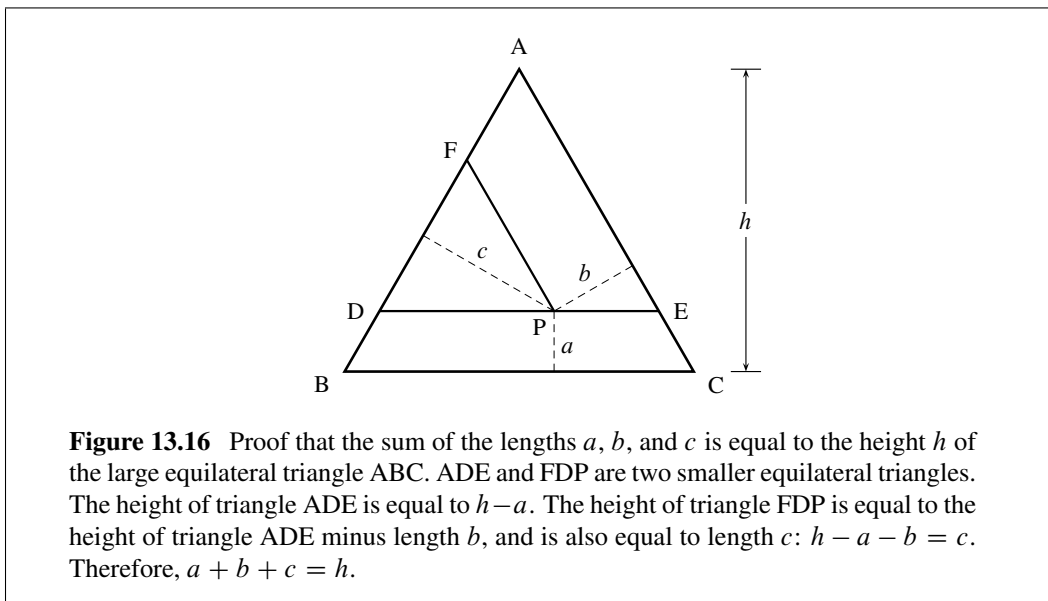

When the overall composition is such that the system point falls in the area labeled $P=2$, two liquid phases are present. The compositions of these phases are given by the positions of the ends of a tie line through the system point. Four representative tie lines are included in the diagram, and these must be determined experimentally. The relative amounts of the two phases can be determined from the lever rule.⁷ In the limit of zero mole fraction of ethanol, the tie line falls along the horizontal base of the triangle and displays a miscibility gap for the binary system of benzene and water. (The conjugate phases are very nearly pure benzene and pure water).

The *plait point* shown as an open circle in the figure is also called a *critical solution point*. As the system point approaches the plait point from within the two-phase area, the length of the tie line through the system point approaches zero, the miscibility gap disappears, and the compositions of the two conjugate liquid phases become identical.

Suppose we have the binary system of benzene and water represented by point a . Two liquid phases are present: one is wet benzene and the other is water containing a very small mole fraction of benzene. If we gradually stir ethanol into this system, the system point moves along the dotted line from point a toward the vertex for pure ethanol, but can never quite reach the vertex. At point b , there are still two phases, and we can consider the ethanol to have distributed itself between two partially-miscible solvents, benzene and water (Sec. 12.6.3). From the position of point b relative to the ends of the tie line passing through point b , we see that the mole fraction of ethanol is greater in the water-rich phase. As we continue to add ethanol, the amount of the water-rich phase increases and the amount of the benzene-rich phase decreases, until at point c the benzene-rich phase completely disappears. The added ethanol has increased the mutual solubilities of benzene and water and resulted in a single liquid phase.

⁷The lever rule works, according to the general derivation in Sec. 8.2.4, because the ratio n_A/n , which is equal to z_A , varies linearly with the position of the system point along a tie line on the triangular phase diagram.

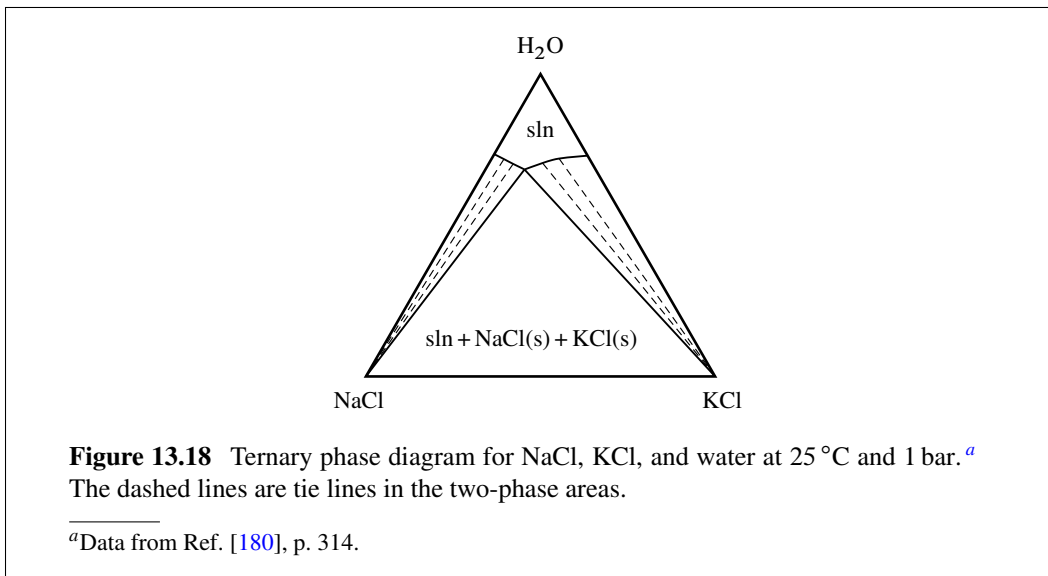
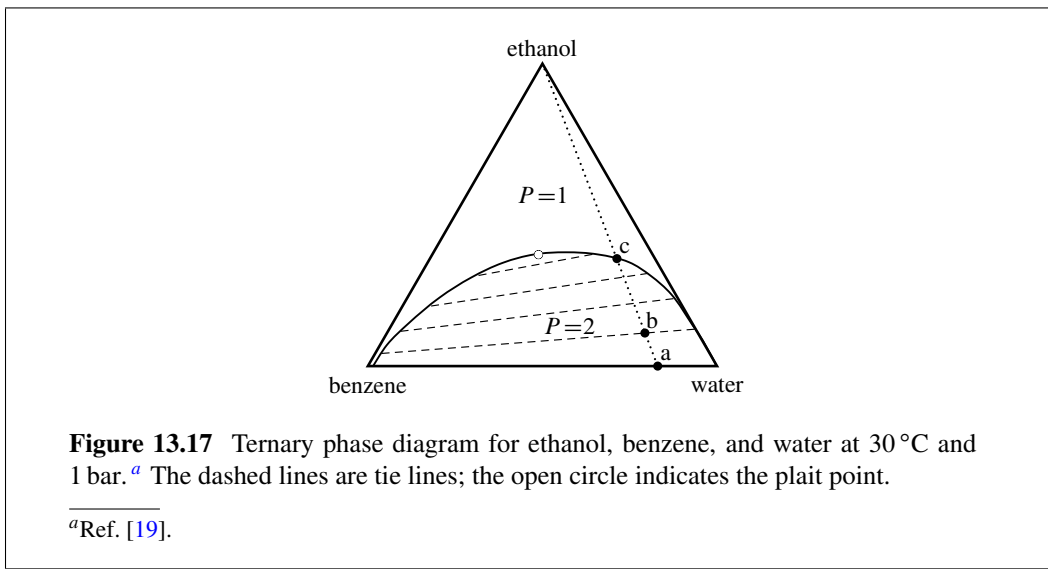

13.3.2 Two solids and a solvent

The phase diagram in Fig. 13.18 is for a ternary system of water and two salts with an ion in common. There is a one-phase area for solution, labeled sln; a pair of two-phase areas in which the phases are a single solid salt and the saturated solution; and a triangular three-phase area. The upper vertex of the three-phase area, the *eutonic point*, represents the composition of solution saturated with respect to both salts. Some representative tie lines are drawn in the two-phase areas.

A system of three components and three phases has two degrees of freedom; at fixed values of T and p , each phase must have a fixed composition. The fixed compositions of the phases that are present when the system point falls in the three-phase area are the compositions at the three vertices of the inner triangle: solid NaCl, solid KCl, and solution of the eutonic composition $x_{\text{NaCl}} = 0.20$ and $x_{\text{KCl}} = 0.11$.

From the position of the curved boundary that separates the one-phase solution area from the two-phase area for solution and solid KCl, we can see that adding NaCl to the saturated solution of KCl decreases the mole fraction of KCl in the saturated solution. Although it is not obvious in the phase diagram, adding KCl to a saturated solution of NaCl decreases the mole fraction of NaCl. These decreases in solubility when a common ion is added are examples of the *common ion effect* mentioned in Sec. 12.5.5.

PROBLEMS

An underlined problem number or problem-part letter indicates that the numerical answer appears in Appendix I.

- 13.1** Consider a single-phase system that is a gaseous mixture of N_2 , H_2 , and NH_3 . For each of the following cases, find the number of degrees of freedom and give an example of the independent intensive variables that could be used to specify the equilibrium state, apart from the total amount of gas.
- There is no reaction.
 - The reaction $\text{N}_2(\text{g}) + 3 \text{H}_2(\text{g}) \rightarrow 2 \text{NH}_3(\text{g})$ is at equilibrium.
 - The reaction is at equilibrium and the system is prepared from NH_3 only.
- 13.2** How many components has a mixture of water and deuterium oxide in which the equilibrium $\text{H}_2\text{O} + \text{D}_2\text{O} \rightleftharpoons 2 \text{HDO}$ exists?
- 13.3** Consider a system containing only $\text{NH}_4\text{Cl}(\text{s})$, $\text{NH}_3(\text{g})$, and $\text{HCl}(\text{g})$. Assume that the equilibrium $\text{NH}_4\text{Cl}(\text{s}) \rightleftharpoons \text{NH}_3(\text{g}) + \text{HCl}(\text{g})$ exists.
- Suppose you prepare the system by placing solid NH_4Cl in an evacuated flask and heating to 400 K. Use the phase rule to decide whether you can vary the pressure while both phases remain in equilibrium at 400 K.
 - According to the phase rule, if the system is not prepared as described in part (a) could you vary the pressure while both phases remain in equilibrium at 400 K? Explain.
 - Rationalize your conclusions for these two cases on the basis of the thermodynamic equilibrium constant. Assume that the gas phase is an ideal gas mixture and use the approximate expression $K = p_{\text{NH}_3} p_{\text{HCl}} / (p^\circ)^2$.
- 13.4** Consider the lime-kiln process $\text{CaCO}_3(\text{s}) \rightarrow \text{CaO}(\text{s}) + \text{CO}_2(\text{g})$. Find the number of intensive variables that can be varied independently in the equilibrium system under the following conditions:
- The system is prepared by placing calcium carbonate, calcium oxide, and carbon dioxide in a container.
 - The system is prepared from calcium carbonate only.
 - The temperature is fixed at 1000 K.
- 13.5** What are the values of C and F in systems consisting of solid AgCl in equilibrium with an aqueous phase containing H_2O , $\text{Ag}^+(\text{aq})$, $\text{Cl}^-(\text{aq})$, $\text{Na}^+(\text{aq})$, and $\text{NO}_3^-(\text{aq})$ prepared in the following ways? Give examples of intensive variables that could be varied independently.
- The system is prepared by equilibrating excess solid AgCl with an aqueous solution of NaNO_3 .
 - The system is prepared by mixing aqueous solutions of AgNO_3 and NaCl in arbitrary proportions; some solid AgCl forms by precipitation.
- 13.6** How many degrees of freedom has a system consisting of solid NaCl in equilibrium with an aqueous phase containing H_2O , $\text{Na}^+(\text{aq})$, $\text{Cl}^-(\text{aq})$, $\text{H}^+(\text{aq})$, and $\text{OH}^-(\text{aq})$? Would it be possible to independently vary T , p , and m_{OH^-} ? If so, explain how you could do this.
- 13.7** Consult the phase diagram shown in Fig. 13.4 on page 430. Suppose the system contains 36.0 g (2.00 mol) H_2O and 58.4 g (1.00 mol) NaCl at 25 °C and 1 bar.
- Describe the phases present in the equilibrium system and their masses.

- (b) Describe the changes that occur at constant pressure if the system is placed in thermal contact with a heat reservoir at -30°C .
- (c) Describe the changes that occur if the temperature is raised from 25°C to 120°C at constant pressure.
- (d) Describe the system after 200 g H_2O is added at 25°C .

Table 13.1 Aqueous solubilities of sodium sulfate decahydrate and anhydrous sodium sulfate^a

$\text{Na}_2\text{SO}_4 \cdot 10\text{H}_2\text{O}$		Na_2SO_4	
$t/^\circ\text{C}$	x_{B}	$t/^\circ\text{C}$	x_{B}
10	0.011	40	0.058
15	0.016	50	0.056
20	0.024		
25	0.034		
30	0.048		

^aRef. [59], p. 179–180.

13.8 Use the following information to draw a temperature–composition phase diagram for the binary system of H_2O (A) and Na_2SO_4 (B) at $p = 1$ bar, confining t to the range -20 to 50°C and z_{B} to the range 0 – 0.2 . The solid decahydrate, $\text{Na}_2\text{SO}_4 \cdot 10\text{H}_2\text{O}$, is stable below 32.4°C . The anhydrous salt, Na_2SO_4 , is stable above this temperature. There is a peritectic point for these two solids and the solution at $x_{\text{B}} = 0.059$ and $t = 32.4^\circ\text{C}$. There is a eutectic point for ice, $\text{Na}_2\text{SO}_4 \cdot 10\text{H}_2\text{O}$, and the solution at $x_{\text{B}} = 0.006$ and $t = -1.3^\circ\text{C}$. Table 13.1 gives the temperature dependence of the solubilities of the ionic solids.

Table 13.2 Data for Problem 13.9. Temperatures of saturated solutions of aqueous iron(III) chloride at $p = 1$ bar (A = FeCl_3 , B = H_2O)^a

x_{A}	$t/^\circ\text{C}$	x_{A}	$t/^\circ\text{C}$	x_{A}	$t/^\circ\text{C}$
0.000	0.0	0.119	35.0	0.286	56.0
0.020	-10.0	0.143	37.0	0.289	55.0
0.032	-20.5	0.157	36.0	0.293	60.0
0.037	-27.5	0.173	33.0	0.301	69.0
0.045	-40.0	0.183	30.0	0.318	72.5
0.052	-55.0	0.195	27.4	0.333	73.5
0.053	-41.0	0.213	32.0	0.343	72.5
0.056	-27.0	0.222	32.5	0.358	70.0
0.076	0.0	0.232	30.0	0.369	66.0
0.083	10.0	0.238	35.0	0.369	80.0
0.093	20.0	0.259	50.0	0.373	100.0
0.106	30.0	0.277	55.0		

^aData from Ref. [59], page 193.

13.9 Iron(III) chloride forms various solid hydrates, all of which melt congruently. Table 13.2 on the preceding page lists the temperatures t of aqueous solutions of various compositions that are saturated with respect to a solid phase.

- Use these data to construct a t - z_B phase diagram for the binary system of FeCl_3 (A) and H_2O (B). Identify the formula and melting point of each hydrate. Hint: derive a formula for the mole ratio n_B/n_A as a function of x_A in a binary mixture.
- For the following conditions, determine the phase or phases present at equilibrium and the composition of each.
 - $t = -70.0^\circ\text{C}$ and $z_A = 0.100$
 - $t = 50.0^\circ\text{C}$ and $z_A = 0.275$

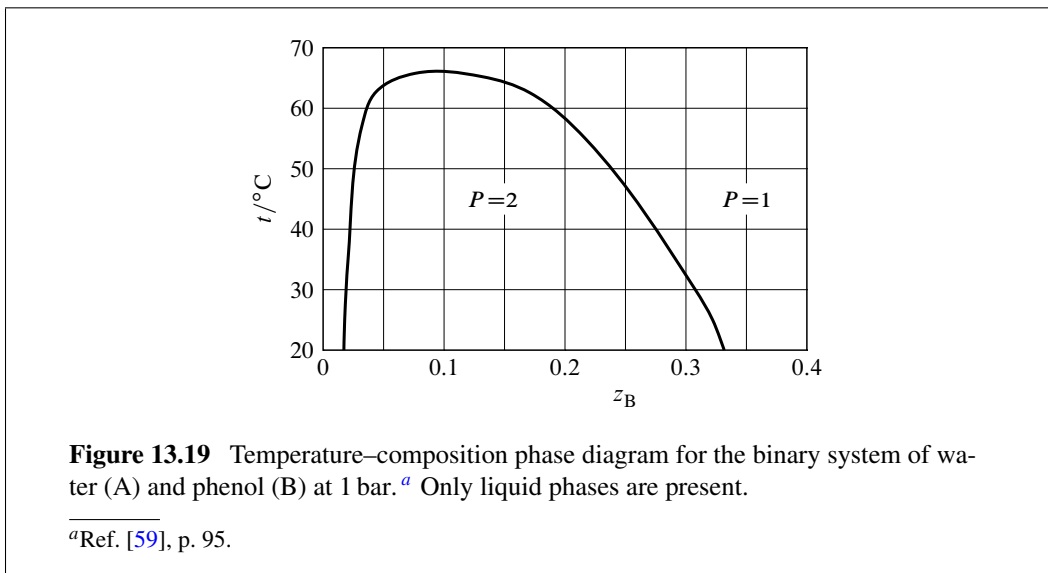

13.10 Figure 13.19 is a temperature–composition phase diagram for the binary system of water (A) and phenol (B) at 1 bar. These liquids are partially miscible below 67°C . Phenol is more dense than water, so the layer with the higher mole fraction of phenol is the bottom layer. Suppose you place 4.0 mol of H_2O and 1.0 mol of phenol in a beaker at 30°C and gently stir to allow the layers to equilibrate.

- What are the compositions of the equilibrated top and bottom layers?
- Find the amount of each component in the bottom layer.
- As you gradually stir more phenol into the beaker, maintaining the temperature at 30°C , what changes occur in the volumes and compositions of the two layers? Assuming that one layer eventually disappears, what additional amount of phenol is needed to cause this to happen?

13.11 The standard boiling point of propane is -41.8°C and that of n -butane is -0.2°C . Table 13.3 on the next page lists vapor pressure data for the pure liquids. Assume that the liquid mixtures obey Raoult's law.

- Calculate the compositions, x_A , of the liquid mixtures with boiling points of -10.0°C , -20.0°C , and -30.0°C at a pressure of 1 bar.
- Calculate the compositions, y_A , of the equilibrium vapor at these three temperatures.

Table 13.3 Saturation vapor pressures of propane (A) and *n*-butane (B)

$t/^\circ\text{C}$	p_A^*/bar	p_B^*/bar
-10.0	3.360	0.678
-20.0	2.380	0.441
-30.0	1.633	0.275

- (c) Plot the temperature–composition phase diagram at $p = 1$ bar using these data, and label the areas appropriately.
- (d) Suppose a system containing 10.0 mol propane and 10.0 mol *n*-butane is brought to a pressure of 1 bar and a temperature of -25°C . From your phase diagram, estimate the compositions and amounts of both phases.

Table 13.4 Liquid and gas compositions in the two-phase system of 2-propanol (A) and benzene at 45°C ^a

x_A	y_A	p/kPa	x_A	y_A	p/kPa
0	0	29.89	0.5504	0.3692	35.32
0.0472	0.1467	33.66	0.6198	0.3951	34.58
0.0980	0.2066	35.21	0.7096	0.4378	33.02
0.2047	0.2663	36.27	0.8073	0.5107	30.28
0.2960	0.2953	36.45	0.9120	0.6658	25.24
0.3862	0.3211	36.29	0.9655	0.8252	21.30
0.4753	0.3463	35.93	1.0000	1.0000	18.14

^aRef. [24].

- 13.12** Use the data in Table 13.4 to draw a pressure–composition phase diagram for the 2-propanol–benzene system at 45°C . Label the axes and each area.

Table 13.5 Liquid and gas compositions in the two-phase system of acetone (A) and chloroform at 35.2°C ^a

x_A	y_A	p/kPa	x_A	y_A	p/kPa
0	0	39.08	0.634	0.727	36.29
0.083	0.046	37.34	0.703	0.806	38.09
0.200	0.143	34.92	0.815	0.896	40.97
0.337	0.317	33.22	0.877	0.936	42.62
0.413	0.437	33.12	0.941	0.972	44.32
0.486	0.534	33.70	1.000	1.000	45.93
0.577	0.662	35.09			

^aRef. [179], p. 286.

- 13.13** Use the data in Table 13.5 to draw a pressure–composition phase diagram for the acetone–chloroform system at 35.2°C . Label the axes and each area.

GALVANIC CELLS

An *electrochemical cell* is a system in which passage of an electric current through an electrical circuit is linked to an internal cell reaction. A **galvanic cell**, or voltaic cell, is an electrochemical cell that, when isolated, has an electric potential difference between its terminals; the cell is said to be a *seat of electromotive force*.

The cell reaction in a galvanic cell differs in a fundamental way from the same reaction (i.e., one with the same reaction equation) taking place in a reaction vessel that is not part of an electrical circuit. In the reaction vessel, the reactants and products are in the same phase or in phases in contact with one another, and the reaction advances in the spontaneous direction until reaction equilibrium is reached. This reaction is the *direct reaction*.

The galvanic cell, in contrast, is arranged with the reactants physically separated from one another so that the cell reaction can advance only when an electric current passes through the cell. If there is no current, the cell reaction is constrained from taking place. When the electrical circuit is open and the cell is isolated from its surroundings, a state of thermal, mechanical, and transfer equilibrium is rapidly reached. In this state of *cell equilibrium* or *electrochemical equilibrium*, however, reaction equilibrium is not necessarily present—that is, if the reactants and products were moved to a reaction vessel at the same activities, there might be spontaneous advancement of the reaction.

As will be shown, measurements of the cell potential of a galvanic cell are capable of yielding precise values of molar reaction quantities of the cell reaction and thermodynamic equilibrium constants, and of mean ionic activity coefficients in electrolyte solutions.

14.1 Cell Diagrams and Cell Reactions

14.1.1 Elements of a galvanic cell

We will treat a galvanic cell as a *system*. The cell has two metal wires called *terminals* that pass through the system boundary. Within the cell are phases that can conduct an electric current and are collectively called *electrical conductors*. Each terminal is attached to an *electron conductor* that is usually a metal, but might also be graphite or a semiconductor. Each electron conductor is in contact with an *ionic conductor*, usually an electrolyte solution, through which ions but not electrons can move. Both of the electron conductors can be in contact with the same ionic conductor; or they can be in contact with separate ionic conductors, in which case the ionic conductors contact one another at a *liquid junction*. The

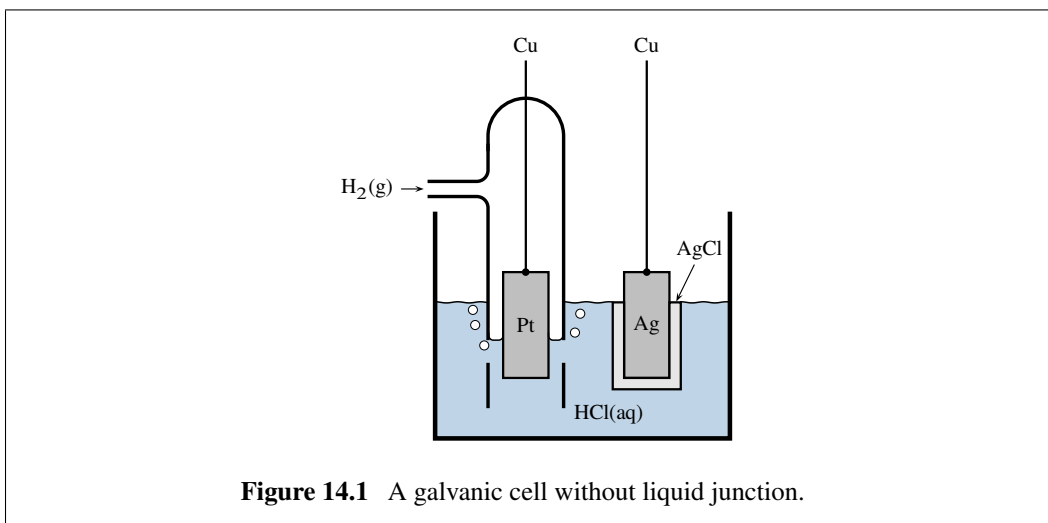

Figure 14.1 A galvanic cell without liquid junction.

general arrangement of the physical elements of a galvanic cell is therefore

terminal – electron conductor – ionic conductor(s) – electron conductor – terminal

Both terminals must be the same metal (usually copper) in order for it to be possible to measure the electric potential difference between them.

The combination of an electron conductor and the ionic conductor in contact with it is called an **electrode**,¹ or half-cell. To describe a galvanic cell, it is conventional to distinguish the *left* and *right* electrodes. In this way, we establish a left–right association with the reactants and products of the reactions at the electrodes.

14.1.2 Cell diagrams

Consider the galvanic cell depicted in Fig. 14.1. This cell has a hydrogen electrode at the left and a silver–silver chloride electrode at the right. The hydrogen electrode is a strip of platinum in contact with hydrogen gas and with aqueous hydrochloric acid, which is the ionic conductor. In the type of hydrogen electrode shown in the figure, hydrogen gas is introduced through a side tube into a closed-end glass jacket that surrounds the platinum strip and is immersed in the hydrochloric acid; the gas bubbles out through holes near the bottom of the tube. The silver–silver chloride electrode is a silver strip or wire that dips into the hydrochloric acid and is coated with solid silver chloride.

The cell in Fig. 14.1 is compactly described by the following *cell diagram*:



A cell diagram indicates which electrode is at the left and which is at the right, and shows the reactants and products of the two electrode reactions. A single vertical bar represents a phase boundary. Commas are used to separate different species in the same phase.

The same cell can be described by a slightly different cell diagram that omits the copper terminals seen in the figure and shows the electrolyte solute instead of the ion species:

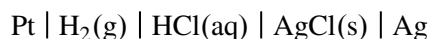

¹The term “electrode” is sometimes used to refer to just the electron conductor.

The reason it is not necessary to include the terminals is that the property whose value we seek, the zero-current cell potential, is the same regardless of the metal used for the terminals.

14.1.3 Electrode reactions and the cell reaction

A cell diagram, with its designation of the left and right electrodes, allows us to write reaction equations for the cell. These equations are written according to the convention that electrons enter at the right terminal and leave at the left terminal.

At each electrode there is an **electrode reaction**, or half-reaction, one for reduction at the right electrode and the other for oxidation at the left electrode. The reaction equations for the electrode reactions include electrons as either a reactant (at the right terminal) or a product (at the left terminal). The **cell reaction** describes the overall chemical change; its reaction equation is the sum of the equations for the two electrode reactants with cancellation of the electrons.

For instance, we can write the electrode reactions of the cell of Fig. 14.1 as follows.

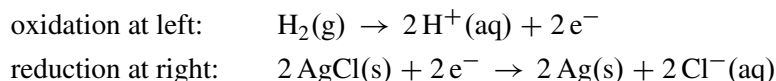

As written here, the stoichiometric numbers of the electrons have the same absolute value (2) in both reaction equations. This allows the electrons to cancel when we add the electrode reactions to form the cell reaction:

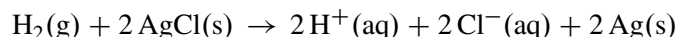

The cell of Fig. 14.1 has a single electrolyte phase with essentially the same composition at both electrodes, and is an example of a *cell without liquid junction* or *cell without transference*. As an example of a *cell with transference*, consider the cell diagram

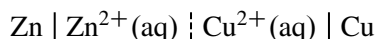

This is the zinc–copper cell depicted in Fig. 14.2 on the next page, sometimes called a Daniell cell. The two electrolyte phases are separated by a liquid junction represented in the cell diagram by the dashed vertical bar. If the liquid junction potential can be assumed to be negligible, the liquid junction is instead represented by a pair of dashed vertical bars:

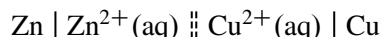

14.1.4 Advancement and charge

The **electron number** or charge number, z , of the cell reaction is defined as the amount of electrons entering at the right terminal per unit advancement of the cell reaction. z is a positive dimensionless quantity equal to $|\nu_e|$, where ν_e is the stoichiometric number of the electrons in either of the electrode reactions whose sum is the cell reaction.

Because both electrode reactions are written with the same value of $|\nu_e|$, the advancements of these reactions and of the cell reaction are all described by the same advancement variable ξ . For an infinitesimal change $d\xi$, an amount of electrons equal to $z d\xi$ enters the

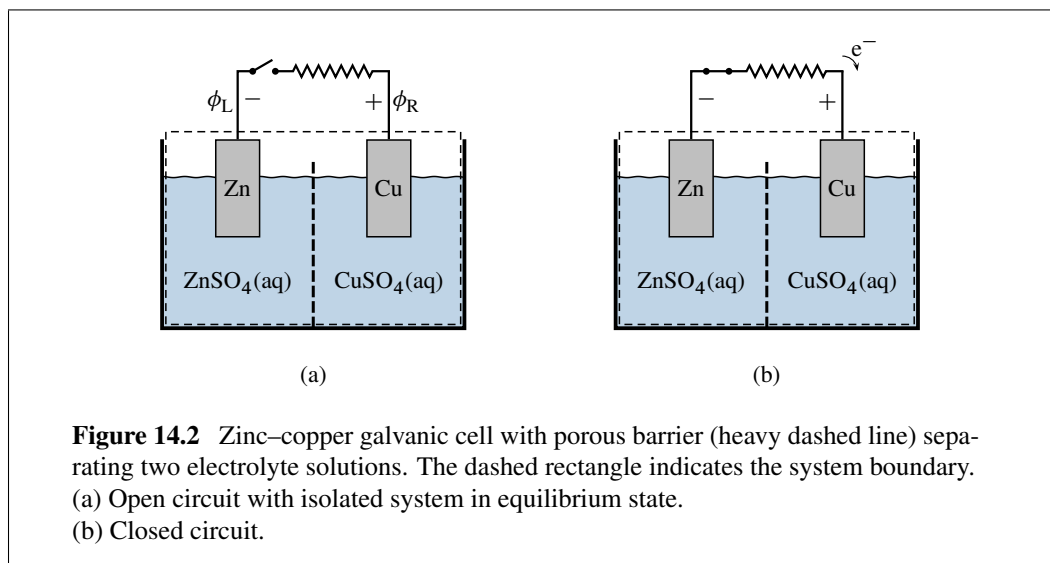

Figure 14.2 Zinc–copper galvanic cell with porous barrier (heavy dashed line) separating two electrolyte solutions. The dashed rectangle indicates the system boundary.
 (a) Open circuit with isolated system in equilibrium state.
 (b) Closed circuit.

system at the right terminal, an equal amount of electrons leaves at the left terminal, and there is no buildup of charge in any of the internal phases.

The **Faraday constant** F is a physical constant defined as the charge per amount of protons, and is equal to the product of the elementary charge (the charge of a proton) and the Avogadro constant: $F = eN_A$. Its value to five significant figures is $F = 96,485 \text{ C mol}^{-1}$. The charge per amount of electrons is $-F$. Thus, the charge entering the right terminal during advancement $d\xi$ is

$$dQ_{\text{sys}} = -zF d\xi \quad (14.1.1)$$

14.2 Electric Potentials in the Cell

As explained at the beginning of Sec. 3.8, the **electric potential** ϕ at a point in space is defined as the change in the electrical potential energy of an infinitesimal test charge when it is brought to this point from a position infinitely far from other charges, divided by the charge.

We are concerned with the electric potential within a phase—the inner electric potential, or *Galvani potential*. We can measure the difference between the values of this electric potential in the two terminals of a galvanic cell, provided the terminals have the same chemical composition. If the terminals were of different metals, at least one of them would have an unknown metal–metal contact potential in its connection to the external measuring circuit.

Since we will be applying the concept of electric potential to macroscopic phases, the value of the Galvani potential at a point in a phase should be interpreted as the *average* value in a small volume element at this point that is large enough to contain many molecules.

14.2.1 Cell potential

The **cell potential** of a galvanic cell is the electric potential difference between terminals of the same metal, and is defined by Eq. 3.8.6:

$$E_{\text{cell}} \stackrel{\text{def}}{=} \phi_{\text{R}} - \phi_{\text{L}} \quad (14.2.1)$$

The subscripts R and L refer to the right and left terminals. The **equilibrium cell potential**, $E_{\text{cell, eq}}$, is the cell potential measured under conditions of zero current when the cell is assumed to be in an equilibrium state.²

Over a relatively long period of time, the state of an isolated galvanic cell is found to change. Nevertheless, the assumption of an equilibrium state is valid if the changes are very slow compared to the period during which we measure E_{cell} .

The long-term changes can be of two types. If there is a liquid junction between electrolyte solutions of different composition, slow diffusion of ions through the junction is inevitable.

In a cell without a liquid junction, the reactants of the cell reaction can react directly without the passage of an electric current. For instance, in the cell of Fig. 14.1 the electrolyte solution is saturated with respect to gaseous H_2 and solid AgCl , and therefore contains very small concentrations of dissolved H_2 molecules and Ag^+ ions. The direct reaction $\text{H}_2 + 2 \text{Ag}^+ \rightarrow 2 \text{H}^+ + 2 \text{Ag}$ occurs irreversibly and continuously in the solution, but is slow on account of the low concentrations.

It is entirely arbitrary whether we show a particular electrode at the left or the right of the cell diagram, although often there is a preference to place the electrode attached to the positive terminal at the right. If we exchange the positions of the two electrodes in the diagram, then we must reverse the reaction equations for the electrode reactions and the cell reaction.

For example, it is found that the zinc–copper cell of Fig. 14.2, with typical electrolyte molalities, has its positive terminal at the copper electrode. When we write the cell diagram as

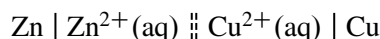

then E_{cell} and $E_{\text{cell, eq}}$ are positive. If we connect the two terminals by an external resistor as depicted in Fig. 14.2(b), electrons will flow from the left terminal through the external resistor and wires to the right terminal, and the cell reaction

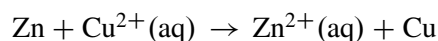

will occur spontaneously in the forward direction.

If, however, we draw the cell diagram the other way around:

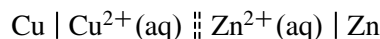

then the positive terminal is at the left, E_{cell} and $E_{\text{cell, eq}}$ are negative, and electrons will flow through an external resistor from the right terminal to the left terminal. Since the cell reaction should show reduction at the right electrode and oxidation at the left, we must now write it as

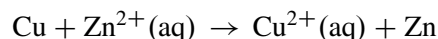

even though the arrow is not in the direction of the reaction that actually occurs spontaneously. In other words, the cell reaction is written according to the cell diagram, not according to the direction of the spontaneous change.

²The equilibrium cell potential used to be called the electromotive force, or emf. These names are deprecated by the IUPAC Green Book (Ref. [36], p. 71) because a potential difference is not a force.

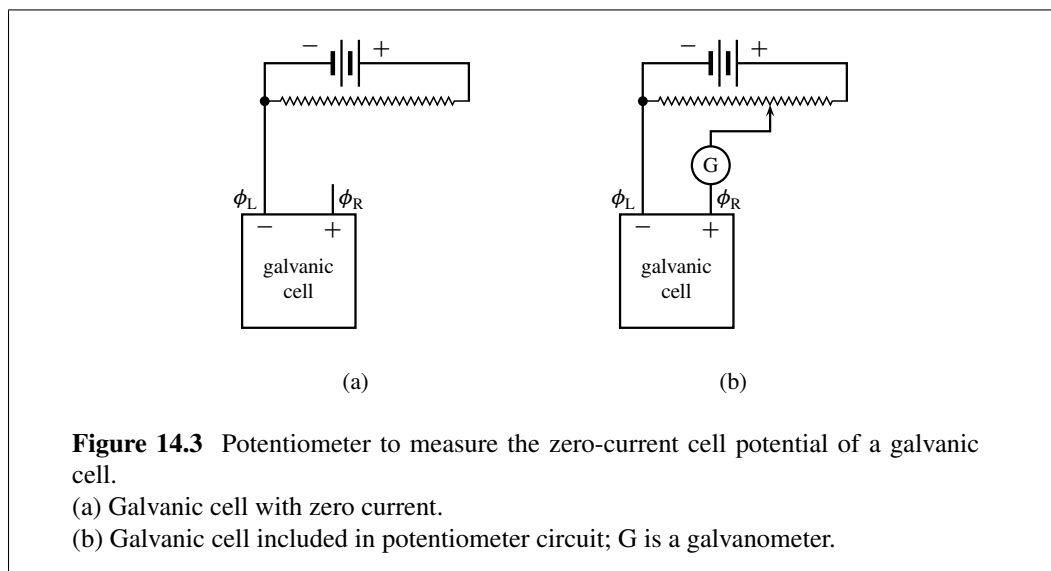

Figure 14.3 Potentiometer to measure the zero-current cell potential of a galvanic cell.
 (a) Galvanic cell with zero current.
 (b) Galvanic cell included in potentiometer circuit; G is a galvanometer.

14.2.2 Measuring the equilibrium cell potential

Figure 14.3 shows how we can use a potentiometer to determine the equilibrium cell potential. Consider Fig. 14.3(a). Outside the galvanic cell is an external circuit with a battery that allows an electric current to pass through a slidewire resistor. The cell's negative terminal is connected to the negative terminal of the battery. Since the cell is not part of this circuit, no current passes through the cell, and $\phi_R - \phi_L$ is the zero-current cell potential $E_{\text{cell,eq}}$. The left end of the slidewire is at the same electric potential as the left terminal of the cell.

In the setup shown in Fig. 14.3(a), the electric potential within the slidewire is a linear function of the distance from the left end. At some position along the slidewire, the electric potential is equal to ϕ_R . We can determine this position by connecting the right terminal of the cell to a slidewire contact as shown in Fig. 14.3(b). When we place the contact at this particular position along the slidewire, there is no electric potential gradient in the connecting wire, and the galvanometer indicates a condition of zero current in the wire. It is a straightforward procedure to evaluate $\phi_R - \phi_L$ from the zero-current position of the contact; this value is still equal to $E_{\text{cell,eq}}$. When we keep the slidewire contact in this position, no current passes through the cell; but if we displace the contact from this position in either direction along the slidewire, current will pass in one direction or the other through the cell.

In practice, it is more convenient to measure the zero-current cell potential with a high-impedance digital voltmeter (a voltmeter that draws negligible current) instead of with a potentiometer circuit.

14.2.3 Interfacial potential differences

What is the source of an open-circuit, zero-current cell potential? When no electric current passes through the cell, the electric potential must be uniform within each bulk phase that is an electrical conductor, because otherwise there would be a spontaneous movement of charged particles (electrons or ions) through the phase. Electric potential differences in a cell without current therefore exist only at phase boundaries. The equilibrium cell poten-

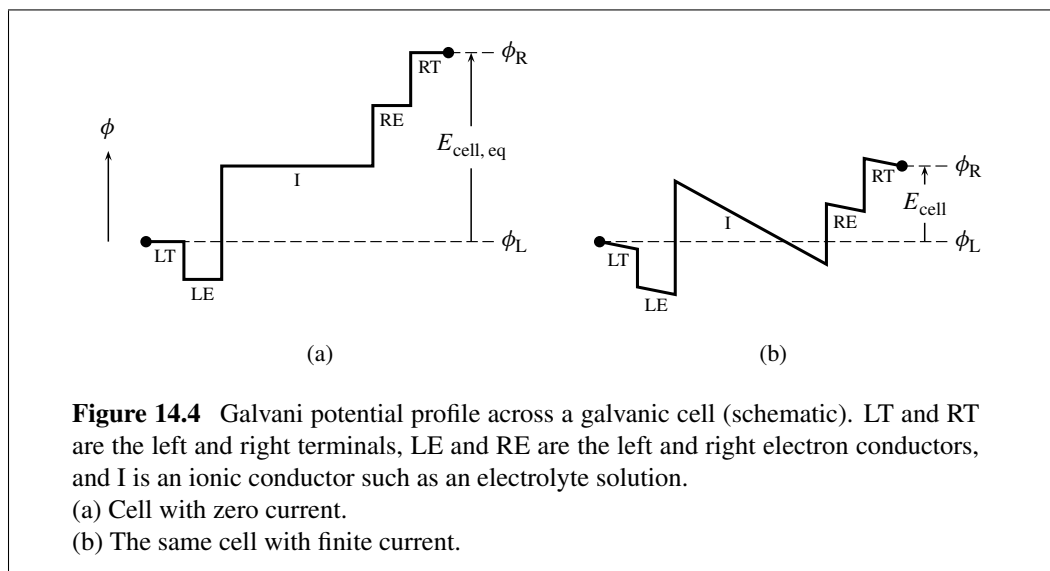

tial is the cumulative result of these potential differences at interfaces between different conducting phases within the cell.

An interfacial potential difference appears as a vertical step in a profile of the Galvani potential, as shown schematically in Fig. 14.4(a). The zero-current cell potential, $E_{\text{cell,eq}}$, is the algebraic sum of the interfacial potential differences within the cell.

When an external resistor is connected to the terminals to form a circuit, current passes through the cell and the cell performs electrical work on the surroundings. Figure 14.4(b) shows what happens to the potential profile in this case: the interfacial potential differences are still present within the cell, and the internal resistance of the electrical conductors causes E_{cell} to be reduced in magnitude compared to $E_{\text{cell,eq}}$.

We shall next look briefly at the origin and consequences of potential differences at interfaces between (1) two different metals, (2) a metal and an electrolyte solution, and (3) two different electrolyte solutions. Keep in mind that these potential differences are theoretical concepts whose values cannot be measured experimentally.

Metal–metal contacts

An electric potential difference at an interface between two metals is called a *contact potential*. When two different metals are placed in contact, the local densities of the free (mobile) electrons change so as to form an electrical double layer with an excess positive charge on one side of the interface and an excess negative charge of equal magnitude on the other side. The electrical double layer creates the contact potential.

To understand why a stable equilibrium state of two metals in contact includes a contact potential, we can consider the chemical potential of the free electrons. The concept of chemical potential (i.e., partial molar Gibbs energy) applies to the free electrons in a metal just as it does to other species. The dependence of the chemical potential μ_e^α of free electrons in metal phase α on the electric potential ϕ^α of the phase is given by the relation of Eq. 10.1.6 on page 288, with the charge number z_i set equal to -1 :

$$\mu_e^\alpha(\phi) = \mu_e^\alpha(0) - F\phi^\alpha \quad (14.2.2)$$

Here $\mu_e^\alpha(0)$ is the electron chemical potential in a phase with the same intensive properties as phase α but at zero electric potential. $\mu_e^\alpha(0)$ depends only on the temperature and the composition of phase α . (The dependence on pressure is so small for a solid that we will ignore it.)

Consider two or more electron conductors that are so arranged that electrons can freely transfer among them. There is the usual condition for transfer equilibrium in these phases: the chemical potential (in this case μ_e) is the same in each phase. Thus, electron transfer equilibrium between phases α and β requires μ_e^α and μ_e^β to be equal. We equate μ_e^α and μ_e^β , substitute from Eq. 14.2.2 to obtain $\mu_e^\alpha(0) - F\phi^\alpha = \mu_e^\beta(0) - F\phi^\beta$, and rearrange to

$$\phi^\beta - \phi^\alpha = \frac{\mu_e^\beta(0) - \mu_e^\alpha(0)}{F} \quad (14.2.3)$$

(phases in electron transfer equilibrium)

The quantities on the right side of Eq. 14.2.3 are functions only of the temperature and the compositions of phases α and β . If the phases have the same temperature and composition and are in electron transfer equilibrium, ϕ^α and ϕ^β are equal.

For an equilibrium state of metals α and β in contact, Eq. 14.2.3 shows that the contact potential $\phi^\beta - \phi^\alpha$ depends only on the temperature and the compositions of the two metals.³

Equation 14.2.3 explains why a galvanic cell must have at least one electrical conductor that is not an electron conductor. If electrons were free to pass from one terminal through the system to the other terminal of the same temperature and composition, then in a zero-current equilibrium state μ_e would be the same in both terminals. In that case there would be no potential difference between the terminals, and the system would not be a galvanic cell.

Metal–electrolyte interfaces

An electrode reaction of a galvanic cell takes place at the interface between a metal electron conductor and an electrolyte solution. In an equilibrium state of the cell, the electrode reaction is at equilibrium. The condition for this equilibrium is $\sum_i \nu_i \mu_i = 0$, where the sum is over the reactants and products of the electrode reaction, including the electrons. The chemical potentials of the ions and electrons in the electrode reaction are functions of the electric potentials of their phases. Consequently, in order for the sum to be zero, the metal and solution must in general have different electric potentials.

For example, consider the zinc–copper cell of Fig. 14.2. The electrode reaction of the copper electrode at the right is

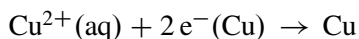

where the metal phase of the electrons is indicated in parentheses. In order for this electrode reaction to be at equilibrium, the interfacial potential difference between the copper conductor and the solution containing Cu^{2+} ions must be such that the following condition is satisfied:

$$\mu(\text{Cu}) - \mu(\text{Cu}^{2+}) - 2\mu_e(\text{Cu}) = 0 \quad (14.2.4)$$

³The temperature dependence of a contact potential between two different metals is the basis of the operation of a thermocouple or thermopile to measure temperature (Sec. 2.3.6).

The interfacial potential difference can arise from a combination of charge separation across the interface, orientation of polar molecules on the solution side of the interface, and specific adsorption of ions. The thickness of the zones in which properties differ from those in the bulk phases is probably no greater than 10^{-11} m on the metal side and 10^{-7} m on the solution side.

Liquid junctions

Some galvanic cells contain two electrolyte solutions with different compositions. These solutions must be separated by a porous barrier or some other kind of junction in order to prevent rapid mixing. At this liquid junction in the zero-current cell, there is in general a *liquid junction potential* caused by diffusion of ions between the two bulk electrolyte phases.

To understand this phenomenon, imagine the situation that would exist at the junction if both solution phases had the same electric potential. An ion species with different chemical potentials in the two solutions would spontaneously diffuse across the junction in the direction of lower chemical potential. Different ions would diffuse at different rates, resulting in a net charge transfer across the junction and an electric potential difference. It is this electric potential difference in the equilibrium state of the cell that prevents further net charge transfer under zero-current conditions.

The liquid junction may consist of a bridging solution in a *salt bridge*. A commonly used kind of salt bridge is a glass tube filled with gel made from agar and concentrated aqueous KCl or KNO_3 ; this type of liquid junction is believed to reduce the liquid junction potential to several millivolts or less.

14.3 Molar Reaction Quantities of the Cell Reaction

This book will denote the molar reaction Gibbs energy of a cell reaction by $\Delta_r G_{\text{cell}}$. This notation distinguishes it from the molar reaction Gibbs energy $\Delta_r G$ of the direct reaction, which may have a different value because in the cell the chemical potential of an ionic species is affected by the electric potential of its phase. $\Delta_r G_{\text{cell}}$ is defined by

$$\Delta_r G_{\text{cell}} \stackrel{\text{def}}{=} \sum_i \nu_i \mu_i \quad (14.3.1)$$

where the sum is over the reactants and products of the cell reaction. $\Delta_r G_{\text{cell}}$ is also equal to the partial derivative $(\partial G_{\text{cell}}/\partial \xi)_{T,p}$, where ξ is the advancement of the cell reaction.

14.3.1 Relation between $\Delta_r G_{\text{cell}}$ and $E_{\text{cell,eq}}$

When a galvanic cell is in a zero-current equilibrium state, both electrode reactions are at reaction equilibrium. In the electrode reaction at the left electrode, electrons are a product with stoichiometric number equal to z . At the right electrode, electrons are a reactant with stoichiometric number equal to $-z$. We can write the conditions for electrode reaction equilibria as follows:

$$\text{At the left electrode} \quad \sum_i \nu_i \mu_i + z\mu_e(\text{LE}) = 0 \quad (14.3.2)$$

$$\text{At the right electrode} \quad \sum_j v_j \mu_j - z \mu_e(\text{RE}) = 0 \quad (14.3.3)$$

In these equations, the sum over i is for the chemical species (excluding electrons) of the electrode reaction at the left electrode, and the sum over j is for the chemical species of the electrode reaction at the right electrode. $\mu_e(\text{LE})$ is the chemical potential of electrons in the electron conductor of the left electrode, and $\mu_e(\text{RE})$ is the chemical potential of electrons in the electron conductor of the right electrode.

Adding Eqs. 14.3.2 and 14.3.3, we obtain

$$\sum_i v_i \mu_i + \sum_j v_j \mu_j + z[\mu_e(\text{LE}) - \mu_e(\text{RE})] = 0 \quad (14.3.4)$$

The first two terms on the left side of Eq. 14.3.4 are sums over all the reactants and products of the cell reaction. From Eq. 14.3.1, we recognize the sum of these terms as the molar reaction Gibbs energy of the cell reaction:

$$\sum_i v_i \mu_i + \sum_j v_j \mu_j = \Delta_r G_{\text{cell}} \quad (14.3.5)$$

Substituting from Eq. 14.3.5 into Eq. 14.3.4 and solving for $\Delta_r G_{\text{cell}}$, we obtain

$$\Delta_r G_{\text{cell}} = -z[\mu_e(\text{LE}) - \mu_e(\text{RE})] \quad (14.3.6)$$

In a zero-current equilibrium state, there is electron transfer equilibrium between the left electron conductor and the left terminal, and between the right electron conductor and the right terminal: $\mu_e(\text{LE}) = \mu_e(\text{LT})$ and $\mu_e(\text{RE}) = \mu_e(\text{RT})$, where $\mu_e(\text{LT})$ and $\mu_e(\text{RT})$ are the chemical potentials of electrons in the left terminal and right terminal, respectively. Thus we can rewrite Eq. 14.3.6 as

$$\Delta_r G_{\text{cell}} = -z[\mu_e(\text{LT}) - \mu_e(\text{RT})] \quad (14.3.7)$$

Making substitutions from Eq. 14.2.2 for $\mu_e(\text{LT})$ and $\mu_e(\text{RT})$, and recognizing that $\mu_e(0)$ is the same in both terminals because they have the same composition, we obtain

$$\begin{aligned} \Delta_r G_{\text{cell}} &= -zF(\phi_R - \phi_L) \\ &= -zFE_{\text{cell, eq}} \end{aligned} \quad (14.3.8)$$

We can see from Eq. 14.3.1 that the value of $\Delta_r G_{\text{cell}}$ has nothing to do with the composition of the terminals. The relations of Eq. 14.3.8 were derived for a cell with both terminals made of the same metal. We can make the following deductions for such a cell:

1. Neither the potential difference $\phi_R - \phi_L$ nor the equilibrium cell potential $E_{\text{cell, eq}}$ depend on the kind of metal used for the terminals.
2. If we interpose a metal conductor of any composition between the electron conductor and the terminal of one of the electrodes, μ_e will have the same value in all three conductors and there will be no effect on the value of $E_{\text{cell, eq}}$.

Equation 14.3.8 can be derived by a different route. According to Eq. 5.8.6 on page 149, reversible electrical work at constant T and p is equal to the Gibbs energy change: $\delta w_{\text{el, rev}} = dG_{\text{cell}}$. Making the substitution $\delta w_{\text{el, rev}} = E_{\text{cell, eq}} \delta Q_{\text{sys}}$ (from Eq. 3.8.8),

with dQ_{sys} set equal to $-zF d\xi$ (Eq. 14.1.1), followed by division by $d\xi$, gives $-zFE_{\text{cell,eq}} = (\partial G_{\text{cell}}/\partial \xi)_{T,p}$, or $\Delta_r G_{\text{cell}} = -zFE_{\text{cell,eq}}$.

Strictly speaking, this derivation applies only to a cell without a liquid junction. In a cell with a liquid junction, the electric current is carried across the junction by different ions depending on the direction of the current, and the cell is therefore not reversible.

14.3.2 Relation between $\Delta_r G_{\text{cell}}$ and $\Delta_r G$

Suppose we have a galvanic cell in a particular zero-current equilibrium state. Each phase of the cell has the same temperature and pressure and a well-defined chemical composition. The activity of each reactant and product of the cell reaction therefore has a definite value in this state.

Now imagine a reaction vessel that has the same temperature and pressure as the galvanic cell, and contains the same reactants and products at the same activities as in the cell. This reaction vessel, unlike the cell, is not part of an electrical circuit. In it, the reactants and products are in direct contact with one another, so there is no constraint preventing a spontaneous direct reaction. For example, the reaction vessel corresponding to the zinc-copper cell of Fig. 14.2 would have zinc and copper strips in contact with a solution of both ZnSO_4 and CuSO_4 . Another example is the slow direct reaction in a cell without liquid junction described on page 453.

Let the reaction equation of the direct reaction be written with the same stoichiometric numbers ν_i as in the reaction equation for the cell reaction. The direct reaction in the reaction vessel is described by this equation or its reverse, depending on which direction is spontaneous for the given activities.

The question now arises whether the molar reaction Gibbs energy $\Delta_r G_{\text{cell}}$ of the cell reaction is equal to the molar reaction Gibbs energy $\Delta_r G$ of the direct reaction. Both $\Delta_r G_{\text{cell}}$ and $\Delta_r G$ are defined by the sum $\sum_i \nu_i \mu_i$. Both reactions have the same values of ν_i , but the values of μ_i for charged species are in general different in the two systems because the electric potentials are different.

Consider first a cell without a liquid junction. This kind of cell has a single electrolyte solution, and all of the reactant and product ions of the cell reaction are in this solution phase. The same solution phase is present in the reaction vessel during the direct reaction. When all ions are in the same phase, the value of $\sum_i \nu_i \mu_i$ is independent of the electric potentials of any of the phases (see the comment following Eq. 11.8.4 on page 351), so that the molar reaction Gibbs energies are the same for the cell reaction and the direct reaction:

$$\Delta_r G_{\text{cell}} = \Delta_r G \quad (14.3.9)$$

(no liquid junction)

Next, consider a cell with two electrolyte solutions separated by a liquid junction. For the molar reaction Gibbs energy of the cell reaction, we write

$$\Delta_r G_{\text{cell}} = \sum_i \nu_i \mu_i(\phi_i) + \sum_j \nu_j \mu_j(\phi_j) \quad (14.3.10)$$

The sums here include all of the reactants and products appearing in the cell reaction, those with index i being at the left electrode and those with index j at the right electrode. Let the

solution at the left electrode be phase α and the solution at the right electrode be phase β . Then making the substitution $\mu_i(\phi) = \mu_i(0) + z_i F \phi$ (Eq. 10.1.6) gives us

$$\Delta_r G_{\text{cell}} = \sum_i v_i \mu_i(0) + \sum_j v_j \mu_j(0) + \sum_i v_i z_i F \phi^\alpha + \sum_j v_j z_j F \phi^\beta \quad (14.3.11)$$

The sum of the first two terms on the right side of Eq. 14.3.11 is the molar reaction Gibbs energy of a reaction in which the reactants and products are in phases of zero electric potential. According to the comment following Eq. 11.8.4, the molar reaction Gibbs energy would be the same if the ions were in a single phase of any electric potential. Consequently the sum $\sum_i v_i \mu_i(0) + \sum_j v_j \mu_j(0)$ is equal to $\Delta_r G$ for the direct reaction.

The conservation of charge during advancement of the electrode reactions at the left electrode and the right electrode is expressed by $\sum_i v_i z_i - z = 0$ and $\sum_j v_j z_j + z = 0$, respectively. Equation 14.3.11 becomes

$$\Delta_r G_{\text{cell}} = \Delta_r G - z F E_j \quad (14.3.12)$$

(cell with liquid junction)

where $E_j = \phi^\beta - \phi^\alpha$ is the liquid junction potential.

Finally, in Eqs. 14.3.9 and 14.3.12 we replace $\Delta_r G_{\text{cell}}$ by $-z F E_{\text{cell,eq}}$ (Eq. 14.3.8) and solve for $E_{\text{cell,eq}}$:

$$E_{\text{cell,eq}} = -\frac{\Delta_r G}{z F} \quad (14.3.13)$$

(cell without liquid junction)

$$E_{\text{cell,eq}} = -\frac{\Delta_r G}{z F} + E_j \quad (14.3.14)$$

(cell with liquid junction)

$E_{\text{cell,eq}}$ can be measured with great precision. If a reaction can be carried out in a galvanic cell without liquid junction, Eq. 14.3.13 provides a way to evaluate $\Delta_r G$ under given conditions. If the reaction can only be carried out in a cell with a liquid junction, Eq. 14.3.14 can be used for this purpose provided that the liquid junction potential E_j can be assumed to be negligible or can be estimated from theory.

Note that the cell has reaction equilibrium only if $\Delta_r G$ is zero. The cell has thermal, mechanical, and transfer equilibrium when the electric current is zero and the cell potential is the zero-current cell potential $E_{\text{cell,eq}}$. Equations 14.3.13 and 14.3.14 show that in order for the cell to also have reaction equilibrium, $E_{\text{cell,eq}}$ must equal the liquid junction potential if there is a liquid junction, or be zero otherwise. These are the conditions of an exhausted, “dead” cell that can no longer do electrical work.

14.3.3 Standard molar reaction quantities

Consider a hypothetical galvanic cell in which each reactant and product of the cell reaction is in its standard state at unit activity, and in which a liquid junction if present has a negligible liquid junction potential. The equilibrium cell potential of this cell is called the **standard cell potential** of the cell reaction, $E_{\text{cell,eq}}^\circ$. An experimental procedure for evaluating $E_{\text{cell,eq}}^\circ$ will be described in Sec. 14.5.

In this hypothetical cell, $\Delta_r G_{\text{cell}}$ is equal to the standard molar reaction Gibbs energy $\Delta_r G^\circ$. From Eq. 14.3.13, or Eq. 14.3.14 with E_j assumed equal to zero, we have

$$\Delta_r G^\circ = -zFE_{\text{cell,eq}}^\circ \quad (14.3.15)$$

$\Delta_r G^\circ$ is the molar reaction Gibbs energy when each reactant and product is at unit activity and, if it is an ion, is in a phase of zero electric potential. Since $\Delta_r G^\circ$ is equal to $-RT \ln K$ (Eq. 11.8.10), we can write

$$\ln K = \frac{zF}{RT} E_{\text{cell,eq}}^\circ \quad (14.3.16)$$

Equation 14.3.16 allows us to evaluate the thermodynamic equilibrium constant K of the cell reaction by a noncalorimetric method. Consider for example the cell

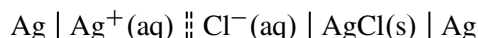

in which the pair of dashed vertical bars indicates a liquid junction of negligible liquid junction potential. The electrode reactions are

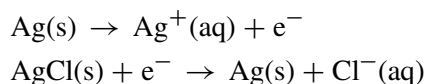

and the cell reaction is

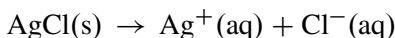

The equilibrium constant of this reaction is the solubility product K_s of silver chloride (Sec. 12.5.5). At 298.15 K, the standard cell potential is found to be $E_{\text{cell,eq}}^\circ = -0.5770$ V. We can use this value in Eq. 14.3.16 to evaluate K_s at 298.15 K (see Prob. 14.5).

Equation 14.3.16 also allows us to evaluate the standard molar reaction enthalpy by substitution in Eq. 12.1.13 on page 369:

$$\begin{aligned} \Delta_r H^\circ &= RT^2 \frac{d \ln K}{dT} \\ &= zF \left(T \frac{dE_{\text{cell,eq}}^\circ}{dT} - E_{\text{cell,eq}}^\circ \right) \end{aligned} \quad (14.3.17)$$

(no solute standard states based on concentration)

Finally, by combining Eqs. 14.3.15 and 14.3.17 with $\Delta_r G^\circ = \Delta_r H^\circ - T\Delta_r S^\circ$, we obtain an expression for the standard molar reaction entropy:

$$\Delta_r S^\circ = zF \frac{dE_{\text{cell,eq}}^\circ}{dT} \quad (14.3.18)$$

(no solute standard states based on concentration)

Because G , H , and S are state functions, the thermodynamic equilibrium constant and the molar reaction quantities evaluated from $E_{\text{cell,eq}}^\circ$ and $dE_{\text{cell,eq}}^\circ/dT$ are the same quantities as those for the reaction when it takes place in a reaction vessel instead of in a galvanic cell. However, the heats at constant T and p are not the same (page 320). During a reversible cell reaction, dS must equal $\delta q/T$, and $\delta q/d\xi$ is therefore equal to $T\Delta_r S^\circ$ during a cell reaction taking place reversibly under standard state conditions at constant T and p .

14.4 The Nernst Equation

The standard cell potential $E_{\text{cell,eq}}^\circ$ of a cell reaction is the equilibrium cell potential of the hypothetical galvanic cell in which each reactant and product of the cell reaction is in its standard state and there is no liquid junction potential. The value of $E_{\text{cell,eq}}^\circ$ for a given cell reaction with given choices of standard states is a function only of temperature. The measured equilibrium cell potential $E_{\text{cell,eq}}$ of an actual cell, however, depends on the activities of the reactants and products as well as on temperature and the liquid junction potential, if present.

To derive a relation between $E_{\text{cell,eq}}$ and activities for a cell without liquid junction, or with a liquid junction of negligible liquid junction potential, we substitute expressions for $\Delta_r G$ and for $\Delta_r G^\circ$ from Eqs. 14.3.13 and Eq. 14.3.15 into $\Delta_r G = \Delta_r G^\circ + RT \ln Q_{\text{rxn}}$ (Eq. 11.8.8 on page 352) and solve for $E_{\text{cell,eq}}$:

$$E_{\text{cell,eq}} = E_{\text{cell,eq}}^\circ - \frac{RT}{zF} \ln Q_{\text{rxn}} \quad (14.4.1)$$

(no liquid junction, or $E_j=0$)

Equation 14.4.1 is the **Nernst equation** for the cell reaction. Here Q_{rxn} is the reaction quotient for the cell reaction defined by Eq. 11.8.6: $Q_{\text{rxn}} = \prod_i a_i^{v_i}$.

The rest of this section will assume that the cell reaction takes place in a cell without liquid junction, or in one in which E_j is negligible.

If each reactant and product of the cell reaction is in its standard state, then each activity is unity and $\ln Q_{\text{rxn}}$ is zero. We can see from the Nernst equation that the equilibrium cell potential $E_{\text{cell,eq}}$ in this case has its standard value $E_{\text{cell,eq}}^\circ$, as expected. A decrease in product activities or an increase in reactant activities decreases the value of $\ln Q_{\text{rxn}}$ and increases $E_{\text{cell,eq}}$, as we would expect since $E_{\text{cell,eq}}$ should be greater when the forward cell reaction has a greater tendency for spontaneity.

If the cell reaction comes to reaction equilibrium, as it will if we short-circuit the cell terminals with an external wire, the value of Q_{rxn} becomes equal to the thermodynamic equilibrium constant K , and the Nernst equation becomes $E_{\text{cell,eq}} = E_{\text{cell,eq}}^\circ - (RT/zF) \ln K$. The term $(RT/zF) \ln K$ is equal to $E_{\text{cell,eq}}^\circ$ (Eq. 14.3.16), so $E_{\text{cell,eq}}$ becomes zero—the cell is “dead” and is incapable of performing electrical work on the surroundings.

At $T=298.15$ K (25.00 °C), the value of RT/F is 0.02569 V, and we can write the Nernst equation in the compact form

$$E_{\text{cell,eq}} = E_{\text{cell,eq}}^\circ - \frac{0.02569 \text{ V}}{z} \ln Q_{\text{rxn}} \quad (14.4.2)$$

($T=298.15$ K)

As an illustration of an application of the Nernst equation, consider the reaction equation

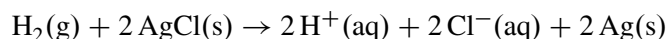

This reaction takes place in a cell without liquid junction (Fig. 14.1), and the electrolyte solution can be aqueous HCl. The expression for the reaction quotient is

$$Q_{\text{rxn}} = \frac{a_+^2 a_-^2 a_{\text{Ag}}^2}{a_{\text{H}_2} a_{\text{AgCl}}^2} \quad (14.4.3)$$

We may usually with negligible error approximate the pressure factors of the solids and solutes by unity. The activities of the solids are then 1, the solute activities are $a_+ = \gamma_+ m_+ / m^\circ$ and $a_- = \gamma_- m_- / m^\circ$, and the hydrogen activity is $a_{\text{H}_2} = f_{\text{H}_2} / p^\circ$. The ion molalities m_+ and m_- are equal to the HCl molality m_{B} . The expression for Q_{rxn} becomes

$$Q_{\text{rxn}} = \frac{\gamma_+^2 \gamma_-^2 (m_{\text{B}} / m^\circ)^4}{f_{\text{H}_2} / p^\circ} = \frac{\gamma_{\pm}^4 (m_{\text{B}} / m^\circ)^4}{f_{\text{H}_2} / p^\circ} \quad (14.4.4)$$

and the Nernst equation for this cell is

$$\begin{aligned} E_{\text{cell, eq}} &= E_{\text{cell, eq}}^\circ - \frac{RT}{2F} \ln \frac{\gamma_{\pm}^4 (m_{\text{B}} / m^\circ)^4}{f_{\text{H}_2} / p^\circ} \\ &= E_{\text{cell, eq}}^\circ - \frac{2RT}{F} \ln \gamma_{\pm} - \frac{2RT}{F} \ln \frac{m_{\text{B}}}{m^\circ} + \frac{RT}{2F} \ln \frac{f_{\text{H}_2}}{p^\circ} \end{aligned} \quad (14.4.5)$$

By measuring $E_{\text{cell, eq}}$ for a cell with known values of m_{B} and f_{H_2} , and with a derived value of $E_{\text{cell, eq}}^\circ$, we can use this equation to find the mean ionic activity coefficient γ_{\pm} of the HCl solute. This is how the experimental curve for aqueous HCl in Fig. 10.3 on page 298 was obtained.

We can always multiply each of the stoichiometric coefficients of a reaction equation by the same positive constant without changing the meaning of the reaction. How does this affect the Nernst equation for the reaction equation above? Suppose we decide to multiply the stoichiometric coefficients by one-half:

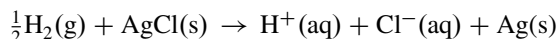

With this changed reaction equation, the value of z is changed from 2 to 1 and the Nernst equation becomes

$$E_{\text{cell, eq}} = E_{\text{cell, eq}}^\circ - \frac{RT}{F} \ln \frac{\gamma_{\pm}^2 (m_{\text{B}} / m^\circ)^2}{(f_{\text{H}_2} / p^\circ)^{1/2}} \quad (14.4.6)$$

which yields the same value of $E_{\text{cell, eq}}$ for given cell conditions as Eq. 14.4.5. This value must of course be unchanged, because physically the cell is the same no matter how we write its cell reaction, and measurable physical quantities such as $E_{\text{cell, eq}}$ are unaffected. However, molar reaction quantities such as $\Delta_{\text{r}}G$ and $\Delta_{\text{r}}G^\circ$ do depend on how we write the cell reaction, because they are changes per extent of reaction.

14.5 Evaluation of the Standard Cell Potential

As we have seen, the value of the standard cell potential $E_{\text{cell, eq}}^\circ$ of a cell reaction has useful thermodynamic applications. The value of $E_{\text{cell, eq}}^\circ$ for a given cell reaction depends only on temperature. To evaluate it, we can extrapolate an appropriate function to infinite dilution where ionic activity coefficients are unity.

To see how this procedure works, consider again the cell reaction $\text{H}_2(\text{g}) + 2 \text{AgCl}(\text{s}) \rightarrow 2 \text{H}^+(\text{aq}) + 2 \text{Cl}^-(\text{aq}) + 2 \text{Ag}(\text{s})$. The cell potential depends on the molality m_{B} of the HCl solute according to Eq. 14.4.5. We can rearrange the equation to

$$E_{\text{cell, eq}}^\circ = E_{\text{cell, eq}} + \frac{2RT}{F} \ln \gamma_{\pm} + \frac{2RT}{F} \ln \frac{m_{\text{B}}}{m^\circ} - \frac{RT}{2F} \ln \frac{f_{\text{H}_2}}{p^\circ} \quad (14.5.1)$$

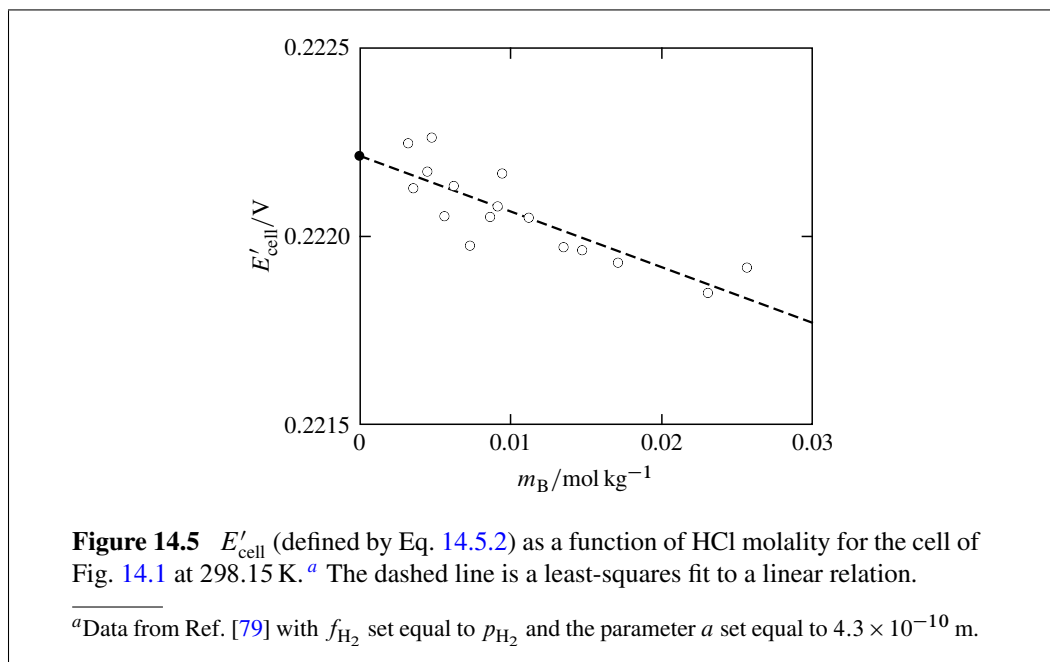

For given conditions of the cell, we can measure all quantities on the right side of Eq. 14.5.1 except the mean ionic activity coefficient γ_{\pm} of the electrolyte. We cannot know the exact value of $\ln \gamma_{\pm}$ for any given molality until we have evaluated $E_{\text{cell,eq}}^{\circ}$. We do know that as m_{B} approaches zero, γ_{\pm} approaches unity and $\ln \gamma_{\pm}$ must approach zero. The Debye–Hückel formula of Eq. 10.4.7 on page 297 is a theoretical expression for $\ln \gamma_{\pm}$ that more closely approximates the actual value the lower is the ionic strength. Accordingly, we define the quantity

$$E'_{\text{cell}} = E_{\text{cell,eq}} + \frac{2RT}{F} \left(-\frac{A\sqrt{m_{\text{B}}}}{1 + Ba\sqrt{m_{\text{B}}}} \right) + \frac{2RT}{F} \ln \frac{m_{\text{B}}}{m^{\circ}} - \frac{RT}{2F} \ln \frac{f_{\text{H}_2}}{p^{\circ}} \quad (14.5.2)$$

The expression in parentheses is the Debye–Hückel formula for $\ln \gamma_{\pm}$ with I_m replaced by m_{B} . The constants A and B have known values at any temperature (Sec. 10.4), and a is an ion-size parameter for which we can choose a reasonable value. At a given temperature, we can evaluate E'_{cell} experimentally as a function of m_{B} .

The expression on the right side of Eq. 14.5.1 differs from that of Eq. 14.5.2 by contributions to $(2RT/F) \ln \gamma_{\pm}$ not accounted for by the Debye–Hückel formula. Since these contributions approach zero in the limit of infinite dilution, the extrapolation of measured values of E'_{cell} to $m_{\text{B}}=0$ yields the value of $E_{\text{cell,eq}}^{\circ}$.

Figure 14.5 shows this extrapolation using data from the literature. The extrapolated value indicated by the filled circle is $E_{\text{cell,eq}}^{\circ} = 0.2222$ V, and the uncertainty is on the order of only 0.1 mV.

14.6 Standard Electrode Potentials

Section 14.5 explained how, by measuring the equilibrium cell potential of a galvanic cell at different electrolyte molalities, we can evaluate the standard cell potential $E_{\text{cell,eq}}^{\circ}$ of the

cell reaction. It is not necessary to carry out this involved experimental procedure for each individual cell reaction of interest. Instead, we can calculate $E_{\text{cell, eq}}^{\circ}$ from standard electrode potentials.

By convention, standard electrode potentials use a standard hydrogen electrode as a reference electrode. A **standard hydrogen electrode** is a hydrogen electrode, such as the electrode shown at the left in Fig. 14.1, in which the species $\text{H}_2(\text{g})$ and $\text{H}^+(\text{aq})$ are in their standard states. Since these are *hypothetical* gas and solute standard states, the standard hydrogen electrode is a hypothetical electrode—not one we can actually construct in the laboratory.

A **standard electrode potential** E° is defined as the standard cell potential of a cell with a hydrogen electrode at the left and the electrode of interest at the right. For example, the cell in Fig. 14.1 with cell diagram

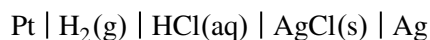

has a hydrogen electrode at the left and a silver–silver chloride electrode at the right. The standard electrode potential of the silver–silver chloride electrode, therefore, is equal to the standard cell potential of this cell.

Since a cell with hydrogen electrodes at both the left and right has a standard cell potential of zero, the standard electrode potential of the hydrogen electrode is *zero* at all temperatures. The standard electrode potential of any other electrode is nonzero and is a function only of temperature.

Consider the following three cells constructed from various combinations of three different electrodes: a hydrogen electrode, and two electrodes denoted L and R.

- Cell 1 has electrode L at the left and electrode R at the right.
- Cell 2 has the hydrogen electrode at the left and electrode L at the right; its standard cell potential is the standard electrode potential E_{L}° of electrode L.
- Cell 3 has the hydrogen electrode at the left and electrode R at the right; its standard cell potential is the standard electrode potential E_{R}° of electrode R.

We wish to calculate the standard cell potential $E_{\text{cell, eq}}^{\circ}$ of cell 1 from the standard electrode potentials E_{L}° and E_{R}° .

If we write the cell reactions of cells 1 and 2 using the same value of the electron number z for both, we find that their sum is the cell reaction for cell 3 with the same value of z . Call these reactions 1, 2, and 3, respectively:



The relation of Eq. 14.6.1 shows that an infinitesimal advancement $d\xi$ of reaction 1 combined with an equal advancement of reaction 2 causes the same changes in amounts as the advancement $d\xi$ of reaction 3. Because $\Delta_{\text{r}}G^{\circ}$ for each reaction is the rate at which G changes with ξ at constant T when the reactants and products are in their standard states, the following relation applies when the reactions take place at the same temperature:

$$\Delta_{\text{r}}G^{\circ}(\text{reaction 1}) + \Delta_{\text{r}}G^{\circ}(\text{reaction 2}) = \Delta_{\text{r}}G^{\circ}(\text{reaction 3}) \quad (14.6.2)$$

Making the substitution $\Delta_{\text{r}}G^{\circ} = -zFE_{\text{cell, eq}}^{\circ}$ (Eq. 14.3.15), with the same value of z for each reaction, gives us $E_{\text{cell, eq}}^{\circ} + E_{\text{L}}^{\circ} = E_{\text{R}}^{\circ}$, or

$$E_{\text{cell, eq}}^{\circ} = E_{\text{R}}^{\circ} - E_{\text{L}}^{\circ} \quad (14.6.3)$$

where $E_{\text{cell, eq}}^{\circ}$, E_{R}° , and E_{L}° all refer to cell 1.

Equation 14.6.3 is a general relation applicable to any galvanic cell. It should be apparent that we can use the relation to calculate the standard electrode potential of an electrode from the standard electrode potential of a different electrode and the standard cell potential of a cell that contains both electrodes. Neither electrode has to be a hydrogen electrode, which is difficult to work with experimentally.

Using Eq. 14.6.3 to calculate standard cell potentials from standard electrode potentials saves a lot of experimental work. For example, measurement of $E_{\text{cell, eq}}^{\circ}$ for ten different cells, only one of which needs to include a hydrogen electrode, provides values of E° for ten electrodes other than $E^{\circ}=0$ for the hydrogen electrode. From these ten values of E° , values of $E_{\text{cell, eq}}^{\circ}$ can be calculated for 35 other cells without hydrogen electrodes.

PROBLEMS

An underlined problem number or problem-part letter indicates that the numerical answer appears in Appendix I.

- 14.1** The state of a galvanic cell without liquid junction, when its temperature and pressure are uniform, can be fully described by values of the variables T , p , and ξ . Find an expression for dG during a reversible advancement of the cell reaction, and use it to derive the relation $\Delta_r G_{\text{cell}} = -zFE_{\text{cell,eq}}$ (Eq. 14.3.8). (Hint: Eq. 3.8.8.)
- 14.2** Before 1982 the standard pressure was usually taken as 1 atm. For the cell shown in Fig. 14.1, what correction is needed, for a value of $E_{\text{cell,eq}}^\circ$ obtained at 25 °C and using the older convention, to change the value to one corresponding to a standard pressure of 1 bar? Equation 14.3.15 can be used for this calculation.
- 14.3** Careful measurements⁴ of the equilibrium cell potential of the cell

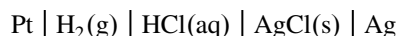

yielded, at 298.15 K and using a standard pressure of 1 bar, the values $E_{\text{cell,eq}}^\circ = 0.22217 \text{ V}$ and $dE_{\text{cell,eq}}^\circ/dT = -6.462 \times 10^{-4} \text{ V K}^{-1}$. (The requested calculated values are close to, but not exactly the same as, the values listed in Appendix H, which are based on the same data combined with data of other workers.)

- (a) Evaluate $\Delta_r G^\circ$, $\Delta_r S^\circ$, and $\Delta_r H^\circ$ at 298.15 K for the reaction

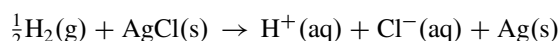

- (b) Problem 12.18 showed how the standard molar enthalpy of formation of the aqueous chloride ion may be evaluated based on the convention $\Delta_f H^\circ(\text{H}^+, \text{aq}) = 0$. If this value is combined with the value of $\Delta_r H^\circ$ obtained in part (a) of the present problem, the standard molar enthalpy of formation of crystalline silver chloride can be evaluated. Carry out this calculation for $T = 298.15 \text{ K}$ using the value $\Delta_f H^\circ(\text{Cl}^-, \text{aq}) = -167.08 \text{ kJ mol}^{-1}$ (Appendix H).
- (c) By a similar procedure, evaluate the standard molar entropy, the standard molar entropy of formation, and the standard molar Gibbs energy of formation of crystalline silver chloride at 298.15 K. You need the following standard molar entropies evaluated from spectroscopic and calorimetric data:

$$\begin{array}{ll} S_m^\circ(\text{H}_2, \text{g}) = 130.68 \text{ J K}^{-1} \text{ mol}^{-1} & S_m^\circ(\text{Cl}_2, \text{g}) = 223.08 \text{ J K}^{-1} \text{ mol}^{-1} \\ S_m^\circ(\text{Cl}^-, \text{aq}) = 56.60 \text{ J K}^{-1} \text{ mol}^{-1} & S_m^\circ(\text{Ag, s}) = 42.55 \text{ J K}^{-1} \text{ mol}^{-1} \end{array}$$

- 14.4** The standard cell potential of the cell



has been determined over a range of temperature.⁵ At $T=298.15 \text{ K}$, the standard cell potential was found to be $E_{\text{cell,eq}}^\circ = 1.13579 \text{ V}$, and its temperature derivative was found to be $dE_{\text{cell,eq}}^\circ/dT = -5.9863 \times 10^{-4} \text{ V K}^{-1}$.

- (a) Write the cell reaction for this cell.

⁴Ref. [4]. ⁵Ref. [55].

- (b) Use the data to evaluate the standard molar enthalpy of formation and the standard molar Gibbs energy of formation of crystalline silver chloride at 298.15 K. (Note that this calculation provides values of quantities also calculated in Prob. 14.3 using independent data.)

14.5 Use data in Sec. 14.3.3 to evaluate the solubility product of silver chloride at 298.15 K.

14.6 The equilibrium cell potential of the galvanic cell



is found to be $E_{\text{cell, eq}} = 1.410 \text{ V}$ at 298.15 K. The standard cell potential is $E_{\text{cell, eq}}^\circ = 1.360 \text{ V}$.

- (a) Write the cell reaction and calculate its thermodynamic equilibrium constant at 298.15 K.
- (b) Use the cell measurement to calculate the mean ionic activity coefficient of aqueous HCl at 298.15 K and a molality of $0.500 \text{ mol kg}^{-1}$.
- 14.7** Consider the following galvanic cell, which combines a hydrogen electrode and a calomel electrode:



- (a) Write the cell reaction.
- (b) At 298.15 K, the standard cell potential of this cell is $E_{\text{cell, eq}}^\circ = 0.2680 \text{ V}$. Using the value of $\Delta_f G^\circ$ for the aqueous chloride ion in Appendix H, calculate the standard molar Gibbs energy of formation of crystalline mercury(I) chloride (calomel) at 298.15 K.
- (c) Calculate the solubility product of mercury(I) chloride at 298.15 K. The dissolution equilibrium is $\text{Hg}_2\text{Cl}_2(\text{s}) \rightleftharpoons \text{Hg}_2^{2+}(\text{aq}) + 2 \text{Cl}^-(\text{aq})$. Take values for the standard molar Gibbs energies of formation of the aqueous ions from Appendix H.

Table 14.1 Equilibrium cell potential as a function of HBr molality m_B .

$m_B / (\text{mol kg}^{-1})$	$E_{\text{cell, eq}} / \text{V}$
0.0004042	0.47381
0.0008444	0.43636
0.0008680	0.43499
0.0013554	0.41243
0.001464	0.40864
0.001850	0.39667
0.002396	0.38383
0.003719	0.36173

14.8 Table 14.1 lists equilibrium cell potentials obtained with the following cell at 298.15 K:⁶



Use these data to evaluate the standard electrode potential of the silver-silver bromide electrode at this temperature to the nearest millivolt. (Since the electrolyte solutions are quite dilute, you may ignore the term $Ba\sqrt{m_B}$ in Eq. 14.5.2.)

⁶Ref. [98].

14.9 The cell diagram of a mercury cell can be written



- (a) Write the electrode reactions and cell reaction with electron number $z = 2$.
- (b) Use data in Appendix H to calculate the standard molar reaction quantities $\Delta_r H^\circ$, $\Delta_r G^\circ$, and $\Delta_r S^\circ$ for the cell reaction at 298.15 K.
- (c) Calculate the standard cell potential of the mercury cell at 298.15 K to the nearest 0.01 V.
- (d) Evaluate the ratio of heat to advancement, $\ddagger q / d\xi$, at a constant temperature of 298.15 K and a constant pressure of 1 bar, for the cell reaction taking place in two different ways: reversibly in the cell, and spontaneously in a reaction vessel that is not part of an electrical circuit.
- (e) Evaluate $dE_{\text{cell,eq}}^\circ / dT$, the temperature coefficient of the standard cell potential.

APPENDIX A

DEFINITIONS OF THE SI BASE UNITS

This appendix gives two definitions for each of the seven SI base units. The *previous definitions* are from the 2007 IUPAC Green Book.¹ The *revised definitions* are from the SI revision effective beginning 20 May 2019.² Values of the defining constants referred to in the revised definitions are listed in Appendix B.

The **second**, symbol *s*, is the SI unit of time.

- **Previous definition:** The second is the duration of 9 192 631 770 periods of the radiation corresponding to the transition between the two hyperfine levels of the ground state of the cesium-133 atom.
- **Revised definition:** No change from the previous definition. The number 9 192 631 770 is the numerical value of the defining constant $\Delta\nu_{\text{Cs}}$ expressed in units of s^{-1} .

The **meter**,³ symbol *m*, is the SI unit of length.

- **Previous definition:** The meter is the length of path traveled by light in vacuum during a time interval of $1/(299\,792\,458)$ of a second.
- **Revised definition:** No change from the previous definition. The number 299 792 458 is the numerical value of the defining constant c expressed in units of m s^{-1} .

The **kilogram**, symbol *kg*, is the SI unit of mass.

- **Previous definition:** The kilogram is equal to the mass of the international prototype of the kilogram in Sèvres, France.
- **Revised definition:** The kilogram is defined using the defining constant h and the definitions of second and meter.

The **kelvin**, symbol *K*, is the SI unit of thermodynamic temperature.

- **Previous definition:** The kelvin is the fraction $1/273.16$ of the thermodynamic temperature of the triple point of water.
- **Revised definition:** The kelvin is equal to the change of thermodynamic temperature T that results in a change of the translational energy $(3/2)kT$ of an ideal gas molecule by $(3/2)1.380\,649 \times 10^{-23}$ J. The number $1.380\,649 \times 10^{-23}$ is the numerical value of the defining constant k expressed in units of J K^{-1} .

¹Ref. [36], Sec. 3.3.

²Ref. [165]

³An alternative spelling is *metre*.

The **mole**, symbol mol, is the SI unit of amount of substance.

- **Previous definition:** The mole is the amount of substance of a system which contains as many elementary entities as there are atoms in 0.012 kilogram of carbon 12.
- **Revised definition:** One mole contains exactly $6.022\,140\,76 \times 10^{23}$ elementary entities. This number is the numerical value of the defining constant N_A expressed in the unit mol^{-1} .

The **ampere**, symbol A, is the SI unit of electric current.

- **Previous definition:** The ampere is that constant current which, if maintained in two straight parallel conductors of infinite length, of negligible circular cross-section, and placed 1 meter apart in vacuum, would produce between these conductors a force equal to 2×10^{-7} newton per meter of length.
- **Revised definition:** The ampere is defined as the electric current in which $1/(1.602\,176\,634 \times 10^{-19})$ elementary charges travel across a given point in one second. The number $1.602\,176\,634 \times 10^{-19}$ is the numerical value of the defining constant e expressed in coulombs.

The **candela**, symbol cd, is the SI unit of luminous intensity.

- **Previous definition:** The candela is the luminous intensity, in a given direction, of a source that emits monochromatic radiation of frequency $540 \times 10^{12} \text{ s}^{-1}$ and that has a radiant intensity in that direction of $(1/683) \text{ m}^2 \text{ kg s}^{-3}$ per steradian.
- **Revised definition:** No change from the previous definition. The meter, kilogram, and second in this definition are defined in terms of the defining constants c , h , and $\Delta\nu_{\text{CS}}$.

APPENDIX B

PHYSICAL CONSTANTS

The following table lists values of fundamental physical constants used to define SI base units or needed in thermodynamic calculations. The 2019 SI revision treats the first six constants ($\Delta\nu_{\text{Cs}}$ through N_{A}) as *defining constants* or *fundamental constants* whose values are exact by definition.

Constant	Symbol	Value in SI units
cesium-133 hyperfine transition frequency	$\Delta\nu_{\text{Cs}}$	$9.192\,631\,770 \times 10^9 \text{ s}^{-1}$
speed of light in vacuum	c	$2.997\,924\,58 \times 10^8 \text{ m s}^{-1}$
Planck constant	h	$6.626\,070\,15 \times 10^{-34} \text{ J s}$
elementary charge	e	$1.602\,176\,634 \times 10^{-19} \text{ C}$
Boltzmann constant	k	$1.380\,649 \times 10^{-23} \text{ J K}^{-1}$
Avogadro constant	N_{A}	$6.022\,140\,76 \times 10^{23} \text{ mol}^{-1}$
gas constant ^a	R	$8.314\,462 \dots \text{ J K}^{-1} \text{ mol}^{-1}$
Faraday constant ^b	F	$9.648\,533 \dots \times 10^4 \text{ C mol}^{-1}$
electric constant ^c	ϵ_0	$8.854\,187 \dots \times 10^{-12} \text{ C}^2 \text{ J}^{-1} \text{ m}^{-1}$
standard acceleration of free fall ^d	g_{n}	$9.806\,65 \text{ m s}^{-2}$

^aor molar gas constant; R is equal to $N_{\text{A}}k$

^b F is equal to $N_{\text{A}}e$

^cor permittivity of vacuum; ϵ_0 is equal to $10^{-7}/(4\pi c^2)$

^dor standard acceleration of gravity

APPENDIX C

SYMBOLS FOR PHYSICAL QUANTITIES

This appendix lists the symbols for most of the variable physical quantities used in this book. The symbols are those recommended in the IUPAC Green Book (Ref. [127]) except for quantities followed by an asterisk (*).

Symbol	Physical quantity	SI unit
<i>Roman letters</i>		
<i>A</i>	Helmholtz energy	J
<i>A_r</i>	relative atomic mass (atomic weight)	(dimensionless)
<i>A_s</i>	surface area	m ²
<i>a</i>	activity	(dimensionless)
<i>B</i>	second virial coefficient	m ³ mol ⁻¹
<i>C</i>	number of components*	(dimensionless)
<i>C_p</i>	heat capacity at constant pressure	J K ⁻¹
<i>C_v</i>	heat capacity at constant volume	J K ⁻¹
<i>c</i>	concentration	mol m ⁻³
<i>E</i>	energy	J
	electrode potential	V
<i>E</i>	electric field strength	V m ⁻¹
<i>E_{cell}</i>	cell potential	V
<i>E_j</i>	liquid junction potential	V
<i>E_{sys}</i>	system energy in a lab frame	J
<i>F</i>	force	N
	number of degrees of freedom*	(dimensionless)
<i>f</i>	fugacity	Pa
<i>g</i>	acceleration of free fall	m s ⁻²
<i>G</i>	Gibbs energy	J
<i>h</i>	height, elevation	m
<i>H</i>	enthalpy	J
<i>H</i>	magnetic field strength	A m ⁻¹
<i>I</i>	electric current	A
<i>I_m</i>	ionic strength, molality basis	mol kg ⁻¹
<i>I_c</i>	ionic strength, concentration basis	mol m ⁻³

(continued from previous page)

Symbol	Physical quantity	SI unit
K	thermodynamic equilibrium constant	(dimensionless)
K_a	acid dissociation constant	(dimensionless)
K_p	equilibrium constant, pressure basis	$\text{Pa}^{\sum \nu}$
K_s	solubility product	(dimensionless)
$k_{H,i}$	Henry's law constant of species i , mole fraction basis	Pa
$k_{C,i}$	Henry's law constant of species i , concentration basis*	$\text{Pa m}^3 \text{ mol}^{-1}$
$k_{m,i}$	Henry's law constant of species i , molality basis*	Pa kg mol^{-1}
l	length, distance	m
L	relative partial molar enthalpy*	J mol^{-1}
M	molar mass	kg mol^{-1}
\mathbf{M}	magnetization	A m^{-1}
M_r	relative molecular mass (molecular weight)	(dimensionless)
m	mass	kg
m_i	molality of species i	mol kg^{-1}
N	number of entities (molecules, atoms, ions, formula units, etc.)	(dimensionless)
n	amount of substance	mol
P	number of phases*	(dimensionless)
p	pressure	Pa
	partial pressure	Pa
\mathbf{P}	dielectric polarization	C m^{-2}
Q	electric charge	C
Q_{sys}	charge entering system at right conductor*	C
Q_{rxn}	reaction quotient*	(dimensionless)
q	heat	J
R_{el}	electric resistance*	Ω
S	entropy	J K^{-1}
s	solubility	mol m^{-3}
	number of species*	(dimensionless)
T	thermodynamic temperature	K
t	time	s
	Celsius temperature	$^{\circ}\text{C}$
U	internal energy	J
V	volume	m^3
v	specific volume	$\text{m}^3 \text{ kg}^{-1}$
	velocity, speed	m s^{-1}
w	work	J
	mass fraction (weight fraction)	(dimensionless)
w_{el}	electrical work*	J

(continued from previous page)

Symbol	Physical quantity	SI unit
w'	nonexpansion work*	J
x	mole fraction in a phase	(dimensionless)
	Cartesian space coordinate	m
y	mole fraction in gas phase	(dimensionless)
	Cartesian space coordinate	m
Z	compression factor (compressibility factor)	(dimensionless)
z	mole fraction in multiphase system*	(dimensionless)
	charge number of an ion	(dimensionless)
	electron number of cell reaction	(dimensionless)
	Cartesian space coordinate	m
<i>Greek letters</i>		
<i>alpha</i>		
α	degree of reaction, dissociation, etc.	(dimensionless)
	cubic expansion coefficient	K ⁻¹
<i>gamma</i>		
γ	surface tension	N m ⁻¹ , J m ⁻²
γ_i	activity coefficient of species i , pure liquid or solid standard state*	(dimensionless)
$\gamma_{m,i}$	activity coefficient of species i , molality basis	(dimensionless)
$\gamma_{c,i}$	activity coefficient of species i , concentration basis	(dimensionless)
$\gamma_{x,i}$	activity coefficient of species i , mole fraction basis	(dimensionless)
γ_{\pm}	mean ionic activity coefficient	(dimensionless)
Γ	pressure factor (activity of a reference state)*	(dimensionless)
<i>epsilon</i>		
ϵ	efficiency of a heat engine	(dimensionless)
	energy equivalent of a calorimeter*	J K ⁻¹
<i>theta</i>		
ϑ	angle of rotation	(dimensionless)
<i>kappa</i>		
κ	reciprocal radius of ionic atmosphere	m ⁻¹
κ_T	isothermal compressibility	Pa ⁻¹
<i>mu</i>		
μ	chemical potential	J mol ⁻¹
μ_{JT}	Joule–Thomson coefficient	K Pa ⁻¹
<i>nu</i>		
ν	number of ions per formula unit	(dimensionless)
	stoichiometric number	(dimensionless)
ν_+	number of cations per formula unit	(dimensionless)

(continued from previous page)

Symbol	Physical quantity	SI unit
ν_-	number of anions per formula unit	(dimensionless)
x_i		
ξ	advancement (extent of reaction)	mol
p_i		
Π	osmotic pressure	Pa
ρ	density	kg m^{-3}
τ	torque*	J
ϕ	fugacity coefficient	(dimensionless)
	electric potential	V
$\Delta\phi$	electric potential difference	V
ϕ_m	osmotic coefficient, molality basis	(dimensionless)
Φ_L	relative apparent molar enthalpy of solute*	J mol^{-1}
ω	angular velocity	s^{-1}

APPENDIX D

MISCELLANEOUS ABBREVIATIONS AND SYMBOLS

D.1 Physical States

These abbreviations for physical states (states of aggregation) may be appended in parentheses to chemical formulas or used as superscripts to symbols for physical quantities. All but “mixt” are listed in the IUPAC Green Book (Ref. [36], p. 54).

g	gas or vapor
l	liquid
f	fluid (gas or liquid)
s	solid
cd	condensed phase (liquid or solid)
cr	crystalline
mixt	mixture
sln	solution
aq	aqueous solution
aq, ∞	aqueous solution at infinite dilution

D.2 Subscripts for Chemical Processes

These abbreviations are used as subscripts to the Δ symbol. They are listed in the IUPAC Green Book (Ref. [36], p. 59–60).

The combination Δ_p , where “p” is any one of the abbreviations below, can be interpreted as an operator: $\Delta_p \stackrel{\text{def}}{=} \partial/\partial\xi_p$ where ξ_p is the advancement of the given process at constant temperature and pressure. For example, $\Delta_c H = (\partial H/\partial\xi_c)_{T,p}$ is the molar differential enthalpy of combustion.

vap	vaporization, evaporation (l \rightarrow g)
sub	sublimation (s \rightarrow g)
fus	melting, fusion (s \rightarrow l)
trs	transition between two phases
mix	mixing of fluids
sol	solution of a solute in solvent
dil	dilution of a solution
ads	adsorption
dpl	displacement
imm	immersion
r	reaction in general
at	atomization
c	combustion reaction
f	formation reaction

D.3 Superscripts

These abbreviations and symbols are used as superscripts to symbols for physical quantities. All but $'$, int, and ref are listed as recommended superscripts in the IUPAC Green Book (Ref. [36], p. 60).

$^{\circ}$	standard
$*$	pure substance
$'$	Legendre transform of a thermodynamic potential
∞	infinite dilution
id	ideal
int	integral
E	excess quantity
ref	reference state

APPENDIX E

CALCULUS REVIEW

E.1 Derivatives

Let f be a function of the variable x , and let Δf be the change in f when x changes by Δx . Then the **derivative** df/dx is the ratio $\Delta f/\Delta x$ in the limit as Δx approaches zero. The derivative df/dx can also be described as the rate at which f changes with x , and as the slope of a curve of f plotted as a function of x .

The following is a short list of formulas likely to be needed. In these formulas, u and v are arbitrary functions of x , and a is a constant.

$$\begin{aligned}\frac{d(u^a)}{dx} &= au^{a-1} \frac{du}{dx} \\ \frac{d(uv)}{dx} &= u \frac{dv}{dx} + v \frac{du}{dx} \\ \frac{d(u/v)}{dx} &= \left(\frac{1}{v^2}\right) \left(v \frac{du}{dx} - u \frac{dv}{dx}\right) \\ \frac{d \ln(ax)}{dx} &= \frac{1}{x} \\ \frac{d(e^{ax})}{dx} &= ae^{ax} \\ \frac{df(u)}{dx} &= \frac{df(u)}{du} \cdot \frac{du}{dx}\end{aligned}$$

E.2 Partial Derivatives

If f is a function of the independent variables x , y , and z , the **partial derivative** $(\partial f/\partial x)_{y,z}$ is the derivative df/dx with y and z held constant. It is important in thermodynamics to indicate the variables that are held constant, as $(\partial f/\partial x)_{y,z}$ is not necessarily equal to $(\partial f/\partial x)_{a,b}$ where a and b are variables different from y and z .

The variables shown at the bottom of a partial derivative should tell you which variables are being used as the independent variables. For example, if the partial derivative is $\left(\frac{\partial f}{\partial y}\right)_{a,b}$ then f is being treated as a function of y , a , and b .

E.3 Integrals

Let f be a function of the variable x . Imagine the range of x between the limits x' and x'' to be divided into many small increments of size Δx_i ($i = 1, 2, \dots$). Let f_i be the value of f when x is in the middle of the range of the i th increment. Then the **integral**

$$\int_{x'}^{x''} f \, dx$$

is the sum $\sum_i f_i \Delta x_i$ in the limit as each Δx_i approaches zero and the number of terms in the sum approaches infinity. The integral is also the area under a curve of f plotted as a function of x , measured from $x = x'$ to $x = x''$. The function f is the **integrand**, which is integrated over the integration variable x .

This book uses the following integrals:

$$\int_{x'}^{x''} dx = x'' - x'$$

$$\int_{x'}^{x''} \frac{dx}{x} = \ln \left| \frac{x''}{x'} \right|$$

$$\int_{x'}^{x''} x^a dx = \frac{1}{a+1} [(x'')^{a+1} - (x')^{a+1}] \quad (a \text{ is a constant other than } -1)$$

$$\int_{x'}^{x''} \frac{dx}{ax+b} = \frac{1}{a} \ln \left| \frac{ax''+b}{ax'+b} \right| \quad (a \text{ is a constant})$$

Here are examples of the use of the expression for the third integral with a set equal to 1 and to -2 :

$$\int_{x'}^{x''} x \, dx = \frac{1}{2} [(x'')^2 - (x')^2]$$

$$\int_{x'}^{x''} \frac{dx}{x^2} = -\left(\frac{1}{x''} - \frac{1}{x'} \right)$$

E.4 Line Integrals

A **line integral** is an integral with an implicit single integration variable that constraints the integration to a path.

The most frequently-seen line integral in this book, $\int p \, dV$, will serve as an example. The integral can be evaluated in three different ways:

1. The integrand p can be expressed as a function of the integration variable V , so that there is only one variable. For example, if p equals c/V where c is a constant, the line integral is given by $\int p \, dV = c \int_{V_1}^{V_2} (1/V) \, dV = c \ln(V_2/V_1)$.
2. If p and V can be written as functions of another variable, such as time, that coordinates their values so that they follow the desired path, this new variable becomes the integration variable.
3. The desired path can be drawn as a curve on a plot of p versus V ; then $\int p \, dV$ is equal in value to the area under the curve.

MATHEMATICAL PROPERTIES OF STATE FUNCTIONS

A state function is a property of a thermodynamic system whose value at any given instant depends only on the state of the system at that instant (Sec. 2.4).

F.1 Differentials

The **differential** df of a state function f is an infinitesimal change of f . Since the value of a state function by definition depends only on the state of the system, integrating df between an initial state 1 and a final state 2 yields the change in f , and this change is independent of the path:

$$\int_{f_1}^{f_2} df = f_2 - f_1 = \Delta f \quad (\text{F.1.1})$$

A differential with this property is called an *exact* differential. The differential of a state function is always exact.

F.2 Total Differential

A state function f treated as a dependent variable is a function of a certain number of independent variables that are also state functions. The **total differential** of f is df expressed in terms of the differentials of the independent variables and has the form

$$df = \left(\frac{\partial f}{\partial x}\right) dx + \left(\frac{\partial f}{\partial y}\right) dy + \left(\frac{\partial f}{\partial z}\right) dz + \dots \quad (\text{F.2.1})$$

There are as many terms in the expression on the right side as there are independent variables. Each partial derivative in the expression has all independent variables held constant except the variable shown in the denominator.

Figure F.1 on the next page interprets this expression for a function f of the two independent variables x and y . The shaded plane represents a small element of the surface $f = f(x, y)$.

Consider a system with three independent variables. If we choose these independent variables to be x , y , and z , the total differential of the dependent state function f takes the

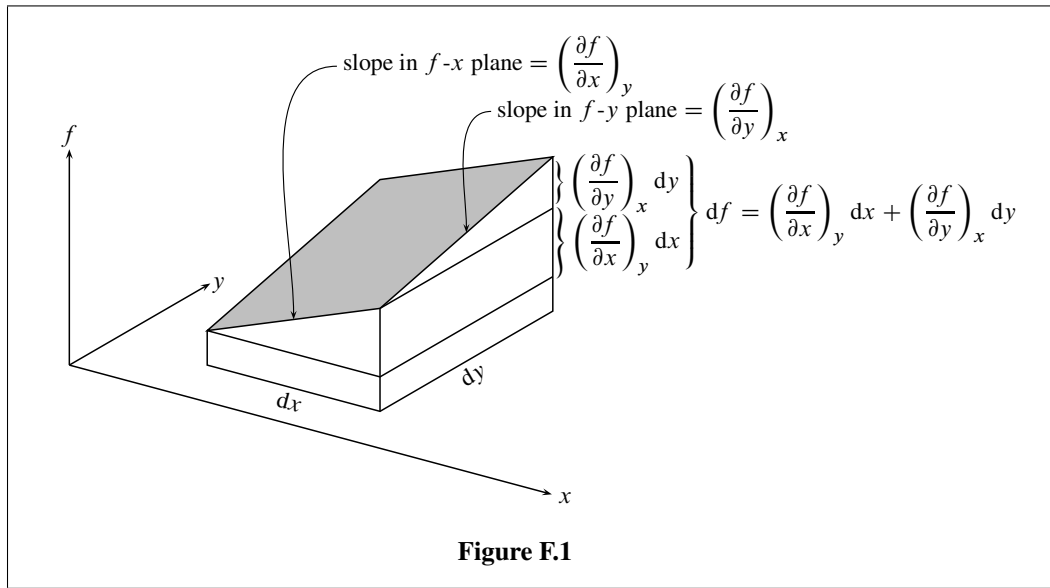

form

$$df = a dx + b dy + c dz \quad (\text{F.2.2})$$

where we can identify the coefficients as

$$a = \left(\frac{\partial f}{\partial x}\right)_{y,z} \quad b = \left(\frac{\partial f}{\partial y}\right)_{x,z} \quad c = \left(\frac{\partial f}{\partial z}\right)_{x,y} \quad (\text{F.2.3})$$

These coefficients are themselves, in general, functions of the independent variables and may be differentiated to give mixed second partial derivatives; for example:

$$\left(\frac{\partial a}{\partial y}\right)_{x,z} = \frac{\partial^2 f}{\partial y \partial x} \quad \left(\frac{\partial b}{\partial x}\right)_{y,z} = \frac{\partial^2 f}{\partial x \partial y} \quad (\text{F.2.4})$$

The second partial derivative $\partial^2 f / \partial y \partial x$, for instance, is the partial derivative with respect to y of the partial derivative of f with respect to x . It is a theorem of calculus that if a function f is single valued and has continuous derivatives, the order of differentiation in a mixed derivative is immaterial. Therefore the mixed derivatives $\partial^2 f / \partial y \partial x$ and $\partial^2 f / \partial x \partial y$, evaluated for the system in any given state, are equal:

$$\left(\frac{\partial a}{\partial y}\right)_{x,z} = \left(\frac{\partial b}{\partial x}\right)_{y,z} \quad (\text{F.2.5})$$

The general relation that applies to a function of any number of independent variables is

$$\left(\frac{\partial X}{\partial y}\right) = \left(\frac{\partial Y}{\partial x}\right) \quad (\text{F.2.6})$$

where x and y are *any* two of the independent variables, X is $\partial f / \partial x$, Y is $\partial f / \partial y$, and each partial derivative has all independent variables held constant except the variable shown in the denominator. This general relation is the Euler reciprocity relation, or **reciprocity relation** for short. A necessary and sufficient condition for df to be an exact differential is that the reciprocity relation is satisfied for each pair of independent variables.

F.3 Integration of a Total Differential

If the coefficients of the total differential of a dependent variable are known as functions of the independent variables, the expression for the total differential may be integrated to obtain an expression for the dependent variable as a function of the independent variables.

For example, suppose the total differential of the state function $f(x, y, z)$ is given by Eq. F.2.2 and the coefficients are known functions $a(x, y, z)$, $b(x, y, z)$, and $c(x, y, z)$. Because f is a state function, its change between $f(0, 0, 0)$ and $f(x', y', z')$ is independent of the integration path taken between these two states. A convenient path would be one with the following three segments:

1. integration from $(0, 0, 0)$ to $(x', 0, 0)$: $\int_0^{x'} a(x, 0, 0) dx$
2. integration from $(x', 0, 0)$ to $(x', y', 0)$: $\int_0^{y'} b(x', y, 0) dy$
3. integration from $(x', y', 0)$ to (x', y', z') : $\int_0^{z'} c(x', y', z) dz$

The expression for $f(x, y, z)$ is then the sum of the three integrals and a constant of integration.

Here is an example of this procedure applied to the total differential

$$df = (2xy) dx + (x^2 + z) dy + (y - 9z^2) dz \quad (\text{F.3.1})$$

An expression for the function f in this example is given by the sum

$$\begin{aligned} f &= \int_0^{x'} (2x \cdot 0) dx + \int_0^{y'} [(x')^2 + 0] dy + \int_0^{z'} (y' - 9z^2) dz + C \\ &= 0 + x'^2 y + (yz - 9z^3/3) + C \\ &= x^2 y + yz - 3z^3 + C \end{aligned} \quad (\text{F.3.2})$$

where primes are omitted on the second and third lines because the expressions are supposed to apply to any values of x , y , and z . C is an integration constant. You can verify that the third line of Eq. F.3.2 gives the correct expression for f by taking partial derivatives with respect to x , y , and z and comparing with Eq. F.3.1.

In chemical thermodynamics, there is not likely to be occasion to perform this kind of integration. The fact that it can be done, however, shows that if we stick to one set of independent variables, the expression for the total differential of an independent variable contains the same information as the independent variable itself.

A different kind of integration can be used to express a dependent extensive property in terms of independent extensive properties. An *extensive* property of a thermodynamic system is one that is additive, and an *intensive* property is one that is not additive and has the same value everywhere in a homogeneous region (Sec. 2.1.1). Suppose we have a state function f that is an extensive property with the total differential

$$df = a dx + b dy + c dz + \dots \quad (\text{F.3.3})$$

where the independent variables x, y, z, \dots are extensive and the coefficients a, b, c, \dots are intensive. If the independent variables include those needed to describe an open system (for example, the amounts of the substances), then it is possible to integrate both sides of

the equation from a lower limit of zero for each of the extensive functions while holding the intensive functions constant:

$$\int_0^{f'} df = a \int_0^{x'} dx + b \int_0^{y'} dy + c \int_0^{z'} dz + \dots \quad (\text{F.3.4})$$

$$f' = ax' + by' + cz' + \dots \quad (\text{F.3.5})$$

Note that a term of the form $c du$ where u is *intensive* becomes *zero* when integrated with intensive functions held constant, because du in this case is zero.

F.4 Legendre Transforms

A **Legendre transform** of a state function is a linear change of one or more of the independent variables made by subtracting products of conjugate variables.

To understand how this works, consider a state function f whose total differential is given by

$$df = a dx + b dy + c dz \quad (\text{F.4.1})$$

In the expression on the right side, x , y , and z are being treated as the independent variables. The pairs a and x , b and y , and c and z are *conjugate pairs*. That is, a and x are conjugates, b and y are conjugates, and c and z are conjugates.

For the first example of a Legendre transform, we define a new state function f_1 by subtracting the product of the conjugate variables a and x :

$$f_1 \stackrel{\text{def}}{=} f - ax \quad (\text{F.4.2})$$

The function f_1 is a Legendre transform of f . We take the differential of Eq. F.4.2

$$df_1 = df - a dx - x da \quad (\text{F.4.3})$$

and substitute for df from Eq. F.4.1:

$$\begin{aligned} df_1 &= (a dx + b dy + c dz) - a dx - x da \\ &= -x da + b dy + c dz \end{aligned} \quad (\text{F.4.4})$$

Equation F.4.4 gives the total differential of f_1 with a , y , and z as the independent variables. The functions x and a have switched places as independent variables. What we did in order to let a replace x as an independent variable was to subtract from f the product of the conjugate variables a and x .

Because the right side of Eq. F.4.4 is an expression for the total differential of the state function f_1 , we can use the expression to identify the coefficients as partial derivatives of f_1 with respect to the new set of independent variables:

$$-x = \left(\frac{\partial f_1}{\partial a} \right)_{y,z} \quad b = \left(\frac{\partial f_1}{\partial y} \right)_{a,z} \quad c = \left(\frac{\partial f_1}{\partial z} \right)_{a,y} \quad (\text{F.4.5})$$

We can also use Eq. F.4.4 to write new reciprocity relations, such as

$$-\left(\frac{\partial x}{\partial y} \right)_{a,z} = \left(\frac{\partial b}{\partial a} \right)_{y,z} \quad (\text{F.4.6})$$

We can make other Legendre transforms of f by subtracting one or more products of conjugate variables. A second example of a Legendre transform is

$$f_2 \stackrel{\text{def}}{=} f - by - cz \quad (\text{F.4.7})$$

whose total differential is

$$\begin{aligned} df_2 &= df - b dy - y db - c dz - z dc \\ &= a dx - y db - z dc \end{aligned} \quad (\text{F.4.8})$$

Here b has replaced y and c has replaced z as independent variables. Again, we can identify the coefficients as partial derivatives and write new reciprocity relations.

If we have an algebraic expression for a state function as a function of independent variables, then a Legendre transform preserves all the information contained in that expression. To illustrate this, we can use the state function f and its Legendre transform f_2 described above. Suppose we have an expression for $f(x, y, z)$ —this is f expressed as a function of the independent variables x , y , and z . Then by taking partial derivatives of this expression, we can find according to Eq. F.2.3 expressions for the functions $a(x, y, z)$, $b(x, y, z)$, and $c(x, y, z)$.

Now we perform the Legendre transform of Eq. F.4.7: $f_2 = f - by - cz$ with total differential $df_2 = a dx - y db - z dc$ (Eq. F.4.8). The independent variables have been changed from x , y , and z to x , b , and c .

We want to find an expression for f_2 as a function of these new variables, using the information available from the original function $f(x, y, z)$. To do this, we eliminate z from the known functions $b(x, y, z)$ and $c(x, y, z)$ and solve for y as a function of x , b , and c . We also eliminate y from $b(x, y, z)$ and $c(x, y, z)$ and solve for z as a function of x , b , and c . This gives us expressions for $y(x, b, c)$ and $z(x, b, c)$ which we substitute into the expression for $f(x, y, z)$, turning it into the function $f(x, b, c)$. Finally, we use the functions of the new variables to obtain an expression for $f_2(x, b, c) = f(x, b, c) - by(x, b, c) - cz(x, b, c)$.

The original expression for $f(x, y, z)$ and the new expression for $f_2(x, b, c)$ contain the same information. We could take the expression for $f_2(x, b, c)$ and, by following the same procedure with the Legendre transform $f = f_2 + by + cz$, retrieve the expression for $f(x, y, z)$. Thus no information is lost during a Legendre transform.

APPENDIX G

FORCES, ENERGY, AND WORK

The aim of this appendix is to describe a simple model that will help to clarify the meaning of energy and mechanical work in macroscopic systems. The appendix applies fundamental principles of classical mechanics to a collection of material particles representing a closed system and its surroundings. Although classical mechanics cannot duplicate all features of a chemical system—for instance, quantum properties of atoms are ignored—the behavior of the particles and their interactions will show us how to evaluate the thermodynamic work in a real system.

In broad outline the derivation is as follows. An inertial reference frame in which Newton's laws of motion are valid is used to describe the positions and velocities of the particles. The particles are assumed to exert central forces on one another, such that between any two particles the force is a function only of the interparticle distance and is directed along the line between the particles.

We define the kinetic energy of the collection of particles as the sum for all particles of $\frac{1}{2}mv^2$ (where m is mass and v is velocity). We define the potential energy as the sum over pairwise particle–particle interactions of potential functions that depend only on the interparticle distances. The total energy is the sum of the kinetic and potential energies. With these definitions and Newton's laws, a series of mathematical operations leads to the principle of the conservation of energy: the total energy remains constant over time.

Continuing the derivation, we consider one group of particles to represent a closed thermodynamic system and the remaining particles to constitute the surroundings. The system particles may interact with an external force field, such as a gravitational field, created by some of the particles in the surroundings. The energy of the system is considered to be the sum of the kinetic energy of the system particles, the potential energy of pairwise particle–particle interactions within the system, and the potential energy of the system particles in any external field or fields. The change in the system energy during a time interval is then found to be given by a certain sum of integrals which, in the transition to a macroscopic model, becomes the sum of heat and thermodynamic work in accord with the first law of thermodynamics.

A similar derivation, using a slightly different notation, is given in Ref. [45].

G.1 Forces between Particles

A *material particle* is a body that has mass and is so small that it behaves as a point, without rotational energy or internal structure. We assume each particle has a constant mass, ignoring relativistic effects that are important only when the particle moves at a speed close to the speed of light.

Consider a collection of an arbitrary number of material particles that have interactions only among themselves and with no other particles. Later we will consider some of the particles to constitute a thermodynamic *system* and the others to be the *surroundings*.

Newton's laws of motion are obeyed only in an *inertial* reference frame. A reference frame that is fixed or moving at a constant velocity relative to local stars is practically an inertial reference frame. To a good approximation, a reference frame fixed relative to the earth's surface is also an inertial system (the necessary corrections are discussed in Sec. G.10). This reference frame will be called simply the *lab frame*, and treated as an inertial frame in order that we may apply Newton's laws.

It will be assumed that the Cartesian components of all vector quantities appearing in Sections G.1–G.4 are measured in an inertial lab frame.

Classical mechanics is based on the idea that one material particle acts on another by means of a *force* that is independent of the reference frame. Let the vector \mathbf{F}_{ij} denote the force exerted on particle i by particle j .¹ The *net* force \mathbf{F}_i acting on particle i is the vector sum of the individual forces exerted on it by the other particles:²

$$\mathbf{F}_i = \sum_{j \neq i} \mathbf{F}_{ij} \quad (\text{G.1.1})$$

(The term in which j equals i has to be omitted because a particle does not act on itself.) According to Newton's second law of motion, the net force \mathbf{F}_i acting on particle i is equal to the product of its mass m_i and its acceleration:

$$\mathbf{F}_i = m_i \frac{d\mathbf{v}_i}{dt} \quad (\text{G.1.2})$$

Here \mathbf{v}_i is the particle's velocity in the lab frame and t is time.

A nonzero net force causes particle i to accelerate and its velocity and position to change. The *work* done by the net force acting on the particle in a given time interval is defined by the integral³

$$W_i = \int \mathbf{F}_i \cdot d\mathbf{r}_i \quad (\text{G.1.3})$$

where \mathbf{r}_i is the position vector of the particle—a vector from the origin of the lab frame to the position of the particle.

¹This and the next two footnotes are included for readers who are not familiar with vector notation. The quantity \mathbf{F}_{ij} is printed in boldface to indicate it is a *vector* having both magnitude and direction.

²The rule for adding vectors, as in the summation shown here, is that the sum is a vector whose component along each axis of a Cartesian coordinate system is the sum of the components along that axis of the vectors being added. For example, the vector $\mathbf{C} = \mathbf{A} + \mathbf{B}$ has components $C_x = A_x + B_x$, $C_y = A_y + B_y$, and $C_z = A_z + B_z$.

³The dot between the vectors in the integrand indicates a scalar product or dot product, which is a *nonvector* quantity. The general definition of the scalar product of two vectors, \mathbf{A} and \mathbf{B} , is $\mathbf{A} \cdot \mathbf{B} = AB \cos \alpha$ where A and B are the magnitudes of the two vectors and α is the angle between their positive directions.

The integral on the right side of Eq. G.1.3 is an example of a *line integral*. It indicates that the scalar product of the net force acting on the particle and the particle's displacement is to be integrated over time during the time interval. The integral can be written without vectors in the form $\int F_i \cos \alpha (ds/dt) dt$ where F_i is the magnitude of the net force, ds/dt is the magnitude of the velocity of the particle along its path in three-dimensional space, and α is the angle between the force and velocity vectors. The three quantities F_i , $\cos \alpha$, and ds/dt are all functions of time, t , and the integration is carried out with time as the integration variable.

By substituting the expression for \mathbf{F}_i (Eq. G.1.2) in Eq. G.1.3, we obtain

$$\begin{aligned} W_i &= m_i \int \frac{d\mathbf{v}_i}{dt} \cdot d\mathbf{r}_i = m_i \int \frac{d\mathbf{r}_i}{dt} \cdot d\mathbf{v}_i = m_i \int \mathbf{v}_i \cdot d\mathbf{v}_i = m_i \int v_i dv_i \\ &= \Delta\left(\frac{1}{2}m_i v_i^2\right) \end{aligned} \quad (\text{G.1.4})$$

where v_i is the magnitude of the velocity.

The quantity $\frac{1}{2}m_i v_i^2$ is called the *kinetic energy* of particle i . This kinetic energy depends only on the magnitude of the velocity (i.e., on the speed) and not on the particle's position.

The *total work* W_{tot} done by all forces acting on all particles during the time interval is the sum of W_i for all particles: $W_{\text{tot}} = \sum_i W_i$.⁴ Equation G.1.4 then gives us

$$W_{\text{tot}} = \sum_i \Delta\left(\frac{1}{2}m_i v_i^2\right) = \Delta\left(\sum_i \frac{1}{2}m_i v_i^2\right) \quad (\text{G.1.5})$$

Equation G.1.5 shows that the total work during a time interval is equal to the change in the total kinetic energy in this interval. This result is called the “work-energy principle” by physicists.⁵

From Eqs. G.1.1 and G.1.3 we obtain a second expression for W_{tot} :

$$W_{\text{tot}} = \sum_i W_i = \sum_i \int \sum_{j \neq i} \mathbf{F}_{ij} \cdot d\mathbf{r}_i = \sum_i \sum_{j \neq i} \int \mathbf{F}_{ij} \cdot d\mathbf{r}_i \quad (\text{G.1.6})$$

The double sum in the right-most expression can be written as a sum over pairs of particles, the term for the pair i and j being

$$\begin{aligned} \int \mathbf{F}_{ij} \cdot d\mathbf{r}_i + \int \mathbf{F}_{ji} \cdot d\mathbf{r}_j &= \int \mathbf{F}_{ij} \cdot d\mathbf{r}_i - \int \mathbf{F}_{ij} \cdot d\mathbf{r}_j \\ &= \int \mathbf{F}_{ij} \cdot d(\mathbf{r}_i - \mathbf{r}_j) = \int (\mathbf{F}_{ij} \cdot \mathbf{e}_{ij}) dr_{ij} \end{aligned} \quad (\text{G.1.7})$$

Here we have used the relations $\mathbf{F}_{ji} = -\mathbf{F}_{ij}$ (from Newton's third law) and $(\mathbf{r}_i - \mathbf{r}_j) = \mathbf{e}_{ij}r_{ij}$, where \mathbf{e}_{ij} is a unit vector pointing from j to i and r_{ij} is the distance between the particles. Equation G.1.6 becomes

$$W_{\text{tot}} = \sum_i \sum_{j \neq i} \int \mathbf{F}_{ij} \cdot d\mathbf{r}_i = \sum_i \sum_{j > i} \int (\mathbf{F}_{ij} \cdot \mathbf{e}_{ij}) dr_{ij} \quad (\text{G.1.8})$$

⁴The work W_{tot} defined here is not the same as the thermodynamic work appearing in the first law of thermodynamics.

⁵Ref. [161], p. 95.

Next we look in detail at the force that particle j exerts on particle i . This force depends on the nature of the two particles and on the distance between them. For instance, Newton's law of universal gravitation gives the magnitude of a *gravitational* force as $Gm_i m_j / r_{ij}^2$, where G is the gravitational constant. Coulomb's law gives the magnitude of an *electrical* force between stationary charged particles as $Q_i Q_j / (4\pi\epsilon_0 r_{ij}^2)$, where Q_i and Q_j are the charges and ϵ_0 is the electric constant (or permittivity of vacuum). These two kinds of forces are central forces that obey Newton's third law of action and reaction, namely, that the forces exerted by two particles on one another are equal in magnitude and opposite in direction and are directed along the line joining the two particles. (In contrast, the *electromagnetic* force between charged particles in relative motion does *not* obey Newton's third law.)

We will assume the force \mathbf{F}_{ij} exerted on particle i by particle j has a magnitude that depends only on the interparticle distance r_{ij} and is directed along the line between i and j , as is true of gravitational and electrostatic forces and on intermolecular forces in general. Then we can define a *potential function*, Φ_{ij} , for this force that will be a contribution to the potential energy. To see how Φ_{ij} is related to \mathbf{F}_{ij} , we look at Eq. G.1.7. The left-most expression, $\int \mathbf{F}_{ij} \cdot d\mathbf{r}_i + \int \mathbf{F}_{ji} \cdot d\mathbf{r}_j$, is the change in the kinetic energies of particles i and j during a time interval (see Eq. G.1.4). If these were the only particles, their total energy should be constant for conservation of energy; thus $\Delta\Phi_{ij}$ should have the same magnitude and the opposite sign of the kinetic energy change:

$$\Delta\Phi_{ij} = - \int (\mathbf{F}_{ij} \cdot \mathbf{e}_{ij}) dr_{ij} \quad (\text{G.1.9})$$

The value of Φ_{ij} at any interparticle distance r_{ij} is fully defined by Eq. G.1.9 and the choice of an arbitrary zero. The quantity $(\mathbf{F}_{ij} \cdot \mathbf{e}_{ij})$ is simply the component of the force along the line between the particles, and is negative for an attractive force (one in which \mathbf{F}_{ij} points from i to j) and positive for a repulsive force. If the force is attractive, the value of Φ_{ij} increases with increasing r_{ij} ; if the force is repulsive, Φ_{ij} decreases with increasing r_{ij} . Since Φ_{ij} is a function only of r_{ij} , it is independent of the choice of reference frame.

Equations G.1.8 and G.1.9 can be combined to give

$$W_{\text{tot}} = - \sum_i \sum_{j>i} \Delta\Phi_{ij} = -\Delta \left(\sum_i \sum_{j>i} \Phi_{ij} \right) \quad (\text{G.1.10})$$

By equating the expressions for W_{tot} given by Eqs. G.1.5 and G.1.10 and rearranging, we obtain

$$\Delta \left(\sum_i \frac{1}{2} m_i v_i^2 \right) + \Delta \left(\sum_i \sum_{j>i} \Phi_{ij} \right) = 0 \quad (\text{G.1.11})$$

This equation shows that the quantity

$$E_{\text{tot}} = \sum_i \frac{1}{2} m_i v_i^2 + \sum_i \sum_{j>i} \Phi_{ij} \quad (\text{G.1.12})$$

is constant over time as the particles move in response to the forces acting on them. The first term on the right side of Eq. G.1.12 is the total kinetic energy of the particles. The second term is the pairwise sum of particle–particle potential functions; this term is called

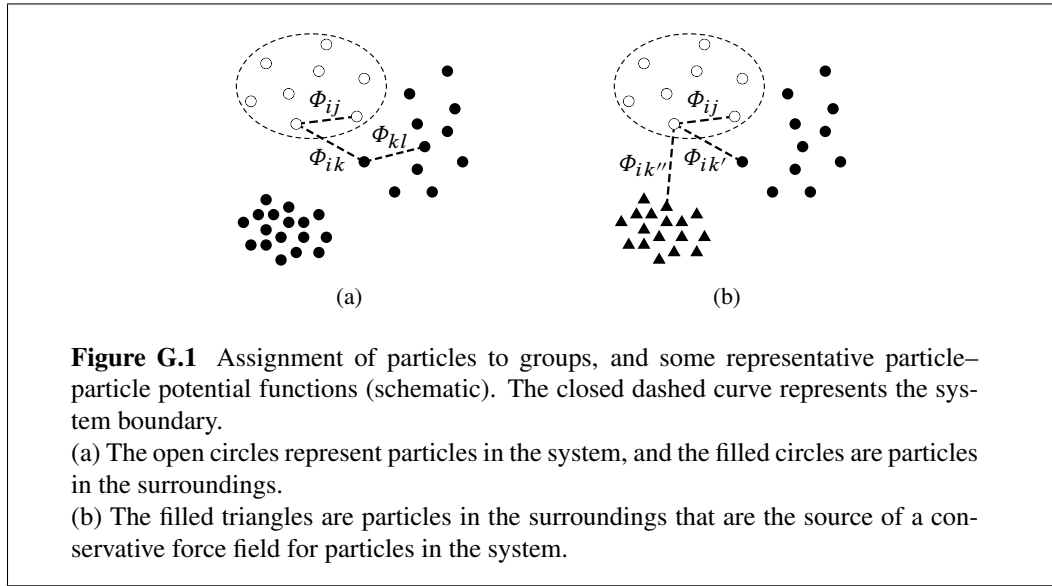

the *potential energy* of the particles. Note that the kinetic energy depends only on particle speeds and the potential energy depends only on particle positions.

The significance of Eq. G.1.11 is that the total energy E_{tot} defined by Eq. G.1.12 is *conserved*. This will be true provided the reference frame used for kinetic energy is inertial and the only forces acting on the particles are those responsible for the particle–particle potential functions.

G.2 The System and Surroundings

Now we are ready to assign the particles to two groups: particles in the system and those in the surroundings. This section will use the following convention: indices i and j refer to particles in the *system*; indices k and l refer to particles in the *surroundings*. This division of particles is illustrated schematically in Fig. G.1(a). With this change in notation, Eq. G.1.12 becomes

$$E_{\text{tot}} = \sum_i \frac{1}{2} m_i v_i^2 + \sum_i \sum_{j>i} \Phi_{ij} + \sum_i \sum_k \Phi_{ik} + \sum_k \frac{1}{2} m_k v_k^2 + \sum_k \sum_{l>k} \Phi_{kl} \quad (\text{G.2.1})$$

A portion of the surroundings may create a time-independent conservative force field (an “external” field) for a particle in the system. In order for such a field to be present, its contribution to the force exerted on the particle and to the particle’s potential energy must depend only on the particle’s position in the lab frame. The usual gravitational and electrostatic fields are of this type.

In order to clarify the properties of a conservative external field, the index k' will be used for those particles in the surroundings that are not the source of an external field, and k'' for those that are, as indicated in Fig. G.1(b). Then the force exerted on system particle i due to the field is $\mathbf{F}_i^{\text{field}} = \sum_{k''} \mathbf{F}_{ik''}$. If this were the only force acting on particle i , the change in its kinetic energy during a time interval would be $\int \mathbf{F}_i^{\text{field}} \cdot d\mathbf{r}_i$ (Eq. G.1.4). For conservation of energy, the potential energy change in the time interval should have the

same magnitude and the opposite sign:

$$\Delta\Phi_i^{\text{field}} = - \int \mathbf{F}_i^{\text{field}} \cdot d\mathbf{r}_i \quad (\text{G.2.2})$$

Only if the integral $\int \mathbf{F}_i^{\text{field}} \cdot d\mathbf{r}_i$ has the same value for all paths between the initial and final positions of the particle does a conservative force field exist; otherwise the concept of a potential energy Φ_i^{field} is not valid.

Taking a gravitational field as an example of a conservative external field, we replace $\mathbf{F}_i^{\text{field}}$ and Φ_i^{field} by $\mathbf{F}_i^{\text{grav}}$ and Φ_i^{grav} : $\Delta\Phi_i^{\text{grav}} = - \int \mathbf{F}_i^{\text{grav}} \cdot d\mathbf{r}_i$. The gravitational force on particle i is, from Newton's second law, the product of the particle mass and its acceleration $-g\mathbf{e}_z$ in the gravitational field: $\mathbf{F}_i^{\text{grav}} = -m_i g \mathbf{e}_z$ where g is the acceleration of free fall and \mathbf{e}_z is a unit vector in the vertical (upward) z direction. The change in the gravitational potential energy given by Eq. G.2.2 is

$$\Delta\Phi_i^{\text{grav}} = m_i g \int \mathbf{e}_z \cdot d\mathbf{r}_i = m_i g \Delta z_i \quad (\text{G.2.3})$$

(The range of elevations of the system particles is assumed to be small compared with the earth's radius, so that each system particle experiences essentially the same constant value of g .) Thus we can define the gravitational potential energy of particle i , which is a function only of the particle's vertical position in the lab frame, by $\Phi_i^{\text{grav}} = m_i g z_i + C_i$ where C_i is an arbitrary constant.

Returning to Eq. G.2.1 for the total energy, we can now write the third term on the right side in the form

$$\sum_i \sum_k \Phi_{ik} = \sum_i \sum_{k'} \Phi_{ik'} + \sum_i \Phi_i^{\text{field}} \quad (\text{G.2.4})$$

To divide the expression for the total energy into meaningful parts, we substitute Eq. G.2.4 in Eq. G.2.1 and rearrange in the form

$$E_{\text{tot}} = \left[\sum_i \frac{1}{2} m_i v_i^2 + \sum_i \sum_{j>i} \Phi_{ij} + \sum_i \Phi_i^{\text{field}} \right] + \left[\sum_i \sum_{k'} \Phi_{ik'} \right] + \left[\sum_k \frac{1}{2} m_k v_k^2 + \sum_k \sum_{l>k} \Phi_{kl} \right] \quad (\text{G.2.5})$$

The terms on the right side of this equation are shown grouped with brackets into three quantities. The first quantity depends only on the speeds and positions of the particles in the *system*, and thus represents the energy of the system:

$$E_{\text{sys}} = \sum_i \frac{1}{2} m_i v_i^2 + \sum_i \sum_{j>i} \Phi_{ij} + \sum_i \Phi_i^{\text{field}} \quad (\text{G.2.6})$$

The three terms in this expression for E_{sys} are, respectively, the kinetic energy of the system particles relative to the lab frame, the potential energy of interaction among the system particles, and the total potential energy of the system in the external field.

The last bracketed quantity on the right side of Eq. G.2.5 depends only on the speeds and positions of all the particles in the *surroundings*, so that this quantity is the energy of the surroundings, E_{surr} . Thus, an abbreviated form of Eq. G.2.5 is

$$E_{\text{tot}} = E_{\text{sys}} + \sum_i \sum_{k'} \Phi_{ik'} + E_{\text{surr}} \quad (\text{G.2.7})$$

The quantity $\sum_i \sum_{k'} \Phi_{ik'}$ represents potential energy shared by both the system and surroundings on account of forces acting across the system boundary, other than gravitational forces or forces from other external fields. The forces responsible for the quantity $\sum_i \sum_{k'} \Phi_{ik'}$ are generally significant only between particles in the immediate vicinity of the system boundary, and will presently turn out to be the crucial forces for evaluating thermodynamic work.

G.3 System Energy Change

This section derives an important relation between the change ΔE_{sys} of the energy of the system measured in a lab frame, and the forces exerted by the surroundings on the system particles. The indices i and j will refer to only the particles in the *system*.

We write the net force on particle i in the form

$$\mathbf{F}_i = \sum_{j \neq i} \mathbf{F}_{ij} + \mathbf{F}_i^{\text{field}} + \mathbf{F}_i^{\text{sur}} \quad (\text{G.3.1})$$

where \mathbf{F}_{ij} is the force exerted on particle i by particle j , both particles being in the system, and $\mathbf{F}_i^{\text{sur}} = \sum_{k'} \mathbf{F}_{ik'}$ is the net force exerted on particle i by the particles in the surroundings that are not the source of an external field. During a given period of time, the work done by forces acting on only the system particles is

$$\sum_i \int \mathbf{F}_i \cdot d\mathbf{r}_i = \sum_i \sum_{j \neq i} \int \mathbf{F}_{ij} \cdot d\mathbf{r}_i + \sum_i \int \mathbf{F}_i^{\text{field}} \cdot d\mathbf{r}_i + \sum_i \int \mathbf{F}_i^{\text{sur}} \cdot d\mathbf{r}_i \quad (\text{G.3.2})$$

We can replace the first three sums in this equation with new expressions. Using Eq. G.1.4, we have

$$\sum_i \int \mathbf{F}_i \cdot d\mathbf{r}_i = \Delta \left(\sum_i \frac{1}{2} m_i v_i^2 \right) \quad (\text{G.3.3})$$

From Eqs. G.1.8 and G.1.9 we obtain

$$\sum_i \sum_{j \neq i} \int \mathbf{F}_{ij} \cdot d\mathbf{r}_i = -\Delta \left(\sum_i \sum_{j > i} \Phi_{ij} \right) \quad (\text{G.3.4})$$

where the sums are over the system particles. From Eq. G.2.2 we can write

$$\sum_i \int \mathbf{F}_i^{\text{field}} \cdot d\mathbf{r}_i = -\Delta \left(\sum_i \Phi_i^{\text{field}} \right) \quad (\text{G.3.5})$$

Combining Eqs. G.3.2–G.3.5 and rearranging, we obtain

$$\sum_i \int \mathbf{F}_i^{\text{sur}} \cdot d\mathbf{r}_i = \Delta \left(\sum_i \frac{1}{2} m_i v_i^2 + \sum_i \sum_{j > i} \Phi_{ij} + \sum_i \Phi_i^{\text{field}} \right) \quad (\text{G.3.6})$$

Comparison of the expression on the right side of this equation with Eq. G.2.6 shows that the expression is the same as the change of E_{sys} :

$$\Delta E_{\text{sys}} = \sum_i \int \mathbf{F}_i^{\text{sur}} \cdot d\mathbf{r}_i \quad (\text{G.3.7})$$

Recall that the vector $\mathbf{F}_i^{\text{sur}}$ is the force exerted on particle i , in the system, by the particles in the surroundings other than those responsible for an external field. Thus ΔE_{sys} is equal to the total work done on the system by the surroundings, other than work done by an external field such as a gravitational field.

It might seem strange that work done by an external field is not included in ΔE_{sys} . The reason it is not included is that Φ_i^{field} was defined to be a potential energy belonging only to the system, and is thus irrelevant to energy transfer from or to the surroundings.

As a simple example of how this works, consider a system consisting of a solid body in a gravitational field. If the only force exerted on the body is the downward gravitational force, then the body is in free fall but ΔE_{sys} in the lab frame is zero; the loss of gravitational potential energy as the body falls is equal to the gain of kinetic energy. On the other hand, work done on the system by an external force that *opposes* the gravitational force is included in ΔE_{sys} . For example, if the body is pulled upwards at a constant speed with a string, its potential energy increases while its kinetic energy remains constant, and E_{sys} increases.

G.4 Macroscopic Work

In thermodynamics we are interested in the quantity of work done on *macroscopic* parts of the system during a process, rather than the work done on individual particles. Macroscopic work is the energy transferred across the system boundary due to concerted motion of many particles on which the surroundings exert a force. Macroscopic *mechanical* work occurs when there is displacement of a macroscopic portion of the system on which a short-range *contact force* acts across the system boundary. This force could be, for instance, the pressure of an external fluid at a surface element of the boundary multiplied by the area of the surface element, or it could be the tension in a cord at the point where the cord passes through the boundary.

The symbol w_{lab} will refer to macroscopic work measured with displacements in the lab frame.

At any given instant, only the system particles that are close to the boundary will have nonnegligible contact forces exerted on them. We can define an *interaction layer*, a thin shell-like layer within the system and next to the system boundary that contains all the system particles with appreciable contact forces. We imagine the interaction layer to be divided into volume elements, or segments, each of which either moves as a whole during the process or else is stationary. Let \mathbf{R}_τ be a position vector from the origin of the lab frame to a point fixed in the boundary at segment τ , and let $\mathbf{r}_{i\tau}$ be a vector from this point to particle i (Fig. G.2). Then the position vector for particle i can be written $\mathbf{r}_i = \mathbf{R}_\tau + \mathbf{r}_{i\tau}$. Let $\mathbf{F}_\tau^{\text{sur}}$ be the total contact force exerted by the surroundings on the system particles in segment τ : $\mathbf{F}_\tau^{\text{sur}} = \sum_i \delta_{i\tau} \mathbf{F}_i^{\text{sur}}$, where $\delta_{i\tau}$ is equal to 1 when particle i is in segment τ and is zero otherwise.

The change in the system energy during a process is, from Eq. G.3.7,

$$\begin{aligned} \Delta E_{\text{sys}} &= \sum_i \int \mathbf{F}_i^{\text{sur}} \cdot d\mathbf{r}_i = \sum_\tau \sum_i \int \delta_{i\tau} \mathbf{F}_i^{\text{sur}} \cdot d(\mathbf{R}_\tau + \mathbf{r}_{i\tau}) \\ &= \sum_\tau \int \mathbf{F}_\tau^{\text{sur}} \cdot d\mathbf{R}_\tau + \sum_\tau \sum_i \int \delta_{i\tau} \mathbf{F}_i^{\text{sur}} \cdot d\mathbf{r}_{i\tau} \end{aligned} \quad (\text{G.4.1})$$

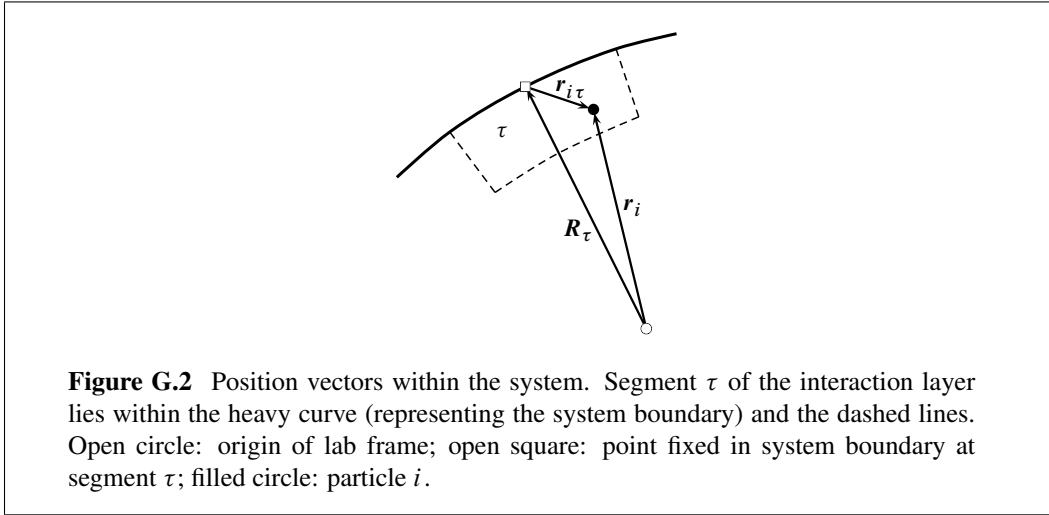

We recognize the integral $\int \mathbf{F}_\tau^{\text{sur}} \cdot d\mathbf{R}_\tau$ as the macroscopic work at surface element τ , because it is the integrated scalar product of the force exerted by the surroundings and the displacement. The total macroscopic work during the process is then given by

$$w_{\text{lab}} = \sum_{\tau} \int \mathbf{F}_\tau^{\text{sur}} \cdot d\mathbf{R}_\tau \quad (\text{G.4.2})$$

Heat, q_{lab} , can be defined as energy transfer to or from the system that is not accounted for by macroscopic work. This transfer occurs by means of chaotic motions and collisions of individual particles at the boundary. With this understanding, Eq. G.4.1 becomes

$$\Delta E_{\text{sys}} = q_{\text{lab}} + w_{\text{lab}} \quad (\text{G.4.3})$$

with w_{lab} given by the expression in Eq. G.4.2 and q_{lab} given by

$$q_{\text{lab}} = \sum_{\tau} \sum_i \int \delta_{i\tau} \mathbf{F}_i^{\text{sur}} \cdot d\mathbf{r}_{i\tau} \quad (\text{G.4.4})$$

G.5 The Work Done on the System and Surroundings

An additional comment can be made about the transfer of energy between the system and the surroundings. We may use Eq. G.4.2, with appropriate redefinition of the quantities on the right side, to evaluate the work done on the *surroundings*. This work may be equal in magnitude and opposite in sign to the work w_{lab} done on the system. A necessary condition for this equality is that the interacting parts of the system and surroundings have equal displacements; that is, that there be continuity of motion at the system boundary. We expect there to be continuity of motion when a fluid contacts a moving piston or paddle.

Suppose, however, that the system is stationary and an interacting part of the surroundings moves. Then according to Eq. G.4.2, w_{lab} is zero, whereas the work done on or by that part of the surroundings is *not* zero. How can this be, considering that E_{tot} remains constant? One possibility, discussed by Bridgman,⁶ is sliding friction at the boundary: energy

⁶Ref. [23], p. 47–56.

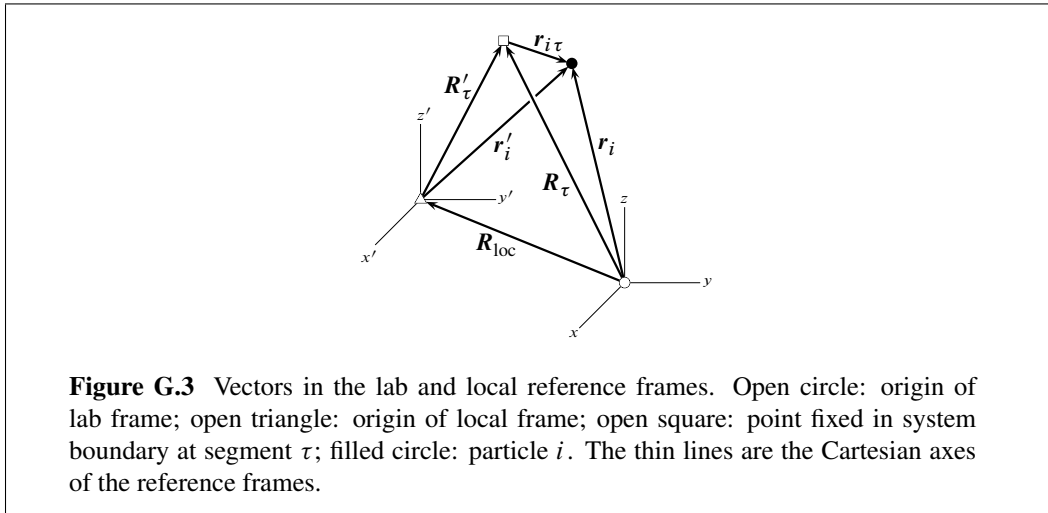

Figure G.3 Vectors in the lab and local reference frames. Open circle: origin of lab frame; open triangle: origin of local frame; open square: point fixed in system boundary at segment τ ; filled circle: particle i . The thin lines are the Cartesian axes of the reference frames.

lost by the surroundings in the form of work is gained by the system and surroundings in the form of thermal energy. Since the effect on the system is the same as a flow of heat from the surroundings, the division of energy transfer into heat and work can be ambiguous when there is sliding friction at the boundary.⁷

Another way work can have different magnitudes for system and surroundings is a change in potential energy shared by the system and surroundings. This shared energy is associated with forces acting across the boundary, other than from a time-independent external field, and is represented in Eq. G.2.7 by the sum $\sum_i \sum_{k'} \Phi_{ik'}$. In the usual types of processes this sum is either practically constant, or else each term falls off so rapidly with distance that the sum is negligible. Since E_{tot} is constant, during such processes the quantity $E_{\text{sys}} + E_{\text{surr}}$ remains essentially constant.

G.6 The Local Frame and Internal Energy

As explained in Sec. 2.6.2, a lab frame may not be an appropriate reference frame in which to measure changes in the system's energy. This is the case when the system as a whole moves or rotates in the lab frame, so that E_{sys} depends in part on external coordinates that are not state functions. In this case it may be possible to define a *local frame* moving with the system in which the energy of the system is a state function, the internal energy U .

As before, \mathbf{r}_i is the position vector of particle i in a lab frame. A prime notation will be used for quantities measured in the local frame. Thus the position of particle i relative to the local frame is given by vector \mathbf{r}'_i , which points from the origin of the local frame to particle i (see Fig. G.3). The velocity of the particle in the local frame is $\mathbf{v}'_i = d\mathbf{r}'_i/dt$.

We continue to treat the earth-fixed lab frame as an inertial frame, although this is not strictly true (Sec. G.10). If the origin of the local frame moves at constant velocity in the lab frame, with Cartesian axes that do not rotate with respect to those of the lab frame, then the

⁷The ambiguity can be removed by redefining the system boundary so that a thin stationary layer next to the sliding interface, on the side that was originally part of the system, is considered to be included in the surroundings instead of the system. The layer removed from the system by this change can be so thin that the values of the system's extensive properties are essentially unaffected. With this redefined boundary, the energy transfer across the boundary is entirely by means of heat.

local frame is also inertial but U is not equal to E_{sys} and the change ΔU during a process is not necessarily equal to ΔE_{sys} .

If the origin of the local frame moves with nonconstant velocity in the lab frame, or if the local frame rotates with respect to the lab frame, then the local frame has finite acceleration and is noninertial. In this case the motion of particle i in the local frame does not obey Newton's second law as it does in an inertial frame. We can, however, define an *effective* net force $\mathbf{F}_i^{\text{eff}}$ whose relation to the particle's acceleration in the local frame has the same form as Newton's second law:

$$\mathbf{F}_i^{\text{eff}} = m_i \frac{d\mathbf{v}'_i}{dt} \quad (\text{G.6.1})$$

To an observer who is stationary in the local frame, the effective force will appear to make the particle's motion obey Newton's second law even though the frame is not inertial.

The net force on particle i from interactions with other particles is given by Eq. G.3.1: $\mathbf{F}_i = \sum_{j \neq i} \mathbf{F}_{ij} + \mathbf{F}_i^{\text{field}} + \mathbf{F}_i^{\text{sur}}$. The effective force can be written

$$\mathbf{F}_i^{\text{eff}} = \mathbf{F}_i + \mathbf{F}_i^{\text{accel}} \quad (\text{G.6.2})$$

where $\mathbf{F}_i^{\text{accel}}$ is the contribution due to acceleration. $\mathbf{F}_i^{\text{accel}}$ is not a true force in the sense of resulting from the interaction of particle i with other particles. Instead, it is an apparent or fictitious force introduced to make it possible to write Eq. G.6.1 which resembles Newton's second law. The motion of particle i in an inertial frame is given by $m_i d\mathbf{v}_i/dt = \mathbf{F}_i$, whereas the motion in the local frame is given by $m_i d\mathbf{v}'_i/dt = \mathbf{F}_i + \mathbf{F}_i^{\text{accel}}$.

A simple example may make these statements clear. Consider a small unattached object suspended in the "weightless" environment of an orbiting space station. Assume the object is neither moving nor spinning relative to the station. Let the object be the system, and fix the local frame in the space station. The local frame rotates with respect to local stars as the station orbits around the earth; the local frame is therefore noninertial. The only true force exerted on the object is a gravitational force directed toward the earth. This force explains the object's acceleration relative to local stars. The fact that the object has no acceleration in the local frame can be explained by the presence of a fictitious centrifugal force having the same magnitude as the gravitational force but directed in the opposite direction, so that the *effective* force on the object as a whole is zero.

The reasoning used to derive the equations in Secs. G.1–G.4 can be applied to an arbitrary local frame. To carry out the derivations we replace \mathbf{F}_i by $\mathbf{F}_i^{\text{eff}}$, \mathbf{r}_i by \mathbf{r}'_i , and \mathbf{v}_i by \mathbf{v}'_i , and use the local frame to measure the Cartesian components of all vectors. We need two new potential energy functions for the local frame, defined by the relations

$$\Delta\Phi'_i{}^{\text{field}} \stackrel{\text{def}}{=} - \int \mathbf{F}_i^{\text{field}} \cdot d\mathbf{r}'_i \quad (\text{G.6.3})$$

$$\Delta\Phi'_i{}^{\text{accel}} \stackrel{\text{def}}{=} - \int \mathbf{F}_i^{\text{accel}} \cdot d\mathbf{r}'_i \quad (\text{G.6.4})$$

Both $\Phi'_i{}^{\text{field}}$ and Φ^{accel} must be time-independent functions of the position of particle i in the local frame in order to be valid potential functions. (If the local frame is inertial, $\mathbf{F}_i^{\text{accel}}$ and $\Phi'_i{}^{\text{accel}}$ are zero.)

The detailed line of reasoning in Secs. G.1–G.4 will not be repeated here, but the reader can verify the following results. The *total energy* of the system and surroundings measured

in the *local* frame is given by $E'_{\text{tot}} = U + \sum_i \sum_{k'} \Phi_{ik'} + E'_{\text{surr}}$ where the index k' is for particles in the surroundings that are not the source of an external field for the system. The energy of the *system* (the internal energy) is given by

$$U = \sum_i \frac{1}{2} m_i (v'_i)^2 + \sum_i \sum_{j>i} \Phi_{ij} + \sum_i \Phi'_i{}^{\text{field}} + \sum_i \Phi_i{}^{\text{accel}} \quad (\text{G.6.5})$$

where the indices i and j are for system particles. The energy of the *surroundings* measured in the local frame is

$$E'_{\text{surr}} = \sum_k \frac{1}{2} m_k (v'_k)^2 + \sum_k \sum_{l>k} \Phi_{kl} + \sum_k \Phi_k{}^{\text{accel}} \quad (\text{G.6.6})$$

where k and l are indices for particles in the surroundings. The value of E'_{tot} is found to be constant over time, meaning that energy is conserved in the local frame. The internal energy change during a process is the sum of the heat q measured in the local frame and the macroscopic work w in this frame:

$$\Delta U = q + w \quad (\text{G.6.7})$$

The expressions for q and w , analogous to Eqs. G.4.4 and G.4.2, are found to be

$$q = \sum_{\tau} \sum_i \int \delta_{i\tau} \mathbf{F}_i^{\text{surr}} \cdot d\mathbf{r}_{i\tau} \quad (\text{G.6.8})$$

$$w = \sum_{\tau} \int \mathbf{F}_{\tau}^{\text{surr}} \cdot d\mathbf{R}'_{\tau} \quad (\text{G.6.9})$$

In these equations \mathbf{R}'_{τ} is a vector from the origin of the local frame to a point fixed in the system boundary at segment τ , and $\mathbf{r}_{i\tau}$ is a vector from this point to particle i (see Fig. G.3).

We expect that an observer in the local frame will find the laws of thermodynamics are obeyed. For instance, the Clausius statement of the second law (Sec. 4.2) is as valid in a manned orbiting space laboratory as it is in an earth-fixed laboratory: nothing the investigator can do will allow energy to be transferred by heat from a colder to a warmer body through a device operating in a cycle. Equation G.6.7 is a statement of the first law of thermodynamics (box on page 57) in the local frame. Accordingly, we may assume that the thermodynamic derivations and relations treated in the body of this book are valid in any local frame, whether or not it is inertial, when U and w are defined by Eqs. G.6.5 and G.6.9.

In the body of the book, w is called the *thermodynamic work*, or simply the work. Note the following features brought out by the derivation of the expression for w :

- The equation $w = \sum_{\tau} \int \mathbf{F}_{\tau}^{\text{surr}} \cdot d\mathbf{R}'_{\tau}$ has been derived for a *closed* system.
- The equation shows how we can evaluate the thermodynamic work w done on the system. For each moving surface element of the system boundary at segment τ of the interaction layer, we need to know the contact force $\mathbf{F}_{\tau}^{\text{surr}}$ exerted by the surroundings and the displacement $d\mathbf{R}'_{\tau}$ in the local frame.
- We could equally well calculate w from the force exerted by the *system* on the surroundings. According to Newton's third law, the force $\mathbf{F}_{\tau}^{\text{sys}}$ exerted by segment τ has the same magnitude as $\mathbf{F}_{\tau}^{\text{surr}}$ and the opposite direction: $\mathbf{F}_{\tau}^{\text{sys}} = -\mathbf{F}_{\tau}^{\text{surr}}$.

- During a process, a point fixed in the system boundary at segment τ is either stationary or traverses a path in three-dimensional space. At each intermediate stage of the process, let s_τ be the length of the path that began in the initial state. We can write the infinitesimal quantity $\mathbf{F}_\tau^{\text{sur}} \cdot d\mathbf{R}'_\tau$ in the form $F_\tau^{\text{sur}} \cos \alpha_\tau ds_\tau$, where F_τ^{sur} is the magnitude of the force, ds_τ is an infinitesimal change of the path length, and α_τ is the angle between the directions of the force and the displacement. We then obtain the following integrated and differential forms of the work:

$$w = \sum_\tau \int F_\tau^{\text{sur}} \cos \alpha_\tau ds_\tau \quad \dagger w = \sum_\tau F_\tau^{\text{sur}} \cos \alpha_\tau ds_\tau \quad (\text{G.6.10})$$

- If only one portion of the boundary moves in the local frame, and this portion has linear motion parallel to the x' axis, we can replace $\mathbf{F}_\tau^{\text{sur}} \cdot d\mathbf{R}'_\tau$ by $F_{x'}^{\text{sur}} dx'$, where $F_{x'}^{\text{sur}}$ is the x' component of the force exerted by the surroundings on the moving boundary and dx' is an infinitesimal displacement of the boundary. In this case we can write the following integrated and differential forms of the work:

$$w = \int F_{x'}^{\text{sur}} dx' \quad \dagger w = F_{x'}^{\text{sur}} dx' \quad (\text{G.6.11})$$

- The work w does not include work done internally by one part of the system on another part.
- In the calculation of work with Eqs. G.6.9–G.6.11, we do not include forces from an external field such as a gravitational field, or fictitious forces $\mathbf{F}_i^{\text{accel}}$ if present.

G.7 Nonrotating Local Frame

Consider the case of a nonrotating local frame whose origin moves in the lab frame but whose Cartesian axes x', y', z' remain parallel to the axes x, y, z of the lab frame. In this case the Cartesian components of $\mathbf{F}_i^{\text{sur}}$ for particle i are the same in both frames, and so also are the Cartesian components of the infinitesimal vector displacement $d\mathbf{r}_{i\tau}$. According to Eqs. G.4.4 and G.6.8, then, for an arbitrary process the value of the heat q in the local frame is the same as the value of the heat q_{lab} in the lab frame.

From Eqs. G.4.3 and G.6.7 with q_{lab} set equal to q , we obtain the useful relation

$$\Delta U - \Delta E_{\text{sys}} = w - w_{\text{lab}} \quad (\text{G.7.1})$$

This equation is not valid if the local frame has rotational motion with respect to the lab frame.

The vector \mathbf{R}'_τ has the same Cartesian components in the lab frame as in the nonrotating local frame, so we can write $\mathbf{R}_\tau - \mathbf{R}'_\tau = \mathbf{R}_{\text{loc}}$ where \mathbf{R}_{loc} is the position vector in the lab frame of the origin of the local frame (see Fig. G.3). From Eqs. G.4.2 and G.6.9, setting $(\mathbf{R}_\tau - \mathbf{R}'_\tau)$ equal to \mathbf{R}_{loc} , we obtain the relation

$$w - w_{\text{lab}} = \sum_\tau \int \mathbf{F}_\tau^{\text{sur}} \cdot d(\mathbf{R}'_\tau - \mathbf{R}_\tau) = - \int \left(\sum_\tau \mathbf{F}_\tau^{\text{sur}} \right) \cdot d\mathbf{R}_{\text{loc}} \quad (\text{G.7.2})$$

The sum $\sum_\tau \mathbf{F}_\tau^{\text{sur}}$ is the net contact force exerted on the system by the surroundings. For example, suppose the system is a fluid in a gravitational field. Let the system boundary

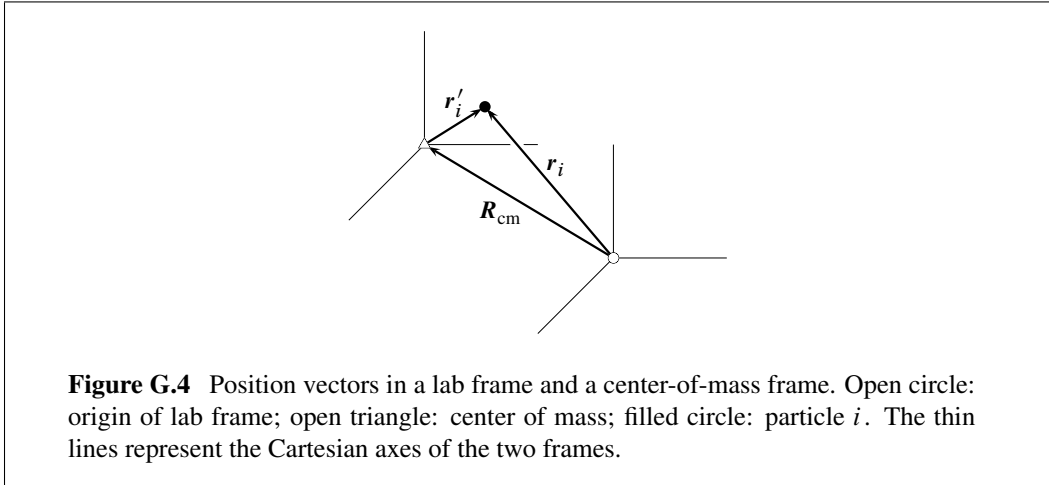

be at the inner walls of the container, and let the local frame be fixed with respect to the container and have negligible acceleration in the lab frame. At each surface element of the boundary, the force exerted by the pressure of the fluid on the container wall is equal in magnitude and opposite in direction to the contact force exerted by the surroundings on the fluid. The horizontal components of the contact forces on opposite sides of the container cancel, but the vertical components do not cancel because of the hydrostatic pressure. The net contact force is $mg\mathbf{e}_z$, where m is the system mass and \mathbf{e}_z is a unit vector in the vertical $+z$ direction. For this example, Eq. G.7.2 becomes

$$w - w_{\text{lab}} = -mg\Delta z_{\text{loc}} \quad (\text{G.7.3})$$

where z_{loc} is the elevation in the lab frame of the origin of the local frame.

G.8 Center-of-mass Local Frame

If we use a *center-of-mass frame* (cm frame) for the local frame, the internal energy change during a process is related in a particularly simple way to the system energy change measured in a lab frame. A cm frame has its origin at the center of mass of the system and its Cartesian axes parallel to the Cartesian axes of a lab frame. This is a special case of the nonrotating local frame discussed in Sec. G.7. Since the center of mass may accelerate in the lab frame, a cm frame is not necessarily inertial.

The indices i and j in this section refer only to the particles in the *system*.

The **center of mass** of the system is a point whose position in the lab frame is defined by

$$\mathbf{R}_{\text{cm}} \stackrel{\text{def}}{=} \frac{\sum_i m_i \mathbf{r}_i}{m} \quad (\text{G.8.1})$$

where m is the system mass: $m = \sum_i m_i$. The position vector of particle i in the lab frame is equal to the sum of the vector \mathbf{R}_{cm} from the origin of the lab frame to the center of mass and the vector \mathbf{r}'_i from the center of mass to the particle (see Fig. G.4):

$$\mathbf{r}_i = \mathbf{R}_{\text{cm}} + \mathbf{r}'_i \quad (\text{G.8.2})$$

We can use Eqs. G.8.1 and G.8.2 to derive several relations that will be needed presently. Because the Cartesian axes of the lab frame and cm frame are parallel to one another (that is, the cm frame does not rotate), we can add vectors or form scalar products using the vector components measured in either frame. The time derivative of Eq. G.8.2 is $d\mathbf{r}_i/dt = d\mathbf{R}_{\text{cm}}/dt + d\mathbf{r}'_i/dt$, or

$$\mathbf{v}_i = \mathbf{v}_{\text{cm}} + \mathbf{v}'_i \quad (\text{G.8.3})$$

where the vector \mathbf{v}_{cm} gives the velocity of the center of mass in the lab frame. Substitution from Eq. G.8.2 into the sum $\sum_i m_i \mathbf{r}_i$ gives $\sum_i m_i \mathbf{r}_i = m\mathbf{R}_{\text{cm}} + \sum_i m_i \mathbf{r}'_i$, and a rearrangement of Eq. G.8.1 gives $\sum_i m_i \mathbf{r}_i = m\mathbf{R}_{\text{cm}}$. Comparing these two equalities, we see the sum $\sum_i m_i \mathbf{r}'_i$ must be zero. Therefore the first and second derivatives of $\sum_i m_i \mathbf{r}'_i$ with respect to time must also be zero:

$$\sum_i m_i \mathbf{v}'_i = 0 \quad \sum_i m_i \frac{d\mathbf{v}'_i}{dt} = 0 \quad (\text{G.8.4})$$

From Eqs. G.1.2, G.6.1, G.6.2, and G.8.3 we obtain

$$\mathbf{F}_i^{\text{accel}} = m_i \frac{d(\mathbf{v}'_i - \mathbf{v}_i)}{dt} = -m_i \frac{d\mathbf{v}_{\text{cm}}}{dt} \quad (\text{G.8.5})$$

Equation G.8.5 is valid only for a nonrotating cm frame.

The difference between the energy changes of the system in the cm frame and the lab frame during a process is given, from Eqs. G.2.6 and G.6.5, by

$$\begin{aligned} \Delta U - \Delta E_{\text{sys}} &= \Delta \left[\sum_i \frac{1}{2} m_i (v'_i)^2 - \sum_i \frac{1}{2} m_i v_i^2 \right] \\ &+ \Delta \left(\sum_i \Phi_i^{\text{field}} - \sum_i \Phi_i^{\text{field}} \right) + \Delta \left(\sum_i \Phi_i^{\text{accel}} \right) \end{aligned} \quad (\text{G.8.6})$$

We will find new expressions for the three terms on the right side of this equation.

The first term is the difference between the total kinetic energy changes measured in the cm frame and lab frame. We can derive an important relation, well known in classical mechanics, for the kinetic energy in the lab frame:

$$\begin{aligned} \sum_i \frac{1}{2} m_i v_i^2 &= \sum_i \frac{1}{2} m_i (\mathbf{v}_{\text{cm}} + \mathbf{v}'_i) \cdot (\mathbf{v}_{\text{cm}} + \mathbf{v}'_i) \\ &= \frac{1}{2} m v_{\text{cm}}^2 + \sum_i \frac{1}{2} m_i (v'_i)^2 + \mathbf{v}_{\text{cm}} \cdot \left(\sum_i m_i \mathbf{v}'_i \right) \end{aligned} \quad (\text{G.8.7})$$

The quantity $\frac{1}{2} m v_{\text{cm}}^2$ is the bulk kinetic energy of the system in the lab frame—that is, the translational energy of a body having the same mass as the system and moving with the center of mass. The sum $\sum_i m_i \mathbf{v}'_i$ is zero (Eq. G.8.4). Therefore the first term on the right side of Eq. G.8.6 is

$$\Delta \left[\sum_i \frac{1}{2} m_i (v'_i)^2 - \sum_i \frac{1}{2} m_i v_i^2 \right] = -\Delta \left(\frac{1}{2} m v_{\text{cm}}^2 \right) \quad (\text{G.8.8})$$

Only by using a nonrotating local frame moving with the center of mass is it possible to derive such a simple relation among these kinetic energy quantities.

The second term on the right side of Eq. G.8.6, with the help of Eqs. G.2.2, G.6.3, and G.8.2 becomes

$$\begin{aligned}\Delta\left(\sum_i\Phi_i^{\prime\text{field}}-\sum_i\Phi_i^{\text{field}}\right) &= -\sum_i\int\mathbf{F}_i^{\text{field}}\cdot d(\mathbf{r}'_i-\mathbf{r}_i) \\ &= \int\left(\sum_i\mathbf{F}_i^{\text{field}}\right)\cdot d\mathbf{R}_{\text{cm}}\end{aligned}\quad (\text{G.8.9})$$

Suppose the only external field is gravitational: $\mathbf{F}_i^{\text{field}} = \mathbf{F}_i^{\text{grav}} = -m_i g \mathbf{e}_z$ where \mathbf{e}_z is a unit vector in the vertical (upward) $+z$ direction. In this case we obtain

$$\begin{aligned}\Delta\left(\sum_i\Phi_i^{\prime\text{field}}-\sum_i\Phi_i^{\text{field}}\right) &= -\int\left(\sum_i m_i\right)g\mathbf{e}_z\cdot d\mathbf{R}_{\text{cm}} \\ &= -mg\int\mathbf{e}_z\cdot d\mathbf{R}_{\text{cm}} = -mg\int dz_{\text{cm}} \\ &= -mg\Delta z_{\text{cm}}\end{aligned}\quad (\text{G.8.10})$$

where z_{cm} is the elevation of the center of mass in the lab frame. The quantity $mg\Delta z_{\text{cm}}$ is the change in the system's bulk gravitational potential energy in the lab frame—the change in the potential energy of a body of mass m undergoing the same change in elevation as the system's center of mass.

The third term on the right side of Eq. G.8.6 can be shown to be zero when the local frame is a cm frame. The derivation uses Eqs. G.6.4 and G.8.5 and is as follows:

$$\begin{aligned}\Delta\left(\sum_i\Phi_i^{\text{accel}}\right) &= -\sum_i\int\mathbf{F}_i^{\text{accel}}\cdot d\mathbf{r}'_i = \sum_i\int m_i\frac{d\mathbf{v}_{\text{cm}}}{dt}\cdot d\mathbf{r}'_i \\ &= \int\left(\sum_i m_i\frac{d\mathbf{r}'_i}{dt}\right)\cdot d\mathbf{v}_{\text{cm}} = \int\left(\sum_i m_i\mathbf{v}'_i\right)\cdot d\mathbf{v}_{\text{cm}}\end{aligned}\quad (\text{G.8.11})$$

The sum $\sum_i m_i \mathbf{v}'_i$ in the integrand of the last integral on the right side is zero (Eq. G.8.4) so the integral is also zero.

With these substitutions, Eq. G.8.6 becomes $\Delta U - \Delta E_{\text{sys}} = -\frac{1}{2}m\Delta(v_{\text{cm}}^2) - mg\Delta z_{\text{cm}}$. Since $\Delta U - \Delta E_{\text{sys}}$ is equal to $w - w_{\text{lab}}$ when the local frame is nonrotating (Eq. G.7.1), we have

$$w - w_{\text{lab}} = -\frac{1}{2}m\Delta(v_{\text{cm}}^2) - mg\Delta z_{\text{cm}}\quad (\text{G.8.12})$$

G.9 Rotating Local Frame

A rotating local frame is the most convenient to use in treating the thermodynamics of a system with rotational motion in a lab frame. A good example of such a system is a solution in a sample cell of a spinning ultracentrifuge (Sec. 9.8.2).

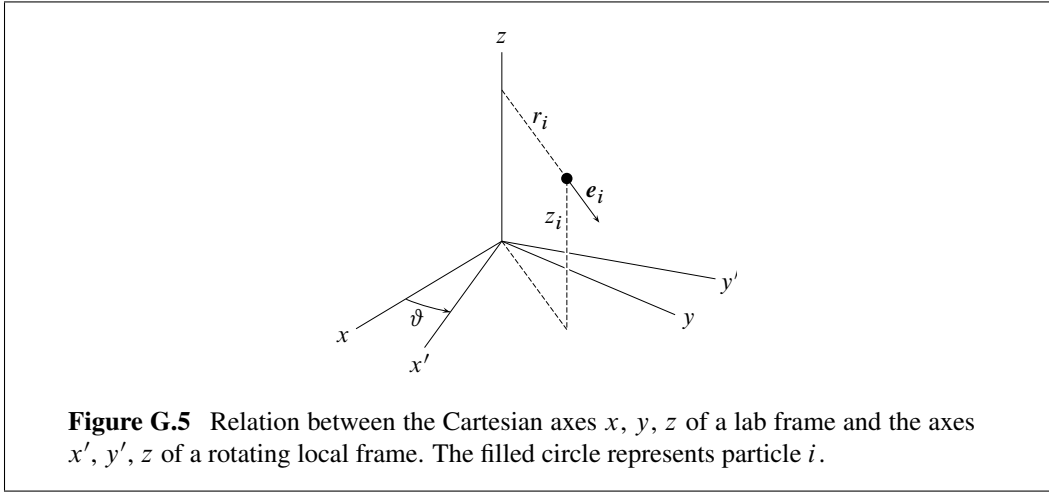

We will make several simplifying assumptions. The rotating local frame has the same origin and the same z axis as the lab frame, as shown in Fig. G.5. The z axis is vertical and is the axis of rotation for the local frame. The local frame rotates with constant angular velocity $\omega = d\vartheta/dt$, where ϑ is the angle between the x axis of the lab frame and the x' axis of the local frame. There is a gravitational force in the $-z$ direction; this force is responsible for the only external field, whose potential energy change in the local frame during a process is $\Delta\Phi_i^{\text{grav}} = m_i g \Delta z_i$ (Eq. G.2.3).

The contribution to the effective force acting on particle i due to acceleration when ω is constant can be shown to be given by⁸

$$\mathbf{F}_i^{\text{accel}} = \mathbf{F}_i^{\text{centr}} + \mathbf{F}_i^{\text{Cor}} \quad (\text{G.9.1})$$

where $\mathbf{F}_i^{\text{centr}}$ is the so-called *centrifugal force* and $\mathbf{F}_i^{\text{Cor}}$ is called the *Coriolis force*.

The centrifugal force acting on particle i is given by

$$\mathbf{F}_i^{\text{centr}} = m_i \omega^2 r_i \mathbf{e}_i \quad (\text{G.9.2})$$

Here r_i is the radial distance of the particle from the axis of rotation, and \mathbf{e}_i is a unit vector pointing from the particle in the direction away from the axis of rotation (see Fig. G.5). The direction of \mathbf{e}_i in the local frame changes as the particle moves in this frame.

The Coriolis force acting on particle i arises only when the particle is moving relative to the rotating frame. This force has magnitude $2m_i\omega v'_i$ and is directed perpendicular to both \mathbf{v}'_i and the axis of rotation.

In a rotating local frame, the work during a process is not the same as that measured in a lab frame. The heats q and q_{lab} are not equal to one another as they are when the local frame is nonrotating, nor can general expressions using macroscopic quantities be written for $\Delta U - \Delta E_{\text{sys}}$ and $w - w_{\text{lab}}$.

G.10 Earth-Fixed Reference Frame

In the preceding sections of Appendix G, we assumed that a lab frame whose coordinate axes are fixed relative to the earth's surface is an inertial frame. This is not exactly true, be-

⁸The derivation, using a different notation, can be found in Ref. [115], Chap. 10.

cause the earth spins about its axis and circles the sun. Small correction terms, a centrifugal force and a Coriolis force, are needed to obtain the effective net force acting on particle i that allows Newton's second law to be obeyed exactly in the lab frame.⁹

The earth's movement around the sun makes only a minor contribution to these correction terms. The Coriolis force, which occurs only if the particle is moving in the lab frame, is usually so small that it can be neglected.

This leaves as the only significant correction the centrifugal force on the particle from the earth's spin about its axis. This force is directed perpendicular to the earth's axis and has magnitude $m_i\omega^2r_i$, where ω is the earth's angular velocity, m_i is the particle's mass, and r_i is the radial distance of the particle from the earth's axis. The correction can be treated as a small modification of the gravitational force acting on the particle that is at most, at the equator, only about 0.3% of the actual gravitational force. Not only is the correction small, but it is completely taken into account in the lab frame when we calculate the effective gravitational force from $\mathbf{F}_i^{\text{grav}} = -m_i g \mathbf{e}_z$, where g is the acceleration of free fall and \mathbf{e}_z is a unit vector in the $+z$ (upward) direction. The value of g is an experimental quantity that includes the effect of $\mathbf{F}_i^{\text{centr}}$, and thus depends on latitude as well as elevation above the earth's surface. Since $\mathbf{F}_i^{\text{grav}}$ depends only on position, we can treat gravity as a conservative force field in the earth-fixed lab frame.

⁹Ref. [73], Sec. 4–9.

APPENDIX H

STANDARD MOLAR THERMODYNAMIC PROPERTIES

The values in this table are for a temperature of 298.15 K (25.00 °C) and the standard pressure $p^\circ = 1$ bar. Solute standard states are based on molality. A crystalline solid is denoted by cr.

Most of the values in this table come from a project of the Committee on Data for Science and Technology (CODATA) to establish a set of recommended, internally consistent values of thermodynamic properties. The values of $\Delta_f H^\circ$ and S_m° shown with uncertainties are values recommended by CODATA.¹

Species	$\frac{\Delta_f H^\circ}{\text{kJ mol}^{-1}}$	$\frac{S_m^\circ}{\text{J K}^{-1} \text{ mol}^{-1}}$	$\frac{\Delta_f G^\circ}{\text{kJ mol}^{-1}}$
<i>Inorganic substances</i>			
Ag(cr)	0	42.55 ± 0.20	0
AgCl(cr)	-127.01 ± 0.05	96.25 ± 0.20	-109.77
C(cr, graphite)	0	5.74 ± 0.10	0
CO(g)	-110.53 ± 0.17	197.660 ± 0.004	-137.17
CO ₂ (g)	-393.51 ± 0.13	213.785 ± 0.010	-394.41
Ca(cr)	0	41.59 ± 0.40	0
CaCO ₃ (cr, calcite)	-1206.9	92.9	-1128.8
CaO(cr)	-634.92 ± 0.90	38.1 ± 0.4	-603.31
Cl ₂ (g)	0	223.081 ± 0.010	0
F ₂ (g)	0	202.791 ± 0.005	0
H ₂ (g)	0	130.680 ± 0.003	0
HCl(g)	-92.31 ± 0.10	186.902 ± 0.005	-95.30
HF(g)	-273.30 ± 0.70	173.779 ± 0.003	-275.40
HI(g)	26.50 ± 0.10	206.590 ± 0.004	1.70
H ₂ O(l)	-285.830 ± 0.040	69.95 ± 0.03	-237.16
H ₂ O(g)	-241.826 ± 0.040	188.835 ± 0.010	-228.58
H ₂ S(g)	-20.6 ± 0.5	205.81 ± 0.05	-33.44

¹Ref. [38]; also available online at <http://www.codata.info/resources/databases/key1.html>.

(continued from previous page)

Species	$\frac{\Delta_f H^\circ}{\text{kJ mol}^{-1}}$	$\frac{S_m^\circ}{\text{J K}^{-1} \text{mol}^{-1}}$	$\frac{\Delta_f G^\circ}{\text{kJ mol}^{-1}}$
Hg(l)	0	75.90 ± 0.12	0
Hg(g)	61.38 ± 0.04	174.971 ± 0.005	31.84
HgO(cr, red)	-90.79 ± 0.12	70.25 ± 0.30	-58.54
Hg ₂ Cl ₂ (cr)	-265.37 ± 0.40	191.6 ± 0.8	-210.72
I ₂ (cr)	0	116.14 ± 0.30	0
K(cr)	0	64.68 ± 0.20	0
KI(cr)	-327.90	106.37	-323.03
KOH(cr)	-424.72	78.90	-378.93
N ₂ (g)	0	191.609 ± 0.004	0
NH ₃ (g)	-45.94 ± 0.35	192.77 ± 0.05	-16.41
NO ₂ (g)	33.10	240.04	51.22
N ₂ O ₄ (g)	9.08	304.38	97.72
Na(cr)	0	51.30 ± 0.20	0
NaCl(cr)	-411.12	72.11	-384.02
O ₂ (g)	0	205.152 ± 0.005	0
O ₃ (g)	142.67	238.92	163.14
P(cr, white)	0	41.09 ± 0.25	0
S(cr, rhombic)	0	32.054 ± 0.050	0
SO ₂ (g)	-296.81 ± 0.20	248.223 ± 0.050	-300.09
Si(cr)	0	18.81 ± 0.08	0
SiF ₄ (g)	-1615.0 ± 0.8	282.76 ± 0.50	-1572.8
SiO ₂ (cr, α-quartz)	-910.7 ± 1.0	41.46 ± 0.20	-856.3
Zn(cr)	0	41.63 ± 0.15	0
ZnO(cr)	-350.46 ± 0.27	43.65 ± 0.40	-320.48
<i>Organic compounds</i>			
CH ₄ (g)	-74.87	186.25	-50.77
CH ₃ OH(l)	-238.9	127.2	-166.6
CH ₃ CH ₂ OH(l)	-277.0	159.9	-173.8
C ₂ H ₂ (g)	226.73	200.93	209.21
C ₂ H ₄ (g)	52.47	219.32	68.43
C ₂ H ₆ (g)	-83.85	229.6	-32.00
C ₃ H ₈ (g)	-104.7	270.31	-24.3
C ₆ H ₆ (l, benzene)	49.04	173.26	124.54
<i>Ionic solutes</i>			
Ag ⁺ (aq)	105.79 ± 0.08	73.45 ± 0.40	77.10
CO ₃ ²⁻ (aq)	-675.23 ± 0.25	-50.0 ± 1.0	-527.90
Ca ²⁺ (aq)	-543.0 ± 1.0	-56.2 ± 1.0	-552.8
Cl ⁻ (aq)	-167.08 ± 0.10	56.60 ± 0.20	-131.22
F ⁻ (aq)	-335.35 ± 0.65	-13.8 ± 0.8	-281.52
H ⁺ (aq)	0	0	0

(continued from previous page)

Species	$\frac{\Delta_f H^\circ}{\text{kJ mol}^{-1}}$	$\frac{S_m^\circ}{\text{J K}^{-1} \text{ mol}^{-1}}$	$\frac{\Delta_f G^\circ}{\text{kJ mol}^{-1}}$
HCO ₃ ⁻ (aq)	-689.93 ± 2.0	98.4 ± 0.5	-586.90
HS ⁻ (aq)	-16.3 ± 1.5	67 ± 5	12.2
HSO ₄ ⁻ (aq)	-886.9 ± 1.0	131.7 ± 3.0	-755.4
Hg ₂ ²⁺ (aq)	166.87 ± 0.50	65.74 ± 0.80	153.57
I ⁻ (aq)	-56.78 ± 0.05	106.45 ± 0.30	-51.72
K ⁺ (aq)	-252.14 ± 0.08	101.20 ± 0.20	-282.52
NH ₄ ⁺ (aq)	-133.26 ± 0.25	111.17 ± 0.40	-79.40
NO ₃ ⁻ (aq)	-206.85 ± 0.40	146.70 ± 0.40	-110.84
Na ⁺ (aq)	-240.34 ± 0.06	58.45 ± 0.15	-261.90
OH ⁻ (aq)	-230.015 ± 0.040	-10.90 ± 0.20	-157.24
S ²⁻ (aq)	33.1	-14.6	86.0
SO ₄ ²⁻ (aq)	-909.34 ± 0.40	18.50 ± 0.40	-744.00

APPENDIX I

ANSWERS TO SELECTED PROBLEMS

- 3.3** (b) $q = -w = 1.00 \times 10^5 \text{ J}$
- 3.4** (c) $w = 1.99 \times 10^3 \text{ J}$, $q = -1.99 \times 10^3 \text{ J}$.
- 3.5** 0.0079%
- 3.6** (c) $V_2 \rightarrow nRV_1/(C_V + nR)$, $T_2 \rightarrow \infty$.
For $C_V = (3/2)nR$, $V_2/V_1 \rightarrow 0.4$.
- 3.11** $9.58 \times 10^3 \text{ s}$ (2 hr 40 min)
- 4.4** $\Delta S = 0.054 \text{ J K}^{-1}$
- 4.5** $\Delta S = 549 \text{ J K}^{-1}$ for both processes;
 $\int \dot{d}q/T_{\text{ext}} = 333 \text{ J K}^{-1}$ and 0.
- 5.4** (a) $S = nR \ln \left[cT^{3/2} \left(\frac{V}{n} - b \right) \right] + \left(\frac{5}{2} \right) nR$
- 5.5** (a) $q = 0$, $w = 1.50 \times 10^4 \text{ J}$,
 $\Delta U = 1.50 \times 10^4 \text{ J}$,
 $\Delta H = 2.00 \times 10^4 \text{ J}$
- (c) $\Delta S = 66.7 \text{ J K}^{-1}$
- 6.1** $S_{\text{m}} \approx 151.6 \text{ J K}^{-1} \text{ mol}^{-1}$
- 7.6** (a) $\alpha = 8.519 \times 10^{-4} \text{ K}^{-1}$
 $\kappa_t = 4.671 \times 10^{-5} \text{ bar}^{-1}$
 $(\partial p/\partial T)_V = 18.24 \text{ bar K}^{-1}$
 $(\partial U/\partial V)_T = 5437 \text{ bar}$
- (b) $\Delta p \approx 1.8 \text{ bar}$
- 7.7** (b) $(\partial C_{p,m}/\partial p)_T = -4.210 \times 10^{-8} \text{ J K}^{-1} \text{ Pa}^{-1} \text{ mol}^{-1}$
- 7.8** (b) $8 \times 10^{-4} \text{ K}^{-1}$
- 7.11** $5.001 \times 10^3 \text{ J}$
- 7.12** $\Delta H = 2.27 \times 10^4 \text{ J}$, $\Delta S = 43.6 \text{ J K}^{-1}$
- 7.13** (a) $C_{p,m}^\circ = 42.3 \text{ J K}^{-1} \text{ mol}^{-1}$
(b) $C_{p,m} \approx 52.0 \text{ J K}^{-1} \text{ mol}^{-1}$
- 7.14** (a) $2.56 \text{ J K}^{-1} \text{ g}^{-1}$
- 7.15** (b) $f = 17.4 \text{ bar}$
- 7.16** (a) $\phi = 0.739$, $f = 148 \text{ bar}$
(b) $B = -7.28 \times 10^{-5} \text{ m}^3 \text{ mol}^{-1}$
- 8.2** (a) $S_{\text{m}}^\circ(\text{l}) = 253.6 \text{ J K}^{-1} \text{ mol}^{-1}$
(b) $\Delta_{\text{vap}}S^\circ = 88.6 \text{ J K}^{-1} \text{ mol}^{-1}$,
 $\Delta_{\text{vap}}H^\circ = 2.748 \times 10^4 \text{ J mol}^{-1}$
- 8.4** $4.5 \times 10^{-3} \text{ bar}$
- 8.5** 19 J mol^{-1}
- 8.6** (a) 352.82 K
(b) $3.4154 \times 10^4 \text{ J mol}^{-1}$
- 8.7** (a) $3.62 \times 10^3 \text{ Pa K}^{-1}$
(b) $3.56 \times 10^3 \text{ Pa K}^{-1}$
(c) 99.60°C
- 8.8** (b) $\Delta_{\text{vap}}H^\circ = 4.084 \times 10^4 \text{ J mol}^{-1}$
- 8.9** 0.93 mol
- 9.2** (b) $V_{\text{A}}(x_{\text{B}} = 0.5) \approx 125.13 \text{ cm}^3 \text{ mol}^{-1}$
 $V_{\text{B}}(x_{\text{B}} = 0.5) \approx 158.01 \text{ cm}^3 \text{ mol}^{-1}$
 $V_{\text{B}}^\infty \approx 157.15 \text{ cm}^3 \text{ mol}^{-1}$
- 9.4** real gas: $p = 1.9743 \text{ bar}$
ideal gas: $p = 1.9832 \text{ bar}$
- 9.5** (a) $x_{\text{N}_2} = 8.83 \times 10^{-6}$
 $x_{\text{O}_2} = 4.65 \times 10^{-6}$
 $y_{\text{N}_2} = 0.763$
 $y_{\text{O}_2} = 0.205$

- (b) $x_{\text{N}_2} = 9.85 \times 10^{-6}$
 $x_{\text{O}_2} = 2.65 \times 10^{-6}$
 $y_{\text{N}_2} = 0.851$
 $y_{\text{O}_2} = 0.117$
- 9.7** (b) $f_{\text{A}} = 0.03167 \text{ bar}$, $f_{\text{A}} = 0.03040 \text{ bar}$
- 9.8** (a) In the mixture of composition
 $x_{\text{A}} = 0.9782$, the activity coefficient is
 $\gamma_{\text{B}} \approx 11.5$.
- 9.9** (d) $k_{\text{H,A}} \approx 680 \text{ kPa}$
- 9.11** Values for $m_{\text{B}}/m^\circ = 20$: $\gamma_{\text{A}} = 1.026$,
 $\gamma_{m,\text{B}} = 0.526$; the limiting
slopes are $d\gamma_{\text{A}}/d(m_{\text{B}}/m^\circ) = 0$,
 $d\gamma_{m,\text{B}}/d(m_{\text{B}}/m^\circ) = -0.09$
- 9.13** $p_{\text{N}_2} = 0.235 \text{ bar}$
 $y_{\text{N}_2} = 0.815$
 $p_{\text{O}_2} = 0.0532 \text{ bar}$
 $y_{\text{O}_2} = 0.185$
 $p = 0.288 \text{ bar}$
- 9.14** (b) $h = 1.2 \text{ m}$
- 9.15** (a) $p(7.20 \text{ cm}) - p(6.95 \text{ cm}) = 1.2 \text{ bar}$
(b) $M_{\text{B}} = 187 \text{ kg mol}^{-1}$
mass binding ratio = 1.37
- 10.2** $\gamma_{\pm} = 0.392$
- 11.1** $\Delta_{\text{r}}H^\circ = -63.94 \text{ kJ mol}^{-1}$
 $K = 4.41 \times 10^{-2}$
- 11.2** (b) $\Delta_{\text{r}}H^\circ$: no change
 $\Delta_{\text{r}}S^\circ$: subtract $0.219 \text{ J K}^{-1} \text{ mol}^{-1}$
 $\Delta_{\text{r}}G^\circ$: add 65 J mol^{-1}
- 11.3** $p(298.15 \text{ K}) = 2.6 \times 10^{-6} \text{ bar}$
 $p(273.15 \text{ K}) = 2.7 \times 10^{-7} \text{ bar}$
- 11.4** (a) $-240.34 \text{ kJ mol}^{-1}$, $-470.36 \text{ kJ mol}^{-1}$,
 $-230.02 \text{ kJ mol}^{-1}$
(b) $-465.43 \text{ kJ mol}^{-1}$
(c) $-39.82 \text{ kJ mol}^{-1}$
- 11.5** $\Delta H = 0.92 \text{ kJ}$
- 11.6** $L_{\text{A}} = -0.405 \text{ J mol}^{-1}$
 $L_{\text{B}} = 0.810 \text{ kJ mol}^{-1}$
- 11.7** (a) State 1:
 $n_{\text{C}_6\text{H}_{14}} = 7.822 \times 10^{-3} \text{ mol}$
 $n_{\text{H}_2\text{O}} = 0.05560 \text{ mol}$
amount of O_2 consumed: 0.07431 mol
State 2:
 $n_{\text{H}_2\text{O}} = 0.11035 \text{ mol}$
 $n_{\text{CO}_2} = 0.04693 \text{ mol}$
mass of $\text{H}_2\text{O} = 1.9880 \text{ g}$
- (b) $V_{\text{m}}(\text{C}_6\text{H}_{14}) = 131.61 \text{ cm}^3 \text{ mol}^{-1}$
 $V_{\text{m}}(\text{H}_2\text{O}) = 18.070 \text{ cm}^3 \text{ mol}^{-1}$
- (c) State 1: $V(\text{C}_6\text{H}_{14}) = 1.029 \text{ cm}^3$
 $V(\text{H}_2\text{O}) = 1.005 \text{ cm}^3$
 $V^{\text{g}} = 348.0 \text{ cm}^3$
State 2:
 $V(\text{H}_2\text{O}) = 1.994 \text{ cm}^3$
 $V^{\text{g}} = 348.0 \text{ cm}^3$
- (d) State 1:
 $n_{\text{O}_2} = 0.429 \text{ mol}$
State 2:
 $n_{\text{O}_2} = 0.355 \text{ mol}$
 $y_{\text{O}_2} = 0.883$
 $y_{\text{CO}_2} = 0.117$
- (e) State 2:
 $p_2 = 27.9 \text{ bar}$
 $p_{\text{O}_2} = 24.6 \text{ bar}$
 $p_{\text{CO}_2} = 3.26 \text{ bar}$
- (f) $f_{\text{H}_2\text{O}}(0.03169 \text{ bar}) = 0.03164 \text{ bar}$
State 1: $f_{\text{H}_2\text{O}} = 0.03234 \text{ bar}$
State 2: $f_{\text{H}_2\text{O}} = 0.03229 \text{ bar}$
- (g) State 1:
 $\phi_{\text{H}_2\text{O}} = 0.925$
 $\phi_{\text{O}_2} = 0.981$
 $f_{\text{O}_2} = 29.4 \text{ bar}$
State 2:
 $\phi_{\text{H}_2\text{O}} = 0.896$
 $\phi_{\text{O}_2} = 0.983$
 $\phi_{\text{CO}_2} = 0.910$
 $f_{\text{O}_2} = 24.2 \text{ bar}$
 $f_{\text{CO}_2} = 2.97 \text{ bar}$
- (h) State 1:
 $n_{\text{H}_2\text{O}}^{\text{g}} = 5.00 \times 10^{-4} \text{ mol}$
 $n_{\text{H}_2\text{O}}^{\text{l}} = 0.05510 \text{ mol}$
State 2: $n_{\text{H}_2\text{O}}^{\text{g}} = 5.19 \times 10^{-4} \text{ mol}$
 $n_{\text{H}_2\text{O}}^{\text{l}} = 0.10983 \text{ mol}$
- (i) State 1:
 $k_{m,\text{O}_2} = 825 \text{ bar kg mol}^{-1}$
 $n_{\text{O}_2} = 3.57 \times 10^{-5} \text{ mol}$
State 2:
 $k_{m,\text{O}_2} = 823 \text{ bar kg mol}^{-1}$
 $k_{m,\text{CO}_2} = 30.8 \text{ bar kg mol}^{-1}$
 $n_{\text{O}_2} = 5.85 \times 10^{-5} \text{ mol}$
 $n_{\text{CO}_2} = 1.92 \times 10^{-4} \text{ mol}$
- (j) H_2O vaporization: $\Delta U = +20.8 \text{ J}$
 H_2O condensation: $\Delta U = -21.6 \text{ J}$

- (k) O₂ dissolution: $\Delta U = -0.35 \text{ J}$
 O₂ desolution: $\Delta U = 0.57 \text{ J}$
 CO₂ desolution: $\Delta U = 3.32 \text{ J}$
- (l) C₆H₁₄(l) compression:
 $\Delta U = -1.226 \text{ J}$
 solution compression:
 $\Delta U = -0.225 \text{ J}$
 solution decompression:
 $\Delta U = 0.414 \text{ J}$
- (m) O₂ compression: $\Delta U = -81 \text{ J}$
 gas mixture: $\text{dB}/\text{dT} = 0.26 \times 10^{-6} \text{ m}^3 \text{ K}^{-1} \text{ mol}^{-1}$
 gas mixture expansion: $\Delta U = 87 \text{ J}$
- (n) $\Delta U = 8 \text{ J}$
- (o) $\Delta_c U^\circ = -4154.4 \text{ kJ mol}^{-1}$
- (p) $\Delta_c H^\circ = -4163.1 \text{ kJ mol}^{-1}$
- 11.8** $\Delta_f H^\circ = -198.8 \text{ kJ mol}^{-1}$
- 11.9** $T_2 = 2272 \text{ K}$
- 11.10** $p(\text{O}_2) = 2.55 \times 10^{-5} \text{ bar}$
- 11.11** (a) $K = 3.5 \times 10^{41}$
 (b) $p_{\text{H}_2} = 2.8 \times 10^{-42} \text{ bar}$
 $N_{\text{H}_2} = 6.9 \times 10^{-17}$
 (c) $t = 22 \text{ s}$
- 11.12** (b) $p \approx 1.5 \times 10^4 \text{ bar}$
- 11.13** (c) $K = 0.15$
- 12.1** (b) $T = 1168 \text{ K}$
 $\Delta_r H^\circ = 1.64 \times 10^5 \text{ J mol}^{-1}$
- 12.4** $K_f = 1.860 \text{ K kg mol}^{-1}$
 $K_b = 0.5118 \text{ K kg mol}^{-1}$
- 12.5** $M_B \approx 5.6 \times 10^4 \text{ g mol}^{-1}$
- 12.6** $\Delta_{\text{sol,B}} H^\circ / \text{kJ mol}^{-1} = -3.06, 0, 6.35$
 $\Delta_{\text{sol,B}} S^\circ / \text{J K}^{-1} \text{ mol}^{-1} = -121.0, -110.2, -88.4$
- 12.7** (a) $m_+^\alpha = m_-^\alpha = 1.20 \times 10^{-3} \text{ mol kg}^{-1}$
 $m_+^\beta = 1.80 \times 10^{-3} \text{ mol kg}^{-1}$
 $m_-^\beta = 0.80 \times 10^{-3} \text{ mol kg}^{-1}$
 $m_P = 2.00 \times 10^{-6} \text{ mol kg}^{-1}$
- 12.8** (a) $p^1 = 2.44 \text{ bar}$
 (b) $f(2.44 \text{ bar}) - f(1.00 \text{ bar}) = 3.4 \times 10^{-5} \text{ bar}$
- 12.10** (a) $x_B = 1.8 \times 10^{-7}$
 $m_B = 1.0 \times 10^{-5} \text{ mol kg}^{-1}$
 (b) $\Delta_{\text{sol,B}} H^\circ = -1.99 \times 10^4 \text{ J mol}^{-1}$
 (c) $K = 4.4 \times 10^{-7}$
 $\Delta_r H^\circ = 9.3 \text{ kJ mol}^{-1}$
- 12.13** (a) $p = 92399.6 \text{ Pa}$, $y_B = 0.965724$
 (b) $\phi_A = 0.995801$
 (c) $f_A = 3164.47 \text{ Pa}$
 (d) $y_B = 0.965608$
 (e) $Z = 0.999319$
 (f) $p = 92347.7 \text{ Pa}$
 (g) $k_{\text{H,B}} = 4.40890 \times 10^9 \text{ Pa}$
- 12.15** (a) $\gamma_{x,B} = 0.9826$
 (b) $x_B = 4.19 \times 10^{-4}$
- 12.16** $K = 1.2 \times 10^{-6}$
- 12.17** (a) $\alpha = 0.129$
 $m_+ = 1.29 \times 10^{-3} \text{ mol kg}^{-1}$
 (b) $\alpha = 0.140$
- 12.18** $\Delta_f H^\circ(\text{Cl}^-, \text{aq}) = -167.15 \text{ kJ mol}^{-1}$
 $S_m^\circ(\text{Cl}^-, \text{aq}) = 56.46 \text{ J K}^{-1} \text{ mol}^{-1}$
- 12.19** (a) $K_s = 1.783 \times 10^{-10}$
- 12.20** (a) $\Delta_r H^\circ = -65.769 \text{ kJ mol}^{-1}$
 (b) $\Delta_f H^\circ(\text{Ag}^+, \text{aq}) = 105.84 \text{ kJ mol}^{-1}$
- 13.1** (a) $F = 4$
 (b) $F = 3$
 (c) $F = 2$
- 13.10** (a) $x_B(\text{top}) = 0.02$, $x_B(\text{bottom}) = 0.31$
 (b) $n_A = 2.1 \text{ mol}$, $n_B = 1.0 \text{ mol}$
- 14.3** (a) $\Delta_r G^\circ = -21.436 \text{ kJ mol}^{-1}$
 $\Delta_r S^\circ = -62.35 \text{ J K}^{-1} \text{ mol}^{-1}$
 $\Delta_r H^\circ = -40.03 \text{ kJ mol}^{-1}$
 (b) $\Delta_f H^\circ(\text{AgCl}, \text{s}) = -127.05 \text{ kJ mol}^{-1}$
 (c) $S_m^\circ(\text{AgCl}, \text{s}) = 96.16 \text{ J K}^{-1} \text{ mol}^{-1}$
 $\Delta_f S^\circ(\text{AgCl}, \text{s}) = -57.93 \text{ J K}^{-1} \text{ mol}^{-1}$
 $\Delta_f G^\circ(\text{AgCl}, \text{s}) = -109.78 \text{ kJ mol}^{-1}$
- 14.4** (b) $\Delta_f H^\circ(\text{AgCl}, \text{s}) = -126.81 \text{ kJ mol}^{-1}$
 $\Delta_f G^\circ(\text{AgCl}, \text{s}) = -109.59 \text{ kJ mol}^{-1}$
- 14.5** $K_s = 1.76 \times 10^{-10}$
- 14.6** (b) $\gamma_{\pm} = 0.756$

14.7 (b) $\Delta_r G^\circ = -210.72 \text{ kJ mol}^{-1}$

(c) $K_s = 1.4 \times 10^{-18}$

14.8 $E^\circ = 0.071 \text{ V}$

14.9 (c) $E_{\text{cell, eq}}^\circ = 1.36 \text{ V}$

(d) In the cell:

$$\ddagger q / d\xi = 2.27 \text{ kJ mol}^{-1}$$

In a reaction vessel:

$$\ddagger q / d\xi = -259.67 \text{ kJ mol}^{-1}$$

(e) $dE_{\text{cell, eq}}^\circ / dT = 3.9 \times 10^{-5} \text{ V K}^{-1}$

BIBLIOGRAPHY

- [1] C. J. Adkins, *Equilibrium Thermodynamics*, 3rd edition. Cambridge University Press, Cambridge, 1983.
- [2] Robert A. Alberty, "Use of Legendre Transforms in Chemical Thermodynamics (IUPAC Technical Report)." *Pure Appl. Chem.*, **73**, 1349–1380 (2001).
- [3] S. Angus, B. Armstrong, and K. M. de Reuck, *International Thermodynamic Tables of the Fluid State. Vol. 3. Carbon Dioxide*. Pergamon Press, Oxford, 1976.
- [4] Roger G. Bates and Vincent E. Bower, "Standard Potential of the Silver–Silver-Chloride Electrode from 0° to 95°C and the Thermodynamic Properties of Dilute Hydrochloric Acid Solutions." *J. Res. Natl. Bur. Stand. (U.S.)*, **53**, 283–290 (1954).
- [5] Stuart J. Bates and H. Darwin Kirschman, "The Vapor Pressures and Free Energies of the Hydrogen Halides in Aqueous Solution; the Free Energy of Formation of Hydrogen Chloride." *J. Am. Chem. Soc.*, **41**, 1991–2001 (1919).
- [6] Robert P. Bauman, "Work of Compressing an Ideal Gas." *J. Chem. Educ.*, **41**, 102–104 (1964).
- [7] Robert P. Bauman, "Maximum Work Revisited (letter)." *J. Chem. Educ.*, **41**, 675 (1964).
- [8] Robert P. Bauman, "Maximum Work Revisited (letter)." *J. Chem. Educ.*, **41**, 676–677 (1964).
- [9] Robert P. Bauman and Howard L. Cockerham III, "Pressure of an Ideal Gas on a Moving Piston." *Am. J. Phys.*, **37**, 675–679 (1969).
- [10] Hassan Behnejad, Jan V. Sengers, and Mikhail A. Anisimov, "Thermodynamic Behaviour of Fluids near Critical Points." In A. R. H. Goodwin, J. V. Sengers, and C. J. Peters, editors, *Applied Thermodynamics of Fluids*, pages 321–367. Royal Society of Chemistry, Cambridge, 2010.
- [11] Dor Ben-Amotz and J. M. Honig, "Rectification of Thermodynamic Inequalities." *J. Chem. Phys.*, **118**, 5932–5936 (2003).
- [12] George C. Benson and Osamu Kiyohara, "Thermodynamics of Aqueous Mixtures of Nonelectrolytes. I. Excess Volumes of Water - n-Alcohol Mixtures at Several Temperatures." *J. Solution Chem.*, **9**, 791–804 (1980).
- [13] K. H. Berry, "NPL-75: A Low Temperature Gas Thermometry Scale from 2.6 K to 27.1 K." *Metrologia*, **15**, 89–115 (1979).
- [14] Gary L. Bertrand, "Thermodynamic Calculation of Work for Some Irreversible Processes." *J. Chem. Educ.*, **82**, 874–877 (2005).
- [15] R. W. Blue and W. F. Giauque, "The Heat Capacity and Vapor Pressure of Solid and Liquid Nitrous Oxide. The Entropy from its Band Spectrum." *J. Am. Chem. Soc.*, **57**, 991–997 (1935).
- [16] M. Boirac, "Nécrologie: François Raoult, Discours de M. Boirac, Recteur." *Ann. l'Université de Grenoble*, **13**, i–v (1901).
- [17] J. T. Bottomley, "Scientific Worthies. XX.—James Prescott Joule." *Nature*, **26**, 617–620 (1882).

- [18] Pascale Boulanger, Marc le Maire, Mélanie Bonhivers, Sandrine Dubois, Michel Desmadril, and Lucienne Letellier, "Purification and Structural and Functional Characterization of FhuA, a Transporter of the Escherichia coli Outer Membrane." *Biochemistry*, **14**, 14216–14224 (1996).
- [19] Vincenzo Brandani, Angelo Chianese, and Maurizio Rossi, "Ternary Liquid-Liquid Equilibrium Data for the Water-Ethanol-Benzene System." *J. Chem. Eng. Data*, **30**, 27–29 (1985).
- [20] L. K. Brice, "Le Chatelier's Principle: The Effect of Temperature on the Solubility of Solids in Liquids." *J. Chem. Educ.*, **60**, 387–389 (1983).
- [21] P. W. Bridgman, *The Thermodynamics of Electrical Phenomena in Metals and a Condensed Collection of Thermodynamic Formulas*. Dover, New York, 1961.
- [22] P. W. Bridgman, "A Complete Collection of Thermodynamic Formulas." *Phys. Rev.*, **3**, 273–281 (1914).
- [23] P. W. Bridgman, *The Nature of Thermodynamics*. Harvard University Press, Cambridge, Massachusetts, 1941.
- [24] I. Brown, W. Fock, and F. Smith, "Thermodynamic Properties of Alcohol Solutions." *Aust. J. Chem.*, **9**, 364–372 (1956).
- [25] Oliver L. I. Brown and George G. Manov, "The Heat Capacity of Carbon Disulfide from 15 to 300°K. The Entropy and Heat of Fusion of Carbon Disulfide." *J. Am. Chem. Soc.*, **59**, 500–502 (1937).
- [26] Sadi Carnot, "Reflections on the Motive Power of Fire, and on Machines Fitted to Develop that Power." In E. Mendoza, editor, *Reflections on the Motive Power of Fire: Sadi Carnot and other Papers on the Second Law of Thermodynamics by É. Clapeyron and R. Clausius*, pages 1–59. Dover, Mineola, New York, 1988. Translation by R. H. Thurston of *Réflexions sur la Puissance Motrice du Feu et sur les Machines Propres à Développer cette Puissance*, Bachelier, Paris, 1824.
- [27] L. S. Chao, S. Schlamminger, D. B. Newell, J. R. Pratt, F. Seifert, X. Zhang, G. Sineriz, M. Liu, and D. Haddad, "A LEGO Watt Balance: An Apparatus to Determine a Mass Based on the New SI." *Am. J. Phys.*, **83**, 913–922 (2015).
- [28] Malcolm W. Chase Jr., *NIST-JANAF Thermochemical Tables*, Fourth edition. American Institute of Physics, Woodbury, New York, 1998. Appeared as *J. Phys. Chem. Ref. Data*, Monograph 9.
- [29] John P. Chesick, "Maximum Work Revisited (letter)." *J. Chem. Educ.*, **41**, 674–675 (1964).
- [30] É. Clapeyron, "Memoir on the Motive Power of Heat." In E. Mendoza, editor, *Reflections on the Motive Power of Fire: Sadi Carnot and other Papers on the Second Law of Thermodynamics by É. Clapeyron and R. Clausius*, pages 71–105. Dover, Mineola, New York, 1988. Translation by E. Mendoza of "Mémoire sur la Puissance Motrice de la Chaleur," *J. de l'École Polytechnique*, **14**, 153–190 (1834).
- [31] E. Colin W. Clarke and David N. Glew, "Evaluation of Thermodynamic Functions for Aqueous Sodium Chloride from Equilibrium and Calorimetric Measurements below 154°C." *J. Phys. Chem. Ref. Data*, **14**, 489–610 (1985).
- [32] R. Clausius, "Fourth Memoir. On a Modified Form of the Second Fundamental Theorem in the Mechanical Theory of Heat." In T. Archer Hirst, editor, *The Mechanical Theory of Heat, with its Applications to the Steam-Engine and to the Physical Properties of Bodies*, pages 11–135. John Van Voorst, London, 1867. Translation of "Ueber eine Veränderte Form des Zweiten Hauptsatzes der Mechanischen Wärmetheorie," *Ann. Phys. Chem. (Leipzig)*, **93**, 481–506 (1854).
- [33] R. Clausius, "Ninth Memoir. On Several Convenient Forms of the Fundamental Equations of the Mechanical Theory of Heat." In T. Archer Hirst, editor, *The Mechanical Theory of Heat, with its Applications to the Steam-Engine and to the Physical Properties of Bodies*, pages 327–365. John Van Voorst, London, 1867. Translation of "Ueber Verschiedene für die Anwendung Bequeme Formen der Hauptgleichungen der Mechanischen Wärmetheorie," *Ann. Phys. Chem. (Leipzig)*, **125**, 353–400 (1865).

- [34] J. O. Clayton and W. F. Giauque, "The Heat Capacity and Entropy of Carbon Monoxide. Heat of Vaporization. Vapor Pressures of Solid and Liquid. Free Energy to 5000°K from Spectroscopic Data." *J. Am. Chem. Soc.*, **54**, 2610–2626 (1932).
- [35] Patrick Coffey, *Cathedrals of Science: The Personalities and Rivalries That Made Modern Chemistry*. Oxford University Press, New York, 2008.
- [36] E. Richard Cohen, Tomislav Cvitaš, Jeremy G. Frey, Bertil Holmström, Kozo Kuchitsu, Roberto Marquardt, Ian Mills, Franco Pavese, Martin Quack, Jürgen Stohner, Herbert L. Strauss, Michio Takami, and Anders J Thor, *Quantities, Units and Symbols in Physical Chemistry*, 3rd edition. RSC Publishing, Cambridge, 2007.
- [37] Roger Cohen-Adad and John W. Lorimer, *Alkali Metal and Ammonium Chlorides in Water and Heavy Water (Binary Systems)*. Solubility Data Series, Vol. 47. Pergamon Press, Oxford, 1991.
- [38] J. D. Cox, D. D. Wagman, and V. A. Medvedev, *CODATA Key Values for Thermodynamics*. Hemisphere Publishing Corp., New York, 1989.
- [39] William H. Cropper, "Walther Nernst and the Last Law." *J. Chem. Educ.*, **64**, 3–8 (1987).
- [40] Rosa Crovetto, "Evaluation of Solubility Data of the System CO₂-H₂O from 273 K to the Critical Point of Water." *J. Phys. Chem. Ref. Data*, **20**, 575–589 (1991).
- [41] Thomas W. Davis, "A Common Misunderstanding of Hess's Law." *J. Chem. Educ.*, **28**, 584–585 (1951).
- [42] Joseph de Heer, *Phenomenological Thermodynamics With Applications To Chemistry*. Prentice-Hall, Englewood Cliffs, New Jersey, 1986.
- [43] J. de Swann Arons and G. A. M. Diepen, "Gas-Gas Equilibria." *J. Chem. Phys.*, **44**, 2322–2330 (1966).
- [44] Peter Debye. Interviewed by C. Uhlenbeck on 3 May, 1962, Niels Bohr Library & Archives, American Institute of Physics, College Park, MD USA, online at http://www.aip.org/history/ohilist/4568_2.html.
- [45] Howard DeVoe, "Particle Model for Work, Heat, and the Energy of a Thermodynamic System." *J. Chem. Educ.*, **84**, 504–512 (2007).
- [46] Howard DeVoe, "A Comparison of Local and Global Formulations of Thermodynamics." *J. Chem. Educ.*, **90**, 591–597 (2013).
- [47] Hilyard John Eglinton Dobson, "The Partial Pressures of Aqueous Ethyl Alcohol." *J. Chem. Soc.*, **127**, 2866–2873 (1925).
- [48] Frederick G. Donnan, "Prof. J. H. van't Hoff." *Nature*, **86**, 84–86 (1911).
- [49] J. H. Dymond and E. B. Smith, *The Virial Coefficients of Pure Gases and Mixtures, A Critical Compilation*. Clarendon Press, Oxford, 1980.
- [50] A. E. Edwards and W. E. Roseveare, "The Second Virial Coefficients of Gaseous Mixtures." *J. Am. Chem. Soc.*, **64**, 2816–2819 (1942).
- [51] D. Eisenberg and W. Kauzmann, *The Structure and Properties of Water*. Oxford University Press, New York, 1969.
- [52] Rodney P. Elliot, *Constitution of Binary Alloys, First Supplement*. McGraw-Hill, New York, 1965.
- [53] C. W. F. Everitt, "Maxwell's Scientific Papers." *Applied Optics*, **6**, 639–646 (1967).
- [54] M. B. Ewing, T. H. Lilley, G. M. Olofsson, M. T. Rätzsch, and G. Somsen, "Standard Quantities in Chemical Thermodynamics. Fugacities, Activities, and Equilibrium Constants for Pure and Mixed Phases (IUPAC Recommendations 1994)." *Pure Appl. Chem.*, **66**, 533–552 (1994).
- [55] G. Faita, P. Longhi, and T. Mussini, "Standard Potentials of the Cl₂/Cl⁻ Electrode at Various Temperatures with Related Thermodynamic Functions." *J. Electrochem. Soc.*, **114**, 340–343 (1967).
- [56] B. Fellmuth, J. Fischer, G. Machin, S. Picard, P. P. M. Steur, O. Tamura, D. R. White, and H. Yoon, "The Kelvin Redefinition and its *Mise en Pratique*." *Phil. Trans. R. Soc. A*, **374**, 20150037 (2016).
- [57] P. Ferloni and G. Spinolo, *Int. DATA Ser., Sel. Data Mixtures, Ser. A*, 70 (1974).

- [58] Enrico Fermi, *Thermodynamics*. Dover, New York, 1956. Republication of book originally published by Prentice-Hall in 1937.
- [59] Alexander Findlay and A. N. Campbell, *The Phase Rule and Its Applications*, 8th edition. Dover, New York, 1945.
- [60] J. Fischer, "Low Uncertainty Boltzmann Constant Determinations and the Kelvin Redefinition." *Phil. Trans. R. Soc. A*, **374**, 20150038 (2016).
- [61] Kai Fischer and Jurgen Gmehling, "P-x and γ^∞ Data for the Different Binary Butanol-Water Systems at 50 °C." *J. Chem. Eng. Data*, **39**, 309–315 (1994).
- [62] George Fleck, "Peter Debye." In Laylin K. James, editor, *Nobel Laureates in Chemistry, 1901–1992*, pages 228–235. Chemical Heritage Foundation, 1993.
- [63] W. F. Giaque and D. P. MacDougall, "Attainment of Temperatures Below 1° Absolute by Demagnetization of $\text{Gd}_2(\text{SO}_4)_3 \cdot 8\text{H}_2\text{O}$." *Phys. Rev.*, **43**, 768 (1933).
- [64] W. F. Giaque and J. W. Stout, "The Entropy of Water and the Third Law of Thermodynamics. The Heat Capacity of Ice from 15 to 273°K." *J. Am. Chem. Soc.*, **58**, 1144–1150 (1936).
- [65] W. F. Giaque and R. Wiebe, "The Entropy of Hydrogen Chloride. Heat Capacity from 16°K. to Boiling Point. Heat of Vaporization. Vapor Pressures of Solid and Liquid." *J. Am. Chem. Soc.*, **50**, 101–122 (1928).
- [66] William F. Giaque. "Some Consequences of Low Temperature Research in Chemical Thermodynamics: Nobel Lecture, December 12, 1949." Online at http://nobelprize.org/nobel_prizes/chemistry/laureates/1949/giaque-lecture.pdf.
- [67] J. Willard Gibbs, "Graphical Methods in the Thermodynamics of Fluids." In Henry Andrews Bumstead and Ralph Gibbs Van Name, editors, *The Scientific Papers of J. Willard Gibbs, Ph.D., LL.D.*, Vol. I, *Thermodynamics*, pages 1–32. Ox Bow Press, Woodbridge, Connecticut, 1993. Reprint of book originally published by Longmans, Green in 1906.
- [68] J. Willard Gibbs, "A Method of Geometrical Representation of the Thermodynamic Properties of Substances by Means of Surfaces." In Henry Andrews Bumstead and Ralph Gibbs Van Name, editors, *The Scientific Papers of J. Willard Gibbs, Ph.D., LL.D.*, Vol. I, *Thermodynamics*, pages 33–54. Ox Bow Press, Woodbridge, Connecticut, 1993. Reprint of book originally published by Longmans, Green in 1906.
- [69] J. Willard Gibbs, "On the Equilibrium of Heterogeneous Substances." In Henry Andrews Bumstead and Ralph Gibbs Van Name, editors, *The Scientific Papers of J. Willard Gibbs, Ph.D., LL.D.*, Vol. I, *Thermodynamics*, pages 55–353. Ox Bow Press, Woodbridge, Connecticut, 1993. Reprint of book originally published by Longmans, Green in 1906.
- [70] R. E. Gibson and O. H. Loeffler, "Pressure-Volume-Temperature Relations in Solutions. II. The Energy-Volume Coefficients of Aniline, Nitrobenzene, Bromobenzene and Chlorobenzene." *J. Am. Chem. Soc.*, **61**, 2515–2522 (1939).
- [71] R. T. Glazebrook, "Joule, James Prescott." In Sidney Lee, editor, *Dictionary of National Biography*, Vol. 30, pages 208–214. Macmillan, New York, 1892.
- [72] J. A. Gledhill and G. McP. Malan, "The Solubilities of Sparingly Soluble Salts in Water." *Trans. Faraday Soc.*, **48**, 258–262 (1952).
- [73] Herbert Goldstein, *Classical Mechanics*. Addison-Wesley, Cambridge, Massachusetts, 1950.
- [74] Sandra C. Greer, M. R. Moldover, and R. Hocken, "A Differential Transformer as a Position Detector in a Magnetic Densimeter." *Rev. Sci. Instrum.*, **45**, 1462–1463 (1974).
- [75] Ulrich Grigull, Johannes Straub, and Peter Schiebener, *Steam Tables in SI-Units*. Springer-Verlag, Berlin, 1990.
- [76] E. A. Guggenheim, *Thermodynamics: An Advanced Treatment for Chemists and Physicists*, 7th edition. North-Holland, Amsterdam, 1985.
- [77] Stuart R. Gunn and Leroy G. Green, "Heat of Solution of Hydrogen Chloride." *J. Chem. Eng. Data*, **8**, 180 (1963).
- [78] D. Haddad, F. Seifert, L. S. Chao, S. Li, D. B. Newell, J. R. Pratt, C. Williams, and S. Schlamming, "A Precise Instrument to Determine the Planck Constant, and the Future Kilogram." *Rev. Sci. Instrum.*, **87**, 061301 (2016).

- [79] Herbert S. Harned and Russell W. Ehlers, "The Dissociation Constant of Acetic Acid from 0 to 35°C Centigrade." *J. Am. Chem. Soc.*, **54**, 1350–1357 (1932).
- [80] Herbert S. Harned and Benton B. Owen, *The Physical Chemistry of Electrolytic Solutions*, 3rd edition. Reinhold, New York, 1958.
- [81] George N. Hatsopoulos and Joseph H. Keenan, *Principles of General Thermodynamics*. Wiley, 1965.
- [82] William Henry, "Experiments on the Quantity of Gases Absorbed by Water, at Different Temperatures, and under Different Pressures." *Philos. Trans. R. Soc. London*, **93**, 29–42 (1803).
- [83] William Henry, "Appendix to Mr. William Henry's Paper, on the Quantity of Gases Absorbed by Water, at Different Temperatures, and under Different Pressures." *Philos. Trans. R. Soc. London*, **93**, 274–276 (1803).
- [84] H. Hess, "Thermochemische Untersuchungen." *Ann. Phys. Chem. (Leipzig)*, **50**, 385–404 (1840).
- [85] Joel H. Hildebrand and Robert L. Scott, *The Solubility of Nonelectrolytes*, 3rd edition. Dover, New York, 1964. Corrected republication of the 3rd (1950) edition.
- [86] Joel H. Hildebrand and Robert L. Scott, *Regular Solutions*. Prentice-Hall, Englewood Cliffs, New Jersey, 1962.
- [87] Joseph Hirsch, "Clapeyron." In *École Polytechnique: Livre du Centenaire, 1794–1894*, Vol. I, pages 194–198. Gauthier-Villars et fils, Paris, 1895. Online at <http://www.anales.org/archives/x/clapeyron.html>.
- [88] J. M. Honig and Dor Ben-Amotz, "The Analysis of Spontaneous Processes Using Equilibrium Thermodynamics." *J. Chem. Educ.*, **83**, 132–137 (2006).
- [89] Irmgard K. Howard, "S Is for Entropy. U is for Energy. What Was Clausius Thinking?" *J. Chem. Educ.*, **78**, 505–508 (2001).
- [90] H. L. Johnston and W. F. Giaque, "The Heat Capacity of Nitric Oxide from 14°K. to the Boiling Point and the Heat of Vaporization. Vapor Pressures of Solid and Liquid Phases. The Entropy from Spectroscopic Data." *J. Am. Chem. Soc.*, **51**, 3194–3214 (1929).
- [91] James Prescott Joule, "On the Mechanical Equivalent of Heat." *Philos. Trans. R. Soc. London*, **140**, 61–82 (1850).
- [92] Michael Kasha, "The Triplet State. An Example of G. N. Lewis' Research Style." *J. Chem. Educ.*, **61**, 204–215 (1984).
- [93] W. B. Kay, "Liquid-Vapor Phase Equilibria Relations in the Ethane–n-Heptane System." *Ind. Eng. Chem.*, **30**, 459–465 (1938).
- [94] Joseph H. Keenan, Frederick G. Keyes, Philip G. Hill, and Joan G. Moore, *Steam Tables. Thermodynamic Properties of Water Including Vapor, Liquid, and Solid Phases*. Krieger Publishing Company, Malabar, Florida, 1992.
- [95] George S. Kell, "Density, Thermal Expansivity, and Compressibility of Liquid Water from 0° to 150°C: Correlations and Tables for Atmospheric Pressure and Saturation Reviewed and Expressed on 1968 Temperature Scale." *J. Chem. Eng. Data*, **20**, 97–105 (1975).
- [96] Lord Kelvin, "On an Absolute Thermometric Scale Founded on Carnot's Theory of the Motive Power of Heat, and Calculated from Regnault's Observations." *Philos. Mag.*, **33**, 313–317 (1848). Online at <http://zapatopi.net/kelvin/papers/>.
- [97] Milton Kerker, "Sadi Carnot and the Steam Engine Engineers." *Isis*, **51**, 257–270 (1960).
- [98] Albert S. Keston, "A Silver–Silver Bromide Electrode Suitable for Measurements in Very Dilute Solutions." *J. Am. Chem. Soc.*, **57**, 1671–1673 (1935).
- [99] Daniel Kivelson and Irwin Oppenheim, "Work in Irreversible Expansions." *J. Chem. Educ.*, **43**, 233–235 (1966).
- [100] Jan T. Knuiman, Peter A. Barneveld, and Nicolaas A. M. Besseling, "On the Relation between the Fundamental Equation of Thermodynamics and the Energy Balance Equation in the Context of Closed and Open Systems." *J. Chem. Educ.*, **89**, 968–972 (2012).
- [101] Angela Köhler-Krützfeld and Klaus Christmann. "Hermann Heinrich Hess," online at http://www.chemiedidaktik.uni-oldenburg.de/download/Hermann_Heinrich_

- [Hess.pdf](#) (accessed July 2011).
- [102] Richard J. Kokes, "Maximum Work Revisited (letter)." *J. Chem. Educ.*, **41**, 675–676 (1964).
- [103] Frank L. Lambert, "Entropy Is Simple, Qualitatively." *J. Chem. Educ.*, **79**, 1241–1246 (2002).
- [104] Frank L. Lambert and Harvey S. Leff, "The Correlation of Standard Entropy with Enthalpy Supplied from 0 to 298.15 K." *J. Chem. Educ.*, **86**, 94–98 (2009).
- [105] Harvey S. Leff, "Multisystem Temperature Equilibration and the Second Law." *Am. J. Phys.*, **45**, 252–254 (1977).
- [106] Harvey S. Leff, "Thermodynamic Entropy: The Spreading and Sharing of Energy." *Am. J. Phys.*, **64**, 1261–1271 (1996).
- [107] Henry M. Leicester, "Germain Henri Hess and the Foundation of Thermochemistry." *J. Chem. Educ.*, **28**, 581–583 (1951).
- [108] Gilbert N. Lewis and Merle Randall, "The Activity Coefficient of Strong Electrolytes." *J. Am. Chem. Soc.*, 1112–1154 (1921).
- [109] Gilbert Newton Lewis, "A New Conception of Thermal Pressure and a Theory of Solutions." *Proc. Am. Acad. Arts and Sciences*, **36**, 145–168 (1900).
- [110] Gilbert Newton Lewis and Merle Randall, *Thermodynamics and the Free Energy of Chemical Substances*. McGraw-Hill, New York, 1923.
- [111] Gilbert Newton Lewis and Merle Randall, *Thermodynamics*, 2nd edition. McGraw-Hill, New York, 1961. Revised by Kenneth S. Pitzer and Leo Brewer.
- [112] David R. Lide (editor), *CRC Handbook of Chemistry and Physics*, 73rd edition. CRC Press, Boca Raton, Florida, 1992.
- [113] Thomas S. Logan, "Textbook Errors: Guest Column. XVI: The Vapor Pressure of Hydrated Cupric Sulfate." *J. Chem. Educ.*, **35**, 148–149 (1958).
- [114] F. H. MacDougall, *Thermodynamics and Chemistry*, 3rd edition. Wiley, New York, 1939.
- [115] Jerry B. Marion and Stephen T. Thornton, *Classical Dynamics of Particles and Systems*, 4th edition. Harcourt Brace, New York, 1995.
- [116] K. N. Marsh, *Int. DATA Ser., Sel. Data Mixtures, Ser. A*, **2**, 73 (1974).
- [117] T. A. Mary, J. S. O. Evans, T. Vogt, and A. W. Sleight, "Negative Thermal Expansion from 0.3 to 1050 Kelvin in ZrW_2O_8 ." *Science*, **272**, 90–92 (1996).
- [118] James Clerk Maxwell, *Theory of Heat*, 9th edition. Longmans, Green and Co., London, 1888.
- [119] M. L. McGlashan, "Deviations from Raoult's Law." *J. Chem. Educ.*, **40**, 516–518 (1963).
- [120] M. L. McGlashan, *Chemical Thermodynamics*. Academic Press, London, 1979.
- [121] M. L. McGlashan, "The International Temperature Scale of 1990 (ITS-90)." *J. Chem. Thermodyn.*, **22**, 653–663 (1990).
- [122] E. Mendoza, *Reflections on the Motive Power of Fire: Sadi Carnot and other Papers on the Second Law of Thermodynamics*. Dover, Mineola, New York, 1988.
- [123] A. Michels, B. Blaisse, and C. Michels, "The Isotherms of CO_2 in the Neighbourhood of the Critical Point and Round the Coexistence Line." *Proc. R. Soc. London, Ser. A*, **160**, 358–375 (1937).
- [124] Robert A. Millikan, "Walther Nernst, a Great Physicist, Passes." *Scientific Monthly*, **54**, 84–86 (1942). Online at http://www.nernst.de/nernst_millikan1942.htm.
- [125] I. M. Mills, "The Choice of Names and Symbols for Quantities in Chemistry." *J. Chem. Educ.*, **66**, 887–889 (1989).
- [126] Ian Mills, Tomislav Cvitaš, Klaus Homann, Nikola Kallay, and Kozo Kuchitsu, *Quantities, Units and Symbols in Physical Chemistry*. Blackwell, Oxford, 1988.
- [127] Ian Mills, Tomislav Cvitaš, Klaus Homann, Nikola Kallay, and Kozo Kuchitsu, *Quantities, Units and Symbols in Physical Chemistry*, 2nd edition. Blackwell, Oxford, 1993.
- [128] M. R. Moldover, R. M. Gavisoso, J. B. Mehl, L. Pitre, M. de Podesta, and J. T. Zhang, "Acoustic Gas Thermometry." *Metrologia*, **51**, R1–R19 (2014).
- [129] Karol J. Mysels, "Maximum Work Revisited (letter)." *J. Chem. Educ.*, **41**, 677 (1964).
- [130] R. Negishi, "The Solubility of Solid Benzene in Several Non-Polar Liquids." *Rev. Phys.*

- Chem. Japan*, **15**, 98–116 (1941).
- [131] Nobelprize.org, *Jacobus H. van't Hoff - Biography*. 1901. Online at http://nobelprize.org/nobel_prizes/chemistry/laureates/1901/hoff-bio.html.
- [132] John D. Norton, "The Impossible Process: Thermodynamic Reversibility." *Studies in History and Philosophy of Modern Physics*, **55**, 43–61 (2016).
- [133] National Institute of Standards and Technology, *NIST Chemistry WebBook*. Online at <http://webbook.nist.gov/chemistry/>.
- [134] John W. Owens, Stanley P. Wasik, and Howard DeVoe, "Aqueous Solubilities and Enthalpies of Solution of n-Alkylbenzenes." *J. Chem. Eng. Data*, **31**, 47–51 (1986).
- [135] Vivian B. Parker, *Thermal Properties of Aqueous Uni-Univalent Electrolytes*. National Standard Data Reference Series. National Bureau of Standards (U.S.), 1965.
- [136] Wolfgang Pauli, *Pauli Lectures on Physics: Volume 3. Thermodynamics and the Kinetic Theory of Gases*. MIT Press, Cambridge, Massachusetts, 1973. Edited by Charles P. Enz.
- [137] M. W. Pestak, Raymond E. Goldstein, M. H. W. Chan, J. R. de Bruyn, D. A. Balzarini, and N. W. Ashcroft, "Three-body Interactions, Scaling Variables, and Singular Diameters in the Coexistence Curves of Fluids." *Phys. Rev. B*, **36**, 599–614 (1987).
- [138] J. C. Philip, "Freezing-Point Curves for some Binary Mixtures of Organic Substances, Chiefly Phenols and Amines." *J. Chem. Soc.*, **83**, 814–834 (1903).
- [139] A. B. Pippard, *Elements of Classical Thermodynamics for Advanced Students of Physics*. Cambridge University Press, Cambridge, 1966.
- [140] Carl W. F. T. Pistorius, Martha C. Pistorius, J. P. Blakey, and L. J. Admiraal, "Melting Curve of Ice VII to 200 kbar." *J. Chem. Phys.*, **38**, 600–602 (1963).
- [141] Kenneth S. Pitzer, "Gilbert N. Lewis and the Thermodynamics of Strong Electrolytes." *J. Chem. Educ.*, **61**, 104–107 (1984).
- [142] Kenneth S. Pitzer and David A. Shirley, "William Francis GIAUQUE." In *Biographical Memoirs*, Vol. 69. National Academies Press, Washington, 1996.
- [143] Max Planck, *Treatise on Thermodynamics*, 3rd edition. Dover, Mineola, New York, 1990. Translation by Alexander Ogg of *Vorlesungen über Thermodynamik*, de Gruyter, Berlin, 1922.
- [144] Max Planck, "A Scientific Autobiography." In *Scientific Autobiography and Other Papers*. Williams and Norgate, London, 1950. Translation by Frank Gaynor of *Wissenschaftliche Selbstbiographie*, Barth, Leipzig, 1948.
- [145] R. F. Platford, "Oil-Water Partition Coefficients from Solvent Activities." *J. Solution Chem.*, **5**, 645–651 (1976).
- [146] H. Preston-Thomas, "The International Temperature Scale of 1990 (ITS-90)." *Metrologia*, **27**, 3–10 (1990).
- [147] William Ramsey, "Prof. François Marie Raoult." *Nature*, **64**, 17–18 (1901).
- [148] Merle Randall and Leona Esther Young, "The Calomel and Silver Chloride Electrodes in Acid and Neutral Solutions. The Activity Coefficient of Aqueous Hydrochloric Acid and the Single Potential of the Deci-Molal Calomel Electrode." *J. Am. Chem. Soc.*, **50**, 989–1004 (1928).
- [149] F. M. Raoult, "On the Vapor-Pressure of Ethereal Solutions." In Harry C. Jones, editor, *The Modern Theory of Solution: Memoirs by Pfeffer, van't Hoff, Arrhenius, and Raoult*, pages 95–121. Harper and Brothers, New York, 1899. Translation by Harry C. Jones of "Sur les Tensions de Vapeur des Dissolutions Faites dans l'Éther," *Ann. Chim. Phys.*, 6th Ser., **15**, 375–407 (1888).
- [150] F.-M. Raoult, "Sur les Tensions de Vapeur des Dissolutions." *Ann. Chim. Phys.*, 6th Ser., **20**, 297–371 (1890).
- [151] Joseph A. Rard and Donald G. Miller, "Isopiestic Determination of the Osmotic Coefficients of Aqueous Na₂SO₄, MgSO₄, and Na₂SO₄-MgSO₄ at 25°C." *J. Chem. Eng. Data*, **26**, 33–38 (1981).
- [152] T. R. Rettich, Rubin Battino, and Emmerich Wilhelm, "Solubility of Gases in Liquids. 22. High-Precision Determination of Henry's Law Constants of Oxygen in Liquid Water from

- $T = 274\text{ K}$ to $T = 328\text{ K}$." *J. Chem. Thermodyn.*, **32**, 1145–1156 (2000).
- [153] Timothy R. Rettich, Y. Paul Handa, Ruben Battino, and Emmerich Wilhelm, "Solubility of Gases in Liquids. 13. High-Precision Determination of Henry's Constants for Methane and Ethane in Liquid Water at 275 to 328 K." *J. Phys. Chem.*, **85**, 3230–3237 (1981).
- [154] R. A. Robinson and R. H. Stokes, *Electrolyte Solutions*, 2nd edition. Butterworths, London, 1959.
- [155] Frederick D. Rossini, "Heat of Formation of Hydrogen Chloride and some Related Thermodynamic Data." *J. Res. Natl. Bur. Stand. (U.S.)*, **9**, 679–702 (1932).
- [156] Benjamin Count of Rumford, "An Inquiry Concerning the Source of the Heat Which is Excited by Friction." *Philos. Trans. R. Soc. London*, **88**, 80–102 (1798).
- [157] R. L. Rusby, M. Durieux, A. L. Reesink, R. P. Hudson, G. Schuster, M. Kühne, W. E. Fogle, R. J. Soulen, and E. D. Adams, "The Provisional Low Temperature Scale from 0.9 mK to 1 K, PLTS-2000." *J. Low Temp. Phys.*, **126**, 633–642 (2002).
- [158] James R. Salvador, Fu Guo, Tim Hogan, and Mercurio G. Kanatzidis, "Zero Thermal Expansion in YbGaGe Due to an Electronic Valence Transition." *Nature*, **425**, 702–705 (2003).
- [159] George Scatchard and C. L. Raymond, "Vapor–Liquid Equilibrium. II. Chloroform–Ethanol Mixtures at 35, 45 and 55°." *J. Am. Chem. Soc.*, **60**, 1278–1287 (1938).
- [160] George Scatchard, W. J. Hamer, and S. E. Wood, "Isotonic Solutions. I. The Chemical Potential of Water in Aqueous Solutions of Sodium Chloride, Potassium Chloride, Sulfuric Acid, Sucrose, Urea and Glycerol at 25°." *J. Am. Chem. Soc.*, **60**, 3061–3070 (1938).
- [161] Francis Weston Sears and Mark W. Zemansky, *University Physics*, 4th edition. Addison-Wesley, Reading, Massachusetts, 1970.
- [162] Jan V. Sengers and Anneke Levelt Sengers, "The Critical Region." *Chem. Eng. News*, June 10, 104–118 (1968).
- [163] F. Hastings Smyth and Leason H. Adams, "The system, Calcium Oxide–Carbon Dioxide." *J. Am. Chem. Soc.*, **45**, 1167–1184 (1923).
- [164] Richard E. Sonntag and Gordon J. Van Wylen, *Introduction to Thermodynamics: Classical and Statistical*, 2nd edition. Wiley, New York, 1982.
- [165] Michael Stock, Richard Davis, Estefanía de Mirandés, and Martin J. T. Milton, "The Revision of the SI—the Result of Three Decades of Progress in Metrology." *Metrologia*, **56**, 022001 (2019).
- [166] Anthony N. Stranges, "William Francis Giauque: An Adventure in Low-Temperature Research." *J. Chem. Educ.*, **67**, 187–193 (1990).
- [167] Julian M. Sturtevant, "The Heat of Dilution of Aqueous Hydrochloric Acid at 25°." *J. Am. Chem. Soc.*, **62**, 3265–3266 (1940).
- [168] Craig Thornber, *Thomas Henry, FRS and his son, William Henry, MD, FRS, GS*. Online at <http://www.thornber.net/cheshire/ideasmen/henry.html>.
- [169] Hossein Toghiani, Rebecca K. Toghiani, and Dabir S. Viswanath, "Vapor-Liquid Equilibria for the Methanol-Benzene and Methanol-Thiophene Systems." *J. Chem. Eng. Data*, **39**, 63–67 (1994).
- [170] Andrzej Treszczanowicz, Teresa Treszczanowicz, Teresa Kasprzycka-Guttman, and Tomasz S. Pawlowski, "Excess Molar Volumes for (Binary Mixtures of 1-Alkanol and 1-Alkene). I. The System 1-Alkanol and 1-Octene at 25°C." *J. Solution Chem.*, **31**, 455–466 (2002).
- [171] Edwin E. Tucker, Edwin H. Lane, and Sherril D. Christian, "Vapor Pressure Studies of Hydrophobic Interactions. Formation of Benzene-Benzene and Cyclohexane-Cyclohexane Dimers in Dilute Aqueous Solution." *J. Solution Chem.*, **10**, 1–20 (1981).
- [172] R. Underwood, M. de Podesta, G. Sutton, L. Stranger, R. Rusby, P. Harris, P. Morantz, and G. Machin, "Further Estimates of $(T - T_{90})$ Close to the Triple Point of Water." *Int. J. Thermophys.*, **38**, 44 (2017).
- [173] Gijs van Ginkel, *Prof. Peter J. W. Debye (1884-1966) in 1935-1945: An Investigation of Historical Sources*, revised edition. RIPCN, The Netherlands, 2006. Online at

- <http://www.theochem.ru.nl/~pwormer/HistoricalsourcesDebye1935-1945.pdf>.
- [174] J. H. van't Hoff, "The Rôle of Osmotic Pressure in the Analogy between Solutions and Gases." In Harry C. Jones, editor, *The Modern Theory of Solution: Memoirs by Pfeffer, van't Hoff, Arrhenius, and Raoult*, pages 13–42. Harper and Brothers, New York, 1899.
Translation by Harry C. Jones of "Die Rolle des Osmotischen Druckes in der Analogie zwischen Lösungen und Gasen," *Z. Phys. Chem. (Leipzig)*, **1**, 481–508 (1887).
- [175] N. B. Vargaftik, B. N. Volkov, and L. D. Voljak, "International Tables of the Surface Tension of Water." *J. Phys. Chem. Ref. Data*, **12**, 817–820 (1983).
- [176] Donald D. Wagman and Marthada V. Kilday, "Enthalpies of Precipitation of Silver Halides; Entropy of the Aqueous Silver Ion." *J. Res. Natl. Bur. Stand. (U.S.)*, **77A**, 569–579 (1973).
- [177] Donald D. Wagman, William H. Evans, Vivian B. Parker, Richard H. Schumm, Iva Halow, Sylvia M. Bailey, Kenneth L. Churney, and Ralph L. Nuttall, "The NBS Tables of Chemical Thermodynamic Properties. Selected Values for Inorganic and C₁ and C₂ Organic Substances in SI Units." *J. Phys. Chem. Ref. Data*, **11**, Supplement No. 2 (1982).
- [178] Jingtao Wang and Mikhail A. Anisimov, "Nature of Vapor-Liquid Asymmetry in Fluid Criticality." *Phys. Rev. E*, **75**, 051107 (2007).
- [179] E. W. Washburn, *International Critical Tables of Numerical Data, Physics, Chemistry and Technology*, Vol. III. McGraw-Hill, New York, 1928.
- [180] E. W. Washburn, *International Critical Tables of Numerical Data, Physics, Chemistry and Technology*, Vol. IV. McGraw-Hill, New York, 1928.
- [181] E. W. Washburn, *International Critical Tables of Numerical Data, Physics, Chemistry and Technology*, Vol. VII. McGraw-Hill, New York, 1930.
- [182] Edward W. Washburn, "Standard States for Bomb Calorimetry." *J. Res. Natl. Bur. Stand. (U.S.)*, **10**, 525–558 (1933).
- [183] Lynde Phelps Wheeler, *Josiah Willard Gibbs: The History of a Great Mind*, revised edition. Yale University Press, New Haven, Connecticut, 1952.
- [184] Emmerich Wilhelm, Ruben Battino, and Robert J. Wilcock, "Low-Pressure Solubility of Gases in Liquid Water." *Chem. Rev.*, **77**, 219–262 (1977).
- [185] Jaime Wisniak, "Benoit Paul Emile Clapeyron: A Short Bibliographical Sketch." *Chem. Educator*, **5**, 83–87 (2000).
- [186] Mark W. Zemansky and Richard H. Dittman, *Heat and Thermodynamics: An Intermediate Textbook*, 7th edition. McGraw-Hill, New York, 1997.

INDEX

A page number followed by “b” is for a biographical sketch, one followed by “n” is for a footnote, and one followed by “p” is for a problem.

A

- Absolute zero, unattainability of, 164
 - Acid dissociation constant, 410
 - Acoustic gas thermometry, 45
 - Activity, 271, 408
 - of an electrolyte solute, 294
 - of a gas, 187, 274
 - of an ion, 290
 - of a mixture constituent, 274
 - of a pure liquid or solid, 274
 - relative, 271
 - of a solute, 274
 - of a solvent, 274
 - of a symmetrical electrolyte, 292
 - Activity coefficient, 259, 261
 - approach to unity, 262
 - of a gas, 187
 - from the Gibbs–Duhem equation, 267
 - of an ion, 289
 - from the Debye–Hückel theory, 297
 - mean ionic
 - from the Debye–Hückel theory, 297
 - of an electrolyte solute, 294
 - from the Nernst equation, 463
 - from the osmotic coefficient, 301
 - from solubility measurement, 391
 - of a symmetrical electrolyte, 291
 - from the osmotic coefficient, 268–269
 - of a solute
 - in dilute solution, 262
 - from gas fugacity, 264–266
 - of a solvent, 371n
 - from gas fugacity, 264–266
 - stoichiometric, 295
 - Activity quotient, 351
 - Additivity rule, 231, 235, 240, 244, 291, 293, 294, 305, 309, 330, 347
 - Adiabat, 80
 - Adiabatic
 - boundary, 28
 - calorimeter, 171–173, 335
 - demagnetization, 162, 164
 - flame temperature, 342–343
 - process, 52, 58, 98, 133
 - Advancement, 316
 - Affinity of reaction, 344n
 - Amount, 19, 20, 37, 471
 - measurement of, 37–38
 - Amount of substance, *see* Amount
 - Ampere, 471
 - Anisotropic phase, 30, 77
 - Antoine equation, 223p
 - Athermal process, 306
 - Atomic mass, relative, 37
 - Atomic weight, 37
 - Avogadro constant, 20, 21, 472
 - Azeotrope, 405, 435
 - minimum-boiling, 436
 - vapor-pressure curve, 436
 - Azeotropic behavior, 434
 - Azeotropy, 435
- ## B
- Bar, 40
 - Barometric formula, 199, 278
 - Barotropic effect, 33
 - Base units, 19, 470
 - Binary mixture, 226
 - in equilibrium with a pure phase, 375
 - Binary solution, 226

- Bivariant system, 202, 419
Body, 28
Boiling point, 206
 curve, 207, 433
 elevation in a solution, 376, 379–381
Boltzmann constant, 21, 44
Bomb calorimeter, 321, 334, 336–342
Bomb calorimetry, 362p
Boundary, 27
 adiabatic, 28
 diathermal, 28
Boyle temperature, 36
Brewer, Leo, 273
Bridgman, Percy, 182, 495
Bubble-point curve, 433
- C**
- Cailletet and Matthias, law of, 209
Caloric theory, 62
Calorie, 89n
Calorimeter, 171
 adiabatic, 171–173, 335
 bomb, 321, 334, 336–342
 Bunsen ice, 342
 combustion, 334
 constant-pressure, 173, 215
 constant-volume, 172
 continuous-flow, 176
 flame, 342
 heat-flow, 342
 isoperibol, 173, 335, 342
 isothermal-jacket, 173–176, 335, 342
 phase-change, 342
 reaction, 334–336
Calorimetry
 bomb, 336, 362p
 drop, 193p
 to evaluate an equilibrium constant, 355
 to measure heat capacities, 171
 to measure transition enthalpies, 215
 reaction, 324, 334–342, 410
Candela, 471
Carathéodory's principle of adiabatic
 inaccessibility, 122
Carnot
 cycle, 109, 109–112
 engine, 109, 109–112
 heat pump, 111
Carnot, Sadi, 110b
Cell
 diagram, 450
 electrochemical, 449
 galvanic, 449
 reaction, 451
 with transference, 451
 without liquid junction, 451
 without transference, 451
Cell potential, 92, 452
 equilibrium, 92
Celsius
 scale, 42
 temperature, 42
Center of mass, 500
Center-of-mass frame, 55, 59, 500–502
Centigrade scale, 42
Centrifugal force, 503, 504
Centrifuge, 276
 cell, 278–281
Charge
 electric, 452
 number, 297
Chemical amount, 20n
Chemical equation, 314
Chemical potential, 140, 146
 of an electrolyte solute, 294
 of electrons, 455
 as a function of T and p , 216
 of a liquid or solid, 188
 of a pure substance, 184
 of a solvent
 from the freezing point, 371–372
 from the osmotic coefficient, 370
 from osmotic pressure, 373–374
 of a species in a mixture, 237
 standard, 259, 271
 of a gas, 185
 of a gas constituent, 242
 of an ion, 289
 of a pure substance, 185
 of a symmetrical electrolyte, 291
 total, 199
Chemical process, 304
 subscript for, 478
Chemical work, 140
Circuit
 electrical, 89–91
 heater, 171, 172, 174, 175
 ignition, 338, 339
Clapeyron equation, 218
Clapeyron, Émile, 219b
Clausius
 inequality, 121
 statement of the second law, 107
Clausius, Rudolf, 106, 107, 113b, 131, 135
Clausius–Clapeyron equation, 221, 370

- CODATA, 505
Coefficient of thermal expansion, 166
Coexistence curve, 204, 216
 liquid–gas, 32
Colligative property, 376
 to estimate solute molar mass, 376
Common ion effect, 391, 444
Component, 421
Components, number of, 48, 230n
Composition variable, 225, 228
 relations at infinite dilution, 227
Compressibility factor, 35
Compression, 52
Compression factor, 35
Concentration, 29, 226
 standard, 255
Condensation curve, 433
Conditions of validity, 23n
Congruent melting, 428
Conjugate
 pair, 141
 phases
 in a binary system, 429
 in a ternary system, 442
 variables, 60, 141
Consolute point, 430
Constants, values of, 472
Contact
 force, 494
 potential, 455, 456
Continuity of states, 33
Convergence temperature, 174
Conversion factor, 23
Coriolis force, 279n, 503, 504
Coulomb’s law, 490
Critical
 curve, 439
 opalescence, 207
 point
 of partially-miscible liquids, 430
 of a pure substance, 32, 207
 pressure, 207
 temperature, 207
Cryogenics, 160–164
Cryoscopic constant, 379
Cubic expansion coefficient, 166, 212, 220
 of an ideal gas, 191p
 negative values of, 166n
Curie’s law of magnetization, 164
Current, electric, 89, 90, 171, 449, 471
Cyclic process, 53
- D**
- Dalton’s law, 241
Debye crystal theory, 156
Debye, Peter, 162, 295, 296b, 299, 300
Debye–Hückel
 equation
 for a mean ionic activity coefficient, 297, 299, 464
 for a single-ion activity coefficient, 297
 limiting law, 298, 332, 333, 391
 theory, 295–301
Defining constants, 20
Deformation, 30
 elastic, 36
 plastic, 36
 work, 71–77
Degree of dissociation, 410
Degrees of freedom, 202, 419
Deliquescence, 438
Density, 29
 measurement of, 39
Dependent variable, 47
Derivative, 480
 formulas, 480
Dew-point curve, 433
Dialysis, equilibrium, 396
Diathermal boundary, 28
Dielectric constant gas thermometry, 45
Dieterici equation, 26p
Differential, 24, 482
 exact, 53, 482
 inexact, 53
 total, 138, 482
 of the internal energy, 139–141
Dilution process, 325
Dimensional analysis, 24–25
Disorder, 134
Dissipation of energy, 66n, 68, 83, 86, 93–98, 117, 127, 133, 173
Dissipative work, 86, 92, 94, 98, 139
Dissociation pressure of a hydrate, 437
Distribution coefficient, 394
Donnan
 membrane equilibrium, 396, 396–399
 potential, 396
Doppler broadening thermometry, 45
Duhem–Margules equation, 404
- E**
- Ebullioscopic constant, 379
Efficiency
 of a Carnot engine, 114–117

- of a heat engine, 114
- Efflorescence, 438
- Einstein energy relation, 55, 185n
- Elastic deformation, 36
- Electric
 - charge, 452
 - current, 89, 90, 171, 449, 471
 - potential, 288, 300, 452
 - inner, 288, 452
 - potential difference, 90, 91, 396, 452
 - power, 176
 - resistance, 91, 171
- Electrical
 - circuit, 89–91
 - conductor of a galvanic cell, 449
 - force, 490
 - heating, 91–92, 171, 172, 176
 - neutrality, 238, 421
 - resistor, 61, 91, 92
 - work, 62, 89–93, 99, 171, 173, 176, 215, 339, 455
- Electrochemical
 - cell, 449
 - potential, 289n
- Electrode, 450
 - hydrogen, 450
 - standard, 465
 - potential, standard, 465
 - reaction, 451
- Electrolyte
 - solution, 287–302
 - symmetrical, 290–292
- Electromotive force, 453n
- Electron
 - chemical potential, 455
 - conductor of a galvanic cell, 449
 - number, 451
- Elementary charge, 21
- Elementary entity, 19
- Emf, 453n
- Endothermic reaction, 320
- Energy, 54, 489–496
 - dissipation of, 66n, 68, 83, 86, 93–98, 117, 127, 133, 173
 - Gibbs, 141
 - Helmholtz, 141
 - internal, 54, 54–55
 - kinetic, 489
 - potential, 491
 - of the system, 53–55
 - thermal, 63, 496
- Energy equivalent, 172, 173, 175, 335, 336, 339, 340
- Enthalpy, 141
 - change at constant pressure, 179
 - of combustion, standard molar, 337, 341
 - of dilution
 - integral, 328
 - molar differential, 328
 - molar integral, 328
 - of formation of a solute, molar, 329
 - of formation, standard molar, 321
 - of an ion, 322
 - of a solute, 322
 - of mixing to form an ideal mixture, 306
 - molar reaction, 316
 - molar, effect of temperature on, 324–325
 - partial molar, 250
 - in an ideal gas mixture, 244
 - relative, of a solute, 330
 - relative, of the solvent, 330
 - of a solute in an ideal-dilute solution, 259
 - reaction
 - standard molar, 320, 322, 369, 370, 410
 - standard molar of a cell reaction, 461
 - relative apparent, of a solute, 331
 - of solution
 - at infinite dilution, 326
 - integral, 327
 - molar differential, 326, 328, 386
 - molar integral, 327, 329, 358
 - of vaporization
 - molar, 213
 - standard molar, 215
- Entropy, 106, 123, 133
 - change
 - at constant pressure, 179
 - at constant volume, 178
 - an extensive property, 126
 - as a measure of disorder, 134
 - of mixing
 - to form an ideal mixture, 306, 308
 - negative value, 306
 - molar, 155–160
 - from calorimetry, 156
 - of a nonequilibrium state, 127
 - partial molar, 250
 - of a solute in an ideal-dilute solution, 258
 - reaction
 - standard molar, 410, 412p
 - standard molar of a cell reaction, 461
 - residual, 159–160

- scale
 - conventional, 158
 - practical, 158
 - standard molar, 158, 410
 - of a gas, 189, 243
 - third-law, 155
 - zero of, 153–155
- Equation
- chemical, 314
 - reaction, 314
 - stoichiometric, 315
- Equation of state, 47, 48
- of a fluid, 33
 - of a gas at low pressure, 35, 246, 247, 283p, 363p
 - of an ideal gas, 33
 - thermodynamic, 168
 - virial, 34
- Equilibrium
- dialysis, 396
 - gas–gas, 439
 - liquid–gas, 399–408
 - liquid–liquid, 391–395
 - mechanical, 49
 - phase transition, 71, 346
 - position, effect of T and p on, 357–359
 - reaction, 49, 344, 408–410
 - solid–liquid, 382–391
 - thermal, 49
 - transfer, 49
- Equilibrium cell potential, 92, 453
- Equilibrium conditions
- for a gas mixture in a gravitational field, 276–278
 - in a gravitational field, 198
 - in a multiphase multicomponent system, 238–239
 - in a multiphase one-component system, 196–197
 - for reaction, 344–350
 - for a solution in a centrifuge cell, 278–281
- Equilibrium constant
- mixed, 409
 - on a pressure basis, 353
 - thermodynamic, 352
 - of a cell reaction, 461
 - temperature dependence, 369
- Equilibrium state, 49, 49–51
- Euler reciprocity relation, 483
- Eutectic
- composition, 426
 - halt, 427
 - point, 426, 428, 429
 - temperature, 426–428
- Eutonic
- composition, 443
 - point, 443
- Exact differential, 53, 482
- Excess
- function, 150
 - quantity, 307
- Exergonic process, 304n
- Exothermic reaction, 320
- Expansion, 52
- free, 82
 - reversible, of an ideal gas, 130
 - work, 75, 75–82, 99
 - reversible, 80
- Expansivity coefficient, 166
- Extensive property, 28
- Extent of reaction, 316
- External field, 28, 50, 59, 197

F

- Faraday constant, 288, 452, 472
- Field
- external, 28, 50, 59, 197
 - gravitational, 28, 36, 50, 55, 197, 276
 - magnetic, 162, 164
- First law of thermodynamics, 57, 139
- Fluid, 31, 32–33
- isotropic, 39
 - supercritical, 32, 208, 212
- Flux density, magnetic, 162
- Force, 487–496
- apparent, 279n, 497
 - centrifugal, 503, 504
 - contact, 494
 - Coriolis, 279n, 503, 504
 - effective, 497
 - electrical, 490
 - fictitious, 279n, 497, 499
 - frictional, 72
 - gravitational, 36, 200, 490, 504
- Formation reaction, 320
- Frame
- center-of-mass, 55, 59, 500–502
 - lab, 54, 59, 60, 82, 276, 278, 488, 491–494, 496, 497, 499, 500
 - local, 54, 58, 59, 71, 82, 278, 280, 496–499
 - nonrotating, 499–502
 - rotating, 278, 497, 502–503
 - reference, 28, 54

- earth-fixed, 503–504
- inertial, 54, 487, 488, 491
- Free expansion, 82, 132–133
- Freezing point, 206
 - curve, 382
 - for a binary solid–liquid system, 426
 - of an ideal binary mixture, 385
 - for solid compound formation, 389
 - depression in a solution, 376–379
 - to evaluate solvent chemical potential, 371–372
 - of an ideal binary mixture, 382–385
- Friction
 - dry, 97
 - internal, 93–97
 - lubricated, 95
 - sliding, 495, 496
- Frictional force, 72
- Fugacity
 - effect of liquid composition on, 401–403
 - effect of liquid pressure on, 399
 - of a gas, 185
 - of a gas mixture constituent, 244
- Fugacity coefficient
 - of a gas, 187
 - of a gas mixture constituent, 245, 247
- Fundamental equation, Gibbs, 237
- Fundamental equations, Gibbs, 146, 288
- G**
- Galvani potential, 288, 452
- Galvanic cell, 92, 449
 - in an equilibrium state, 50
- Gas, 32
 - ideal, 77
 - mixture, 241, 243
 - perfect, 78n
 - solubility, 405–407
 - thermometry, 44–45
- Gas constant, 44, 472
- Gas–gas immiscibility, 439
- Giauque, William, 162, 163b
- Gibbs
 - equations, 143, 145
 - fundamental equation, 237
 - fundamental equations, 146, 288
 - phase rule
 - for a multicomponent system, 418–425
 - for a pure substance, 202
- Gibbs energy, 141
 - of formation, standard molar, 355
 - of an ion, 355
 - of mixing, 305
 - to form an ideal mixture, 306
 - molar, 305
 - molar, 145, 184
 - molar reaction, 343
 - of a cell reaction, 457–460
 - reaction, standard molar, 351, 410
 - total differential of, for a mixture, 237
- Gibbs, Josiah Willard, 146
- Gibbs, Willard, 142b
- Gibbs–Duhem equation, 232, 235, 236, 256, 267, 269, 301, 308, 388, 401
- Gibbs–Helmholtz equation, 368
- Gravitational
 - field, 28, 36, 50, 55, 197, 276
 - force, 36, 200, 490, 504
 - work, 82–84, 99
- Gravitochemical potential, 199
- H**
- Hückel, Erich, 295, 299, 300
- Heat, 57, 92, 495
 - flow in an isolated system, 131–132
 - reservoir, 51, 62, 108, 109, 111, 117, 119, 121, 123, 125, 128, 130, 132, 135
 - technical meaning of, 62
 - transfer, 69–71
- Heat capacity, 63, 146–147
 - at constant pressure, 63, 147
 - molar, 147
 - partial molar, 251
 - at constant volume, 63, 146
 - of an ideal gas, 78
 - molar, 147
 - at constant volume and constant pressure, relation between, 170
 - measurement of, by calorimetry, 171
 - molar reaction, 324
- Heat engine, 108, 109
- Heater circuit, 171, 172, 174, 175
- Heating
 - at constant volume or pressure, 176–179
 - curve, of a calorimeter, 172, 174, 175
 - electrical, 91–92, 171, 172, 176
 - reversible, 130
- Helium, 205n
- Helmholtz energy, 141
- Henry's law, 251
 - not obeyed by electrolyte solute, 287

- Henry's law constant, 251
effect of pressure on, 408
effect of temperature on, 407
evaluation of, 254
- Henry's law constants, relations between
different, 254
- Henry, William, 252b
- Hess's law, 321, 322, 337
- Hess, Germain, 323b
- Homogeneous phase, 30
- Hydrogen electrode, 450
standard, 465
- ## I
- Ice point, 42
for fixed temperature, 41
- Ice, high pressure forms, 205
- Ideal gas, 77
equation, 23, 33, 77
internal pressure, 169
mixture, 241, 243
in a gravitational field, 276–278
and Raoult's law, 250
- Ideal mixture, 250, 259–261
mixing process, 305
and Raoult's law, 249
- Ideal solubility
of a gas, 406
of a solid, 386
- Ideal-dilute solution, 254
partial molar quantities in, 258–259
solvent behavior in, 256–257, 402
- Ideal-gas temperature, 41, 117
- Ignition circuit, 338, 339
- Impossible process, 68
- Independent variables, 47, 195
of an equilibrium state, 122
number of, 201, 420
- Indicator diagram, 80
- Inertial reference frame, 54, 488, 491
- Inexact differential, 53
- Inner electric potential, 452
- Integral, 481
formulas, 481
line, 75, 481
- Integral enthalpy of dilution, 328
- Integral enthalpy of solution, 327
- Integrand, 481
- Integrating factor, 125
- Intensive property, 29
- Interface surface, 30
- Internal
friction, 93–97
pressure, 168, 168–169, 171
of an ideal gas, 169
resistance, 455
- Internal energy, 54, 54–55
of an ideal gas, 77
of mixing to form an ideal mixture, 306
partial molar, 251
- International prototype, 20, 37
- International System of Units, *see* SI
- International temperature scale of 1990, *see*
ITS-90
- International Union of Pure and Applied
Chemistry, *see* IUPAC
- Invariant system, 202, 419
- Ionic conductor of a galvanic cell, 449
- Ionic strength, 297, 298, 300
effect on reaction equilibrium, 409
- Irreversible process, 68, 105, 127–129, 131,
133
- Isobaric process, 52
- Isochoric process, 52
- Isolated system, 28, 49
spontaneous changes in, 131
- Isoperibol calorimeter, 173, 335, 342
- Isopiestic
process, 52
solution, 270
vapor pressure technique, 270
- Isopleth, 427
- Isoteniscope, 206
- Isotherm, 80, 211
- Isothermal
bomb process, 337, 338–340, 341
compressibility, 166, 211, 212, 220
of an ideal gas, 191p
of a liquid or solid, 183
magnetization, 162, 164
pressure changes, 182–183
of a condensed phase, 183
of an ideal gas, 183
process, 52
- Isotropic fluid, 39
- Isotropic phase, 30
- ITS-90, 43, 46
- IUPAC, 19
- IUPAC Green Book, 19, 141, 184, 213,
262n, 325, 352, 453n, 470
- ## J
- Johnson noise thermometry, 45
- Joule

- coefficient, 191p
 - experiment, 191p
 - paddle wheel, 87–89, 107
 - Joule, James Prescott, 59, 63, 87, 88b, 103p, 191p
 - Joule–Kelvin
 - coefficient, 161
 - experiment, 160
 - Joule–Thomson
 - coefficient, 161, 182
 - experiment, 160
- K**
- Kelvin (unit), 41, 470
 - Kelvin, Baron of Largs, 106, 108, 117, 118b
 - Kelvin–Planck statement of the second law, 108, 121
 - Kibble balance, 37
 - Kilogram, 36, 470
 - international prototype, 20, 37
 - Kinetic energy, 489
 - Kirchhoff equation, 325, 340
 - Konowaloff’s rule, 405
- L**
- Lab frame, 54, 59, 60, 82, 276, 278, 488, 491–494, 496, 497, 499, 500
 - Laplace equation, 200, 282p
 - Law
 - of Cailletet and Matthias, 209
 - of rectilinear diameters, 209
 - scientific, 57
 - Le Châtelier’s principle, 358, 359
 - Legendre transform, 141, 145, 164, 485, 485–486
 - Lever rule, 210, 426
 - for a binary phase diagram, 427
 - general form, 211
 - for one substance in two phases, 209
 - for partially-miscible liquids, 430
 - for a ternary system, 442
 - Lewis and Randall rule, 283p
 - Lewis, Gilbert Newton, 109, 153, 272b, 297
 - Line integral, 75, 481
 - Liquid, 32
 - Liquid junction, 449, 451, 457
 - potential, 451, 457
 - Liquidus curve, 428
 - for a binary system, 426
 - for a binary liquid–gas system, 431, 433–435
 - for a binary solid–liquid system, 426
 - at high pressure, 438
- Liter**, 38
- Local frame, 54, 58, 59, 71, 82, 278, 280, 496–499
 - nonrotating, 499, 501, 502
 - rotating, 497
- M**
- Magnetic
 - enthalpy, 164
 - field, 162, 164
 - flux density, 162
 - Magnetization, isothermal, 162, 164
 - Mass, 470
 - measurement of, 36–37
 - Mass fraction, 225
 - Maxwell relations, 144
 - Maxwell, James Clerk, 41
 - McMillan–Mayer theory, 263n
 - Mean ionic activity coefficient, *see* Activity coefficient, mean ionic
 - Mean molar volume, 232
 - Melting point, 206
 - for fixed temperature, 41
 - Membrane equilibrium
 - Donnan, 396, 396–399
 - osmotic, 395
 - Membrane, semipermeable, 50, 373
 - Metastable state, 51
 - Meter, 470
 - Method of intercepts, 232, 234
 - Metre, 470
 - Microstate, 134
 - Milliliter, 38
 - Minimal work principle, 94
 - Miscibility gap
 - in a binary system, 314, 429
 - in a ternary system, 442
 - Mixing process, 304
 - Mixture
 - binary, 226
 - of fixed composition, 228
 - gas, in a gravitational field, 276–278
 - ideal, 259–261
 - and chemical potential, 250
 - and Raoult’s law, 249
 - simple, 310
 - Molal boiling-point elevation constant, 379
 - Molal freezing-point depression constant, 379
 - Molality, 226

- standard, 255
- Molar
- differential reaction quantity, 318
 - excess quantity, 307
 - integral reaction quantity, 318
 - mass, 38
 - from a colligative property, 376
 - from sedimentation equilibrium, 281
 - quantity, 29, 178
 - reaction quantity, 318
 - standard, 319
- Mole, 19, 37, 471
- Mole fraction, 225
 - standard, 256
- Mole ratio, 227
- Molecular mass, relative, 37
- Molecular weight, 37
- ## N
- Natural variables, 141, 144, 145
- Nernst
- distribution law, 394
 - equation, 462
 - heat theorem, 153
- Nernst, Walther, 153n, 154b
- Neutrality, electrical, 238, 421
- Newton's law of cooling, 174
- Newton's law of universal gravitation, 490
- Newton's second law of motion, 72, 200, 488
- Newton's third law of action and reaction, 489, 490, 498
- Nonexpansion work, 139, 149
- Normal
- boiling point, 207
 - melting point, 207
- ## O
- Osmosis, 373
- Osmotic coefficient, 268, 382
 - evaluation, 271
 - of a mean ionic activity coefficient, 301
- Osmotic membrane equilibrium, 395
- Osmotic pressure, 50, 373, 376, 381–382, 396
 - to evaluate solvent chemical potential, 373–374
 - van't Hoff's equation for, 382
- ## P
- Paddle wheel, 61
 - Joule, 87–89, 107
- Partial
- specific quantity, 237
 - specific volume, 237
- Partial derivative, 480
 - expressions at constant T , p , and V , 179–182
- Partial molar
- enthalpy, 250
 - in an ideal gas mixture, 244
 - relative, of a solute, 330
 - relative, of the solvent, 330
 - of a solute in an ideal-dilute solution, 259
 - entropy, 250
 - in an ideal gas mixture, 243
 - of a solute in an ideal-dilute solution, 258
 - Gibbs energy, 146
 - heat capacity at constant pressure, 251
 - internal energy, 251
 - quantity, 228
 - of a gas mixture constituent, 246
 - in general, 235
 - general relations, 239–241
 - in an ideal mixture, 250–251
 - in an ideal-dilute solution, 258–259
 - volume, 229–230, 251
 - in an ideal gas mixture, 244
 - interpretation, 230
 - negative value of, 230
- Partial pressure, 241
 - in an ideal gas mixture, 242
- Partition coefficient, 394
- Pascal (unit), 40
- Path, 51
- Path function, 53, 62
- Peritectic point, 429
- Perpetual motion of the second kind, 108n
- Phase, 30
 - anisotropic, 30, 77
 - boundary, 204
 - coexistence, 31
 - homogeneous, 30
 - isotropic, 30
 - rule, *see* Gibbs phase rule
 - separation of a liquid mixture, 312–314, 392, 429
 - transition, 31
 - equilibrium, 31, 71, 155, 346
- Phase diagram
 - for a binary liquid–gas system, 431

- for a binary liquid–liquid system, 429
 - for a binary solid–gas system, 436
 - for a binary solid–liquid system, 426
 - for a binary system, 425
 - at high pressure, 438
 - of a pure substance, 202
 - for a ternary system, 440
- Physical constants, values of, 472
- Physical quantities, symbols for, 473–476
- Physical state, 30
- symbols for, 477
- Pitzer, Kenneth, 273
- Plait point, 442
- Planck constant, 20
- Planck, Max, 106, 108, 120b
- Plasma, 32
- Plastic deformation, 36
- Plimsoll mark, 184
- PLTS-2000, 46
- Potential
- chemical, 140
 - electric, 452
 - energy, 491
 - function, 490
 - standard cell, 460, 462
 - evaluation of, 463–464
 - thermodynamic, 138
- Potentiometer to measure equilibrium cell potential, 454
- Poynting factor, 400
- Prefixes, 22
- Pressure
- changes, isothermal, 182–183
 - of a condensed phase, 183
 - of an ideal gas, 183
 - dissociation, of a hydrate, 437
 - internal, 168, 168–169, 171
 - in a liquid droplet, 200
 - measurement of, 39–40
 - negative, 169n
 - partial, 241
 - standard, 40, 183, 276, 360p, 467p
 - sublimation, 206
 - vapor, *see* Vapor pressure
- Pressure factor, 273, 274–276
- of an electrolyte solute, 294
 - of an ion, 290
 - of a symmetrical electrolyte, 292
- Pressure–volume diagram, 80
- Primary thermometry, 43–45
- Process, 51
- adiabatic, 52, 58, 98, 133
 - chemical, 304
 - subscript for, 478
 - compression, 52
 - cyclic, 53
 - dilution, 325
 - expansion, 52
 - impossible, 68, 105, 106–108
 - irreversible, 68, 105, 127–129, 131, 133
 - isenthalpic, 161
 - isobaric, 52
 - isochoric, 52
 - isopiestic, 52
 - isothermal, 52
 - mechanical, 133
 - mixing, 304
 - purely mechanical, 69
 - quasistatic, 65
 - reverse of a, 65
 - reversible, 63, 63–68, 97–98, 105, 106, 133
 - solution, 325
 - spontaneous, 63, 65, 66, 68, 69, 105, 133, 344
 - throttling, 160
- Product, 315
- Proper quotient, 352
- Property
- extensive, 28
 - intensive, 29
 - molar, 178
- Provisional low temperature scale of 2000, *see* PLST-2000
- ## Q
- Quantity
- molar, 29
 - specific, 29
- Quantity calculus, 22
- Quasicrystalline lattice model, 310
- Quasistatic process, 65
- ## R
- Randall, Merle, 109, 153, 297
- Raoult's law
- deviations from, 402–403, 434
 - for fugacity, 249
 - in a binary liquid mixture, 402
 - in an ideal-dilute solution, 257
 - for partial pressure, 248, 249
 - in a binary system, 431
- Raoult, François, 248
- Raoult, François-Marie, 380b

- Reactant, 315
- Reaction
- between pure phases, 345–346
 - cell, 451
 - endothermic, 320
 - equation, 314
 - equilibrium, 408–410
 - exothermic, 320
 - in a gas phase, 353–354
 - in an ideal gas mixture, 347–350
 - in a mixture, 346–347
 - quotient, 351, 462
 - in solution, 354
- Reaction quantity
- molar, 318
 - molar differential, 318
 - molar integral, 318
- Reciprocity relation, 144, 151p, 483
- Rectilinear diameters, law of, 209
- Redlich–Kister series, 311
- Redlich–Kwong equation, 26p, 33
- Reduction to standard states, 337
- Reference frame, 28, 54
- earth-fixed, 503–504
 - inertial, 487
- Reference state, 259
- of an element, 320
 - of an ion, 289
 - of a mixture constituent, 261
 - of a solute, 255–256, 262
 - of a solvent, 261
- Regular solution, 311
- Relative activity, 271
- Relative apparent molar enthalpy of a solute, 331
- Relative atomic mass, 37
- Relative molecular mass, 37
- Relative partial molar enthalpy
- of a solute, 330
 - of the solvent, 330
- Residual entropy, 159–160
- Resistance
- electric, 91, 171
 - internal, 455
- Resistor, electrical, 61, 91, 92
- Retrograde
- condensation, 439
 - vaporization, 439
- Reverse of a process, 65
- Reversibility
- internal, 68
- Reversible
- adiabatic expansion of an ideal gas, 78
 - adiabatic surface, 123
 - expansion and compression, 73
 - expansion of an ideal gas, 130
 - expansion work, 80
 - heating, 130
 - isothermal expansion of an ideal gas, 78
 - phase transition, 71
 - process, 63, 63–68, 97–98, 105, 106, 133
 - work, 97
- Rotating local frame, 278, 502–503
- Rubber, thermodynamics of, 152p
- Rumford, Count, 62, 64b
- ## S
- Salt bridge, 457
- Salting-out effect on gas solubility, 405, 414p
- Saturated solution, 385
- Saturation
- temperature, 206
 - vapor pressure, 205
- Second, 470
- Second law of thermodynamics
- Clausius statement, 107
 - equivalence of Clausius and Kelvin–Planck statements, 112–114
 - Kelvin–Planck statement, 108, 121, 125
 - mathematical statement, 106, 130
 - derivation, 122–126
- Sedimentation equilibrium, 281
- Shaft work, 84, 84–89
- Shear stress, 30
- SI, 19
- 2019 revision, 20–21, 37, 42
 - base units, 20, 470
 - derived units, 21
 - prefixes, 22
- Simple mixture, 310
- Solid, 30, 36
- viscoelastic, 31
- Solid compound, 387, 428, 436
- of mixture components, 387–389
- Solidus curve for a binary system, 426
- Solubility
- curve, 382
 - for a binary solid–liquid system, 426
 - of a gas, 405–407
 - ideal, 406
 - of a liquid, relation to Henry’s law constant, 394
 - of a solid, 385

- of a solid electrolyte, 389–391
- of a solid nonelectrolyte, 385–386
- Solubility product, 390, 461
 - temperature dependence, 391
- Solute, 226
 - reference state, 255–256, 262
- Solution, 226
 - binary, 226
 - in a centrifuge cell, 278–281
 - ideal-dilute, 254
 - multisolute electrolyte, 294
 - process, 325
 - regular, 311
 - saturated, 385
 - solid, 247, 428
- Solvent, 226
 - activity coefficient of, 371n
 - behavior in an ideal-dilute solution, 256–257, 402
- Species, 225, 419
- Specific
 - quantity, 29
 - volume, 29
- Spontaneous process, 63, 65, 66, 68, 69, 105, 133, 344
- Standard
 - boiling point, 207
 - cell potential, 460, 462
 - evaluation, 463–464
 - chemical potential, *see* Chemical potential, standard
 - composition, 255
 - concentration, 255
 - electrode potential, 465
 - hydrogen electrode, 465
 - melting point, 207
 - molality, 255
 - mole fraction, 256
 - pressure, 40, 183, 276, 360p, 467p
- Standard molar
 - properties, values of, 505–507
 - quantity, 188
 - evaluation of, 410–411
 - of a gas, 188–190
 - reaction quantity, 319
- Standard state
 - of a gas, 184
 - of a gas mixture constituent, 242
 - of an ion, 289
 - of a mixture component, 271
 - of a pure liquid or solid, 184
 - of a pure substance, 184
- State
 - of aggregation, 30, 477
 - equilibrium, 49, 49–51
 - metastable, 51
 - physical, 30, 477
 - standard, *see* Standard state
 - steady, 51
 - of a system, 46, 46–51
- State function, 47, 47–48
 - change of, 52
- Statistical mechanics, 34, 134, 135
 - Boyle temperature, 36
 - Debye crystal theory, 156
 - Debye–Hückel theory, 299
 - ideal mixture, 263
 - McMillan–Mayer theory, 263n
 - mixture theory, 310
 - molar entropy of a gas, 158
 - molar heat capacity of a metal, 156
 - second virial coefficient, 247
 - virial equations, 34
- Steady state, 51
- Steam engine, 111
- Steam point, 41, 42, 207
- Stirring work, 85, 85–87
- Stoichiometric
 - activity coefficient, 295
 - addition compound, *see* Solid compound
 - coefficient, 317
 - equation, 315
 - number, 317, 322, 351
- Sublimation
 - point, 206
 - pressure, 206
 - temperature, 206
- Subscripts for chemical processes, 478
- Substance, 225
- Subsystem, 28
- Supercritical fluid, 32, 208, 212
- Superscripts, 479
- Supersystem, 28, 119, 121, 123, 125, 128, 129
- Surface tension, 147
- Surface work, 147–148
- Surroundings, 27
- Symbols for physical quantities, 473–476
- System, 27
 - closed, 28
 - isolated, 28, 49
 - open, 28, 230, 237
 - state of, 46, 46–51
- System point, 204
- Système International d'Unités, *see* SI

T

Temperature

- Boyle, 36
- convergence, 174
- critical, 207
- equilibrium systems for fixed values, 41
- ideal-gas, 41, 117, 169
- international scale of 1990, *see* ITS-90
- measurement of, 40–46
- provisional scale of 2000, *see*
 - PLST-2000
- scales, 41–43
- thermodynamic, 41, 117, 117, 169, 470
- upper consolute, 429
- upper critical solution, 430

Temperature scale, 40

Thermal

- analysis, 427
- conductance, 174
- energy, 63, 496
- reservoir, 51

Thermocouple, 456n

Thermodynamic

- equation of state, 168
- equilibrium constant, 352
- potential, 138
- temperature, 41, 117, 117, 169, 470

Thermometer

- Beckmann, 46
- constant-volume gas, 44
- liquid-in-glass, 40, 46
- optical pyrometer, 46
- platinum resistance, 46
- quartz crystal, 46
- resistance, 46
- thermistor, 46
- thermocouple, 46
- thermopile, 46

Thermometry

- acoustic gas, 45
- dielectric constant gas, 45
- Doppler broadening, 45
- gas, 44–45
- Johnson noise, 45
- primary, 43–45

Thermopile, 342, 456n

Third-law entropy, 155

Third law of thermodynamics, 123, 153

Thompson, Benjamin, 62, 64b

Thomson, William, 108, 118b

Throttling process, 160

Tie line, 205

on a binary phase diagram, 426

on a ternary phase diagram, 442

Torque, 85

Total differential, 138, 482

- of the Gibbs energy of a mixture, 237
- of the Gibbs energy of a pure substance, 184
- of the internal energy, 139–141
- of the volume, 230

Triple

- line, 98n, 204
- point, 204
 - cell, 41
 - for fixed temperature, 41
 - of H₂O, 41, 42

U

Ultracentrifuge, 278–281

Units, 22

- Non-SI, 21
- SI, 20
- SI derived, 21

Univariant system, 202, 419

Upper consolute temperature, 429

Upper critical solution temperature, 430

V

van't Hoff, Jacobus, 383b

van't Hoff equation, 370

van't Hoff's equation for osmotic pressure, 382

Vapor, 32

Vapor pressure, 205

- curve, 207
- of a liquid droplet, 400
- lowering in a solution, 376, 381
- saturation, 205

Vaporization, 370

- molar enthalpy of, 213
- molar heat of, 213

Vaporus curve

- for a binary system, 426
- for a binary liquid–gas system, 431, 434, 435
- at high pressure, 438

Variables

- conjugate, 141
- dependent, 47
- independent, 47
- natural, 141, 144, 145
- number of independent, 48

- Variance, 202, 419
- Virial
- coefficient, 34
 - equation
 - for a gas mixture, 246
 - for a pure gas, 34
- Virtual displacement, 197
- Viscoelastic solid, 31
- Volume
- mean molar, 232
 - measurement of, 38
 - of mixing to form an ideal mixture, 306
 - molar, 29, 39
 - partial molar, 251
 - in an ideal gas mixture, 244
 - specific, 29
 - total differential in an open system, 230

W

- Washburn corrections, 340, 341–342, 364p
- Watt balance, 37
- Work, 57, 58–60, 488–496
- chemical, 140
 - coefficient, 60
 - coordinate, 60, 122
 - deformation, 71–77
 - dissipative, 86, 92, 94, 98, 139
 - of electric polarization, 99
 - electrical, 62, 89–93, 99, 171, 173, 176, 215, 339, 455
 - expansion, 75, 75–82, 99
 - gravitational, 82–84, 99
 - of magnetization, 99, 162
 - mechanical, 99
 - nonexpansion, 139, 149
 - reversible, 97
 - reversible expansion, 80
 - shaft, 84, 84–89, 99
 - stirring, 85, 85–87
 - stretching, 99
 - surface, 99, 147–148
- Working substance, 109, 117

Z

- Zeotropic behavior, 436
- Zeroth law of thermodynamics, 41